

TM 11-5820-461-12

DEPARTMENT OF THE ARMY TECHNICAL MANUAL

OPERATOR'S AND ORGANIZATIONAL MAINTENANCE MANUAL

RADIO SETS

AN/GRC-50(V)1 (NSN 5820-00-892-3851)
AN/GRC-50(V)2 (NSN 5820-00-892-3852)
AN/GRC-50(V)3 (NSN 5820-00-892-3853)
AN/GRC-50(V)4 (NSN 5820-00-892-3854)
AN/GRC-50(V)5 (NSN 5820-00-892-3855)
AN/GRC-50A(V)1 (NSN 5820-00-933-6193) AN/GRC-50A(V)6 (NSN 5820-00-936-5480)
AN/GRC-50A(V)2 (NSN 5820-00-933-6192) AN/GRC-50A(V)7 (NSN 5820-00-936-5481)
AN/GRC-50A(V)3 (NSN 5820-00-933-6191) AN/GRC-50A(V)8 (NSN 5820-00-935-0089)
AN/GRC-50A(V)4 (NSN 5820-00-933-6190) AN/GRC-50A(V)9 (NSN 5820-00-878-8635)
AN/GRC-50A(V)5 (NSN 5820-00-933-6189) AN/GRC-50A(V)10 (NSN 5820-00-878-8634)
AN/GRC-50A(V)11 (NSN 5820-00-136-4966)

This copy is a reprint which includes current pages from Changes 1 through 7.

HEADQUARTERS, DEPARTMENT OF THE ARMY
OCTOBER 1966

WARNING

Dangerous voltages exist in this equipment.

DON'T TAKE CHANCES!

DANGEROUS VOLTAGES EXIST IN THE ANTENNA SYSTEM

Be careful when working around the antenna or the antenna terminals. Radio frequency high voltages exist at these points.

**FIXED PERATION WITH LONG RANGE ANTENNAS
WARNING**

**FIXED OPERATION WITH LONG RANGE ANTENNAS
WARNING**

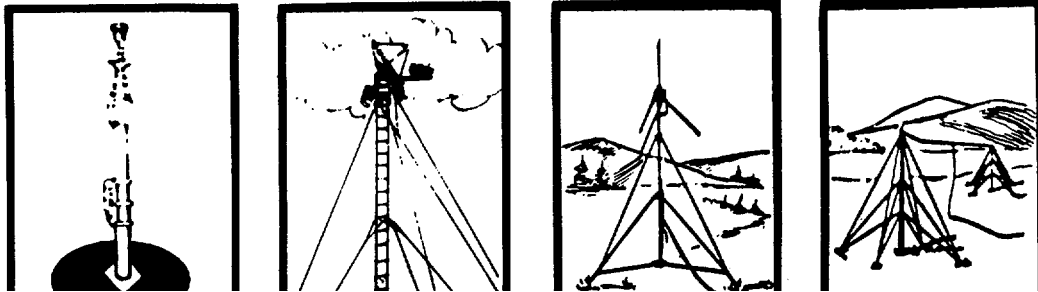

NEVER ERECT THESE LONG RANGE ANTENNAS DIRECTLY UNDER POWER LINES.

IF YOU MUST ERECT THESE LONG RANGE ANTENNAS NEAR POWERLINES, POWER LINE POLES OR TOWERS, OR BUILDINGS WITH OVERHEAD POWERLINE CONNECTIONS, NEVER PUT THE ANTENNA CLOSER THAN TWO TIMES THE ANTENNA HEIGHT FROM THE BASE OF THE POWERLINE, POLE, TOWER OR BUILDINGS.

NEVER ATTEMPT TO ERECT ANY LONG RANGE ANTENNA WITHOUT A FULL TEAM.

BEFORE ERECTING ANY LONG RANGE ANTENNA, INSPECT ALL THE PARTS MAKING UP THE ANTENNA KIT. DO NOT ERECT THE ANTENNA IF ANY PARTS ARE MISSING OR DAMAGED.

DO AS MUCH OF THE ASSEMBLY WORK AS POSSIBLE ON THE GROUND.

WHEN ERECTING THE ANTENNA, ALLOW ONLY TEAM PERSONEL IN THE ERECTION AREA.

MAKE SURE THAT THE AREA FOR THE ANCHORS IS FIRM. IF THE GROUND IS MARSHY OR SANDY, GET SPECIFIC INSTRUCTIONS FROM YOUR CREW CHIEF OR SUPERVISOR ON HOW TO REINFORCE THE ANCHORS.

WHEN SELECTING LOCATIONS FOR ANCHORS, AVOID TRAVELED AREAS AND ROADS. IF YOU CANNOT AVOID THESE AREAS, GET SPECIFIC INSTRUCTIONS FROM YOUR SUPERVISOR AS TO WHAT CLEARANCE YOUR GUY WIRES AND ROPES MUST HAVE OVER THE TRAVELED AREAS AND ROAD.

CLEARLY MARK ALL GUY WIRES AND ROPES WITH THE WARNING FLAGS OR SIGNS SUPPLIED BY YOUR UNIT. IN AN EMERGENCY, USE STRIPS OF WHITE CLOTH AS WARNING STREAMERS.

IF YOU SUSPECT THAT POWERLINES HAVE MADE ACCIDENTAL CONTACT WITH YOUR ANTENNA, STOP OPERATING, ROPE OFF THE ANTENNA AREA, AND NOTIFY YOUR SUPERIORS.

IF THE WEATHER IN YOUR AREA CAN CAUSE ICE TO FORM ON YOUR LONG RANGE ANTENNA AND ITS GUY WIRES AND ROPES, ADD EXTRA GUY TO SUPPORT THE SYSTEM. ROPE OFF THE AREA AND POST IT WITH WARNING SIGNS LIKE "BEWARE OF FALLING ICE."

DO NOT TRY TO ERECT ANY ANTENNA DURING AN ELECTRICAL STORM.

KEEP A SHARP EYE ON YOUR ANCHORS AND GUYS. CHECK THEM DAILY AND IMMEDIATELY BEFORE AND AFTER BAD WEATHER.



5

SAFETY STEPS TO FOLLOW IF SOMEONE IS THE VICTIM OF ELECTRICAL SHOCK

1

DO NOT TRY TO PULL OR GRAB THE INDIVIDUAL

2

IF POSSIBLE, TURN OFF THE ELECTRICAL POWER

3

IF YOU CANNOT TURN OFF THE ELECTRICAL POWER, PULL, PUSH, OR LIFT THE PERSON TO SAFETY USING A DRY WOODEN POLE OR A DRY ROPE OR SOME OTHER INSULATING MATERIAL

4

SEND FOR HELP AS SOON AS POSSIBLE

5

AFTER THE INURED PERSON IS FREE OF CONTACT WITH THE SOURCE OF ELECTRICAL SHOCK, MOVE THE PERSON A SHORT DISTANCE AWAY AND IMMEDIATELY START ARTIFICIAL RESUSCITATION

WARNING

Dangerous voltages exist in this equipment

**DON'T TAKE CHANCES!
DANGEROUS VOLTAGES EXIST IN THE ANTENNA SYSTEM**

Be careful when working around the antenna or the antenna terminals and cables. Radiofrequency high voltages exist in these areas.

Personnel working with Mast AB-577/GRC should be familiar with the requirements of TB SIG 291 before attempting installation and disassembly of the AB-577/GRC. Failure to follow the requirements of TB SIG 291 could result in injury or death.

WARNINGS

The use of more than one 25 foot mast extension kit (MK-806/GRC) on the Antenna Mast AB-577/GRC is hazardous and not authorized. Injury to personnel and damage to equipment are likely to occur when a second mast extension is used to extend the antenna mast beyond a height of 75 feet.

Adequate ventilation should be provided while using TRICHLOROTRIFLUOROETHANE. Prolonged breathing of vapor should be avoided. The solvent should not be used near heat or open flame; the products of decomposition are toxic and irritating. Since TRICHLOROTRIFLUOROETHANE dissolves natural oils, prolonged contact with skin should be avoided. When necessary, use gloves which the solvent cannot penetrate. If the solvent is taken internally, consult a physician immediately.

Operator's and
Organizational Maintenance Manual

**RADIO SETS AN/GRC-50(V) 1, 2, 3, 4, AND
 AND**

**RADIO SETS AN/GRC-50A(V)1, 2, 3, 4, 5, 6, 7, 8,
 9, 10, AND 11**

		Paragraph	Page
CHAPTER	1.	INTRODUCTION	
	I.	General	
		Scope	1-1
		Indexes of publications	1-1
		Forms and records.....	1-3
	II.	Description and data	
		Purpose and use.....	1-4
		Technical characteristics.....	1-5
		Components of radio sets	1-6
		Description of radio set	1-7
		Transmitting equipment	1-8
		Receiving equipment	1-9
		Antenna components	1-10
		Regulator, Voltage CN-514/GRC	1-11
		Minor components	1-12
		Additional equipment required.....	1-13
		Differences in models and configurations.....	1-14
	III.	System application	
		General.....	1-15
		Two-terminal system.....	1-16
		Repeater station system.....	1-17
		Interoperation with Radio Set AN/TRC-24 Configurations, fdm operation only.....	1-18
CHAPTER	2.	INSTALLATION	
Section	I.	Service upon receipt of equipment	
		Unpacking.....	2-1
		Checking unpacked equipment	2-2
	II.	Installation	
		Preliminary installation data	2-3
		Shelter requirements.....	2-4
		Tools required for installation	2-5
		Antenna site.....	2-6
		Antenna AT-903/G adjustment.....	2-7
		Cable connections and grounding	2-8
		Wavemeter vernier scale interpretation	2-9

This manual supersedes so much of TM 11-5820 461-10, 22 Juno 1962, including C 2, 2 December 1463, C 3, 2 July 1964, and C 4, 14 December 1964; and TM 11-5820-461-20, 22 June. 1962, Including C 1, 28 March 1963, as pertains to AN/GRC-50(V)1, 2, 3, 4, and 5, except Mast AB-577/GRC.

		Paragraph	Page
CHAPTER	3. OPERATING INSTRUCTIONS		
Section.	I. Operator's controls and indicators	3-1	3-1
	Transmitter controls and indicators	3-1	3-1
	Receiver controls and indicators	3-2	3-3
	Regulator, Voltage CN-514/GRC controls and indicators.....	3-3	3-4
	II. Tuning procedures		
	General		
	Installation of tuning units		
	Determination of channel frequency.....	3-6	3-14
	Preliminary starting procedures.....	3-7	3-14
	Receiver tuning procedures	3-8	3-15
	Transmitter tuning requirements	3-9	3-19
	Transmitter tuning procedures.....	3-10	3-20
	Single stack loop-back operational tests.....	3-11	3-27
	III. System lineup procedures		
	General.....	3-12	3-30
	Fdm system lineup.....	3-13	3-31
	Pcm system lineup.....	3-14	3-32
	System checks and adjustments	3-15	3-33
	Multiplex terminal adjustments.....	3-16	3-34
	IV. Routine operating procedures		
	General.....	3-17	3-34
	Order wire operation	3-18	3-34
	Monitoring equipment	3-19	3-35
	Stopping procedure.....	3-20	3-36
CHAPTER	4. OPERATOR'S MAINTENANCE		
Section	I. Maintenance		
	Scope of operator's maintenance	4-1	4-1
	Operator's preventive maintenance.....	4-2	4-1
	Preventive maintenance checks and services periods.....	4-3	4-1
	Daily preventive maintenance checks and services chart.....	4-4	4-2
	Weekly preventive maintenance checks and services chart.....	4-5	4-2
	Cleaning	4-6	4-3
	Visual inspection.....	4-7	4-3
	Operational checklist.....	4-8	4-3
	Replacement of indicator lamps.....	4-9	4-5
	Replacement of aid filter.....	4-11	4-5
CHAPTER	5. ORGANIZATIONAL MAINTENANCE		
Section	I. Maintenance		
	Scope of organizational maintenance	5-1	5-1
	Tools, materials, and test equipment required	5-2	5-1
	Organizational preventive maintenance	5-3	5-1
	Quarterly maintenance.....	5-4	5-1
	Quarterly maintenance service and inspection chart	5-5	5-2
	Additional maintenance items	5-6	5-3
	Lubrication	5-7	5-3
	II. Troubleshooting and repairs		
	General instructions.....	5-8	5-6
	Organization of troubleshooting procedures	5-9	5-6
	Visual inspection.....	5-10	5-6.1
	Equipment performance checklist	5-11	5-6.1
	Trouble sectionalizing chart	5-12	5-23
	Repairs and adjustments.....	5-13	5-24
	Tube replacement procedures.....	5-14	5-26
	Repairs	5-15	5-27

		Paragraph	Page
CHAPTER	6.	SHIPMENT, LIMITED STORAGE, AND DESTRUCTION TO PREVENT ENEMY USE	
		Disassembly of equipment	6-1 6-1
		Removal of equipment.....	6-2 6-2
		Repackaging for shipment and limited storage.....	6-3 6-2
		Packaging	6-4 6-2
		Destruction of army materiel to prevent enemy use (Electronics Command).....	6-5 6-3
APPENDIX	A.	REFERENCES	A-1
	B.	Not used.	
	C.	MAINTENANCE ALLOCATION	C-1

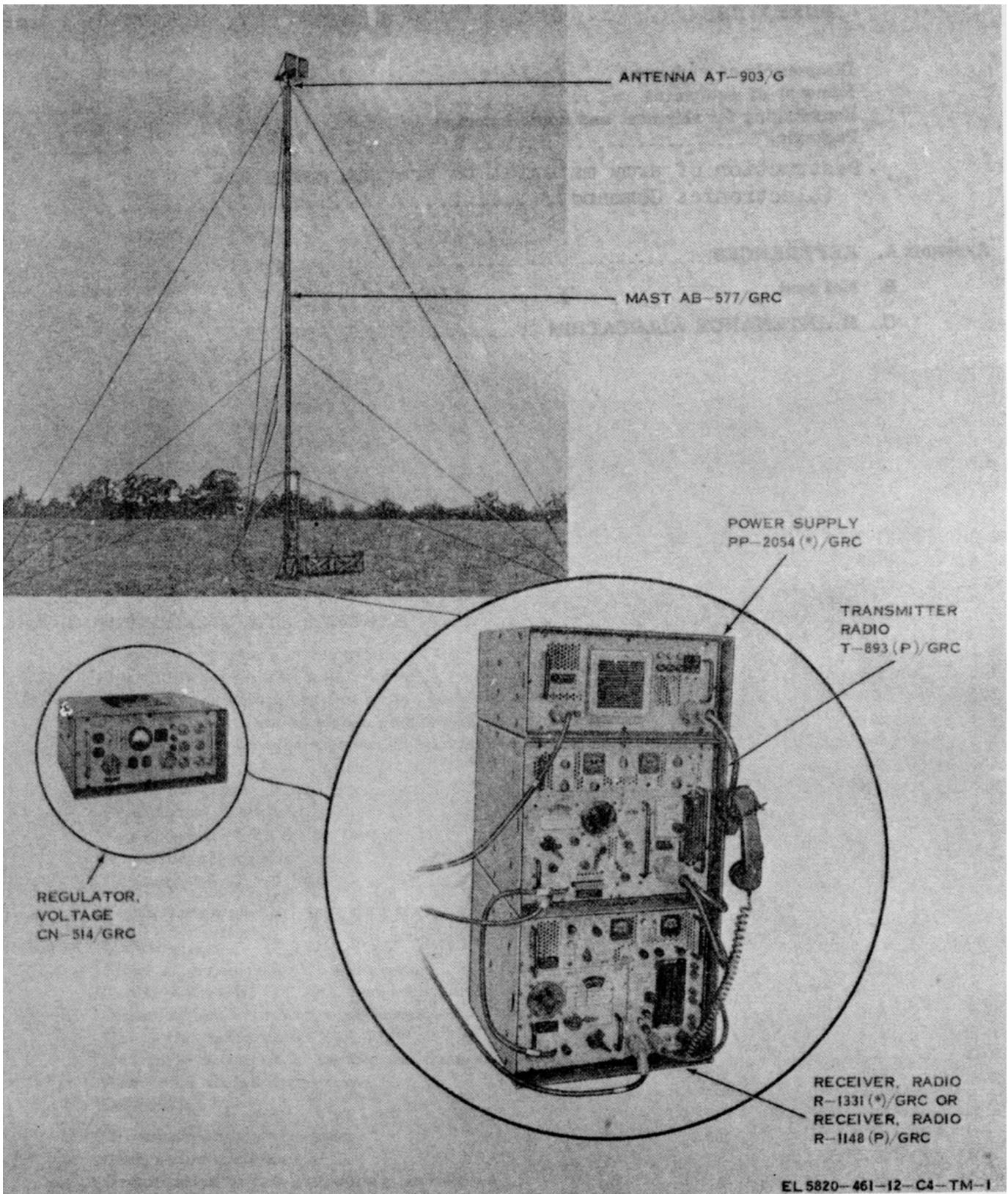

Figure 1-1. Radio Set AN/GRC-50(*) (v) IN operation.
iv Change 4

CHAPTER 1 INTRODUCTION

Section I. GENERAL

1-1. Scope

a. This manual describes Radio Sets AN/GRC-50(V) 1, 2, 3, 4, and 5 and AN/GRC-50A(V) 1, 2,3,4, 5, 6, 7, 8, 9, 10, and 11. It covers their installation, operation, and operator's and organizational maintenance. The components of the radio sets are listed in paragraph 1-6.

b. and maintenance of Mast AB-577/GRC (figs. 1-1 and 1-8) are provided in TM 11-5820-538-12 which also includes information on the use of Extension Kit MK-806/GRC which is used to extend the height of the antenna to another 25 feet above the 50-foot height of the AB-577/GRC.

c. Organizational maintenance of Voltage Regulator CN-514/GRC is provided in TM 11-6110-245-15.

d. Official nomenclature followed by (*) is used to indicate all models of the equipment item. Thus-

(1) Radio Set AN/GRC-50()/V applies to all configurations of the radio set: AN/GRC-50(V) 1, 2, 3, 4, and 5 and AN/GRC-50A(V)1, 2, 3, 4, 5, 6, 7, 8,9, 10, and 11.

(2) Amplifier-Converter AM-1955()/GRC applies to Amplifier-Converters AM-1955/GRC, AM-1955A/GRC, and AM-1955B/GRC (pare 1-14d).

(3) Amplifier-Converter AM-1956()/GRC applies to Amplifier-Converters AM-1956/GRC, AM-1956A/GRC, and AM-1956B/GRC (pare 1-14d).

(4) Amplifier-Oscillator AM-1958()/GRC applies to Amplifier-Oscillators AM-1958/GRC and AM-1958A/GRC (para 1-14e).

e. Throughout this manual, the term radio set applies to all configurations of the AN/GRC-50(~)(V), unless otherwise specified.

f. All references in this manual to Receiver, Radio R-1331 (*)/GRC also apply to Receiver, Radio R-1331 (P)/GRC, Receivers, Radio R-1331A(P)/GRC, and R-1331B(P)/GRC unless otherwise specified (pare 1-14b and c).

g. All references in this manual to Power Supply PP-2054(*)/GRC also apply to Power Supply PP-2054/GRC and to Power Supply PP-2054A/GRC (pare 1-14g).

1-2. Indexes of Equipment Publications

a. *DA Pam 310-4.* Refer to the latest issue of DA Pam 310-4 to determine whether there are new editions, changes or additional publications pertaining to the equipment.

b. *DA Pam 310-7.* Refer to the latest issue of DA Pam 310-7 to determine whether there are modification work orders (MWO's) pertaining to the equipment.

1-3. Maintenance Forms, Records, and Reports

a. *Reports of Maintenance and Unsatisfactory Equipment.* Department of the Army forms and procedures used for equipment maintenance will be those described by TM 38-750, The Army Maintenance Management System.

b. *Report of Packaging and Handling Deficiencies.* Fill out and forward DO Form 6 (Packaging Improvement Report) as prescribed in AR 700-58/-NAVSUPINST 4030.29/AFR 71-13/MCO P4030.29A and DLAR 4145.8.

c. *Discrepancy in Shipment Report (DISREP) (SF 361).* Fill out and forward Discrepancy in Shipment Report (DISREP) (SF 361) as prescribed in AR 55-38/NAVSUPINST 4610.33B/AFR 75-18/MCO P4610.19C and DLAR 4500.15.

1-3.1. Reporting of Errors

Report of errors, omissions, and recommendations for improving this equipment manual by the individual user is encouraged. Reports should be submitted on DA Form 2028 (Recommended changes to Publications and Blank Forms) and forwarded direct to Commander, US Army Communications and Electronics Materiel Readiness Command, ATTN: DRSEL-MEMQ, Fort Monmouth, NJ 07703.

Section II. DESCRIPTION AND DATA

1-4. Purpose and Use

a. All configurations of the radio set provide for multichannel, line-of-sight, two-way communication in the ultrahigh-frequency (uhf) range. The radio sets provide 399 operating channels in-the 601.5- to 999.5-mega-cycle (mc) (low band) range and 500 channels in the 1,350.5- to 1,849.5-mc (high band) range. Some radio set configurations include both bands, others include either the high band or the low band. The differences between the model of the radio and the assemblages in which it is used are provided in paragraph 1-14a.

b. The radio set is intended primarily for use as a radio link in a communication network, which includes carrier telephone and teletypewriter equipment (para 1-14a). The radio sets are used in pairs; one set is used at each end of a line-of-sight transmission path. The radio set may be used with 4-, 12-, or 24-channel frequency-division multiplex (fdm) or 12- or 24-channel pulse-code modulation (pcm) equipment.

c. The radio set can also communicate with F-band (789.5 to 964.5 mc) and J-band (1,350.5 to 1,849.5 mc) configurations of Radio Set AN/TRC-24 (para 1-18). This arrangement applies to communication between fdm systems; there is no provision in the AN/TRC-24 for pcm operation.

1-5. Technical Characteristics

a. Radio Sets AN/GRC-50(*) (V).

Types of operation	Pcm, fdm, and local or remote order wire.
Fdm input levels (nominal):	
24-channel operation	13 dbm.
12-channel operation	11 dbm.
4-channel operation	6 dbm.
Fdm output levels (nominal):	
24-channel operation	13 dbm.
12-channel operation	11 dbm.
4-channel operation	6 dbm.
Fdm impedance:	
Input	136 or 600 ohms, balanced.
Output.....	135 or 600 ohms, balanced.
Fdm frequency response:	
135-ohm termination (12/24 channel)	250 cps to 4 kc, +1 db. 4 kc to 68 kc, +0.5 db. 68 kc to 124 kc, +1 db.
600-ohm termination (4 channel)	250 cps to 4 kc, +db. 4 kc to 20 kc, +0.5 db.
Pcm level (nominal):	
Input	1.5 volt peak to peak.
Output.....	0.75 volt peak to peak.
Pcm impedance (nominal):	
Input	50 ohms.
Output.....	50 ohms.
Range (approximate; range will vary according to atmos-	

pheric conditions and terrain):	
Pcm	30 miles or line-of-sight.
Fdm	30 miles or line-of-sight.
<i>b. Transmitter, Radio T -8 93(P)IGRC.</i>	
Frequency range.....	601.5 to 999.5 mc (with low band tuner, Amplifier-Oscillator AM-19571GRC). 1,350.5 to 1,849.5 mc (with high-band tuner, Amplifier-Oscillator AM-1958(*)/GRC).
Channel allocation:	
Low band.....	1-399 (601.5 to 999.5 mc).
High band.....	400~899 (1,350.5 to 1,849.5 mc).
Channel separation.....	1 mc.
Frequency stability.....	±0.005~o +90 kc of carrier frequency.
Type of modulation.....	Frequency modulation.
Type of transmission.....	Voice and either pulse-code modulation (pcm) or frequency-division multiplexed (fdm) signals.
Frequency control.....	Crystal-referenced automatic frequency control system
Frequency deviation	375 kc maximum.
RF output:	
Impedance	50 ohms.
Power:	
601.5 to 999.5 mc.....	15 to 30 watts.

TM 11-5820-461-12

1,350.5 to
1,849.5 mc 8 to 20 watts.
Spurious outputs Greater than 50 db down.
c. *Power Supply PP-2054(*)/GRC.*
Input 115 ±4 vac, 47 to 63 cps, 775
watts.

Outputs:
Regulated +250 +1 vdc at 200 mc.
+150 +8, 12 vdc at 80 ma.
+105 +6 vdc at 15 ma.
Unregulated +800 +25 vdc at 100 ma.
+650 +60 vdc at 60 ma.
+645 +60 vdc at 60 ma.
+360 +15 vdc at 80 ma.
115 +4 vac at 2.2
amperes.

d. *Receiver, Radio R-1 148(P)/GRC.*
Frequency range 601.5 to 999.5 me (channels
1-399, with low-band
tuner,
Amplifier- Converter AM-
1955(*)/GRC).
1,350.5 to 1,849 mc (channels
400-899, with high-band
tuner, Amplifier
Converter AM-1956(*)1
GRC).

Receiver type Double-conversion,
superheterodyne.
Type of modulation Frequency modulation.
Local oscillator
frequency 60 me below receiver
frequency.

Intermediate
frequencies:
First 60 me.
Second 17 me.
Frequency control Automatic frequency
control systems.
Primary: crystal
referenced.
Secondary: signal
seeking.

Spurious responses
(including image) ... Greater than 50 db down.
Rf input impedance... 50 ohms.
Power requirements:
Power supply Self-contained.
Power input 115 vac, ±5%, 47 to 63 cps,
315 watts.

e. *Receiver, Radio R-1881(*) (P)/GRC.* All technical
characteristics except frequency control, listed for the R-
1148(P)/GRC are applicable. Under Frequency control,
the Primary data does not apply to the
R-1331(*) (P)/GRC.

f. *Antenna AT-90S/G.*
Type Modified dipole in a ridge
loaded horn.
Operating frequency 600 me to 1,850 me.
Polarization Vertical or horizontal.
Weight 28 pounds.
Horizontal Polarization
Horizontal Beam Width
600 MHZ 45°
1850 MHZ 16°
Vertical Polarization
Horizontal Beam Width
600 MHZ 48°
1859 MHZ 20°
Gain (relative to isotropic radiator)
600 to 800 mc 11.0 db.
800 to 1,000 mc 13.0 db.
1,350 to 1,850 mc... 17.0 db.

g. *Mast AB-577/GRC.*
Type Sectionalized tubular.
Material Aluminum.
Height:
Maximum
expanded 48 feet.
Collapsed 95 inches.
Stability ±5% of original setting for
winds up to 75 mph,
under
conditions of 1/2-inch ice
loading.
Rotation Azimuth; rotation-controlled
from ground.

h. *Regulator, Voltage CN-514/GRC.*
Capacity 5 kva.
Efficiency Better than 98%.
Input:
Voltage 95 to 135 vac.
Frequency 47.5 to 63.5 cps.
Output:
Automatic
regulation 115 vac ± 1%.
Current 0 to 43 amperes.

1-6. Components of .AN/GRC-50(*) (V)

a. *Assemblages Using AN/GRC-50(*) (V).* Following is a list of the various configurations of the AN/GR-50(*) (V) and the assemblages in which they are used. The list of components of some assemblages do not identify the particular AN/GRC-50(*) (V) configuration used; instead they list the individual radio components provided in the assemblage. Refer to appendix A for the publications covering the assemblages listed.

TM 11-5820-461-12

<i>Radio configuration</i>	<i>No. of stacks</i>	<i>High or low band</i>	<i>Used in assemblage</i>
AN/GRC-50(V)1	1	High and low	Training
AN/GRC-50(V)2	2 (1 standby)	High	AN/MRC-73 & AN/MRC-102
AN/GRC-50(V)3	2 (1 standby)	Low	AN/MRC-73 & AN/MRC-102
AN/GRC-50(V)4	3 (1 standby)	High	AN/MRC-54 & AN/MRC-103
AN/GRC-50(V)5	3 (1 standby)	Low	AN/MRC-54 & AN/MRC-103
AN/GRC-50A(V)1	1	High and low	Training
AN/GRC-50A(V)2	2 (1 standby)	High	AN/MRC-102
AN/GRC-50A(V)3	2 (1 standby)	Low	AN/MRC-102
AN/GRC-50A(V)4	3 (1 standby)	High	AN/TRC-110
AN/GRC-50A(V)5	3 (1 standby)	Low	AN/TRC-110
AN/GRC-50A(V)6	2 (1 standby)	High and low a.....	AN/MRC-102, AN/TRC-109,& AN/TRC-117
AN/GRC-50A(V)7	3 (1 standby)	High and low a.....	AN/TRC110
AN/GRC-50A(V)8	1	High and low a.....	AN/TRC-108 and AN/TRC 143
AN/GRC-50A(V)9	1	High and low a.....	AN/TRC108
AN/GRC-50A(V)10	3 (1 standby)	High and low a.....	AN/TRC-110
AN/GRC-50A(V)11	1	High	A basic stack; less CN-514/ GRC, DA-189/GRC, CY-2582 (and spare heads), and CY- 2583/GRC (and spare parts).

★Either the high or low-band units of the amplifier oscillator and amplifier-converter are issued; the other units may be requisitioned if required.

b. Remarks.

(1) *Mast AB-577/GRC.* Refer to TM 11-5820-53~12 for a listing of the components of the mast.

(2) *Regulator, Voltage CN-514/GRC.* Refer to TM 114110-245-15 for a listing of the components of the voltage regulator.

(3) *Antenna AT-908/G.* Refer to TM 11-5820-517-12P for a listing of the components of the antenna. However, the carrying frame for the AT-903/G antenna horn is only issued for the training versions of the radio set: AN/GRC-50(V)1 and AN/GRC-50A(V)1.

(4) *Weights and dimensions.* Refer to paragraph 2-1b for information concerning the weights and dimensions of the major components.

c. Components. The numbers given in the Usable on code column in the following chart represent the radio configurations of which the item is a part. For example, 1 each Amplifier-Converter AM-1955/GRC is part of AN/GRC-50(V)1, 2 each are part of AN/GRC-50(V)3, and 3 each are part of AN/GRC-50(V)5. The following list identifies the radio configuration with the number used in the Usable on code column in the chart.

<i>Usable on code No.</i>	<i>Radio set</i>
1	AN/GRC-50(V)1
2	AN/GRC-50(V)2
3	AN/GRC-50(V)3
4	AN/GRC-50(V)4
5	AN/GRC-50(V)5
6	AN/GRC-50A(V)1
7	AN/GRC-50A(V)2
8	AN/GRC-50A(V)3
9	AN/GRC-50A(V)4
10	AN/GRC-50A(V)5
11	AN/GRC-50A(V)6
12	AN/GRC-50A(V)7
13	AN/GRC-50A(V)8
14	AN/GRC-50A(V)9
15	AN/GRC-50A(V)10
16	AN/GRC-50A(V)11

<i>Federal stock No.</i>	<i>Description</i>	<i>Usable on code</i>	<i>Qty (ea)</i>	<i>Figure No.</i>
5820-892-3851	Radio Set AN/GRC-50(V)1	1		
5820-892-3852	Radio Set AN/GRC-50(V)2	2		
5820-892-3852	Radio Set AN/G(V)3	3		
5820-892-3854	Radio Set AN/GRC-50(V)4	4		
5820-892-3855	Radio Set AN/GRC-50(V)5	5		
5820-933-6193	Radio Set AN/GRC-50A(V)1	6		
5820-933-6192	Radio Set AN/GRC-50(AV)2	7		

<i>Federal stock No.</i>	<i>Description</i>	<i>Usable on code</i>	<i>Qty (ea)</i>	<i>Figure No.</i>
5820-933-6191	Radio Set AN/GRC-60A(V)3	8		
5820-933-6190	Radio Set AN/GRC-60A(V)4	9		
5820-933-6189	Radio Set AN/GRC-60A(V)6	10		
5820-936-5480	Radio Set AN/GRC-50A(V)6	11		
5820-936-5481	Radio Set AN/GRC-50A(V)7	12		
5820-935-0089	Radio Set AN/GRC-50A(V)8	13		
5820-878-8636	Radio Set AN/GRC-60A(V)9	14		
5820-878-8634	Radio Set AN/GRC-50A(V)10	15		
5820-136-4966	Radio Set AN/GRC-50A(V)11	16		
	TM 11-5820-461-12	1 through 16	1	
5820-892-3859	Amplifier-Converter AM-1955/GRC	1	1	1-5
		3	2	
		5	3	
5820-082-4293	Amplifier-Converter AM-1955A/GRC, AM-1955B/GRC.	6,13,14	1	1-6
		8,11	2	
		10,12,15	3	
5820-892-3860	Amplifier-Converter AM-1956/GRC	1	1	1-13
		2	2	
		4	3	
5820-082-4294	Amplifier-Converter AM-1956A/GRC, AM-1956B/GRC	6,13,14,16	1	1-6
		7,11	2	
		9,12,15	3	
5820-892-3856	Amplifier-Oscillator AM-1957/GRC	1,6,13,14	1	1-4
		3,8,11	2	
		5,10,12,15	3	
5820-892-3857	Amplifier-Oscillator AM-1968, AM-1958A/GRC	1,6,13,14,16	1	1-4,1-3
		2,7,11	2	
		4,9,12,15	3	
5820-856-9925	Antenna AT-9031G (TM 11-5820-517-12P)	1,6,13,14,16	1	1-7
		2,3,7,8,11	2	
		4,5,9,10,12,15	3	
5820-064-5451	Case, Standardized Components, Electrical CY-2582/GRC (to store unused amplifier-converter and amplifier-oscillator).	1,6,13,14	1	1-31,1-13.1
		11		
		12,15		
5820-856-9923	Case, Antenna CY-2595/GR (issued only for AN/GRC-50(V)1, AN/GRC-50A(V)1, AN/TRA-25A, and OA-3668A/TRC-24) (carrying frame for AT-903/G).	1,6	1	
5820-892-3861	Dummy Load, Electrical DA-189/GRC	1,2,3,6,7,8,14,15	1	1-14
		11,13	1	
		4,5,9,10,12		
5820-892-3862	Mast AB-577/GRC (TM 11-5820-538-12)	1,6,13,14,16	1	1-8
		2,3,7,8,11	2	
		4,5,9,10,12,15	3	
5820-889-0857	Power Supply PP-2054(*)/GRC (incl Case, Electrical Components CY-2428/GRC: FSN 5820-064-5474).	1,6,13,14,15	1	1-4
		2,3,7,8,11	2	
		4,5,9,10,12,15	3	
5820-082-4292	Receiver, Radio R-1331(*)/GRC (incl Case, Electrical Components CY-2429/GRC; FSN 5820-064-5449).	6,13,16	1	1-6
		7,8,11	2	
		9,10,12,15	3	
5820-892-3858	Receiver, Radio R-1148(P)/GRC (incl Case, Electrical Components CY-2428/GRC; FSN 5820-064-5449).	1	1	1-5
		2,3	2	
		4,5	3	
6110-064-5478	Regulator, Voltage CN-514/GRC (TM 11-6110-245-15) (incl Case, Electrical Components CY-2851/GRC).	1,2,3,4,5,6,7,8,9,10	1	1-11
		11,12,13,14,15		
5930-064-5476	Switch Box SA-640/GRC	1,2,3,4,5	1	
5820-892-3863	Transmitter, Radio T-893(P)/GRC (incl Case,	1,6,13,14,16	1	1-4

Change 4 1-4.1

TM 11-5820-461-12

<i>Federal stock No.</i>	<i>Description</i>	<i>Usable on code</i>	<i>Qty (ea)</i>	<i>Figure No.</i>
	Electrical Components CY-2429/GRC: FSN 5820-064-5449).	2,3,7,8,11 4,5,9,10,12,15	2 3	
	<i>Cables and accessories</i>			
5935-972-5296	Adapter, Connector U-211/G	1,6,13,14,15 2,3,7,8,11	2 3	6-5
8105-497-9628	Bag BG-102A	4,5,9,10,12,15 1,6,8,13,14,16 2,3,7,11	5 1 2	1-2
5995-889-0852	Cable Assembly, Radio frequency CG-718B/u (3 ft.)	4,5,9,10,12,15 13,14,15	3 1	1-2
		1,6,11 12,15	2 3	
		2,3,7,8 4,5,9,10	4 8	
5995-889-0555	Cable Assembly. Special Purpose, Electrical CX-4557/GRC (3 ft).	1,6,13,14,16 2,3,7,8,11	1 2	1-2
		4,5,9,10,12,15	3	
5995-889-0999	Cable Assembly, Power, Electrical CX-10502/U (3 ft, 6 in).	11	1	
5995-930-9510	Cable Assembly, Power, Electrical CX-10503/U(4 ft).	13,16 12	2 6	
5995-889-0848	Cable Assembly, Power, Electrical CX-4558/U, 458/U, CX-4558A/U (3 ft. 6 in.).	1,6,13,14,16 2,3,7,8,11 4,5,9,10,12,15	1 2 3	1-2
5995-889-0849	Cable Assembly, Power, Electrical CX-4559/U (4 ft, 6 in.).	13,14, 1,2,3,4,5,6,7,8,9,10,11 12	1 2 3	1-2
		15	5	
5995-889-1079	Cable Assembly, Power, Electrical CX-4559/U (8 ft, 6 in.).	13,14 2,3,4,5,7,8,9,10,11 15	1 2 3	1-2
5965-892-3850	Handset H-156/U	1,6,13,14,16 2,3,7,8,11 4,5,9,10,12,15	1 2 3	1-2
5965064-5435	Holder, handset MT-2161/U	1,6,13,14,16 2,3,7,8,11 4,5,9,10,12,15	1 2 3	1-2
5995-134-5539	Reel-Cable Assembly includes:			
5820-064-5452	Reel, Cable RC-436/GRC	1,6,13,14,16 2,3,7,8,11 4,5,9,10,12,15	1 2 3	1-10
5935-064-5561	Adapter, Connector UG-1373/U	1,6,13,14,16 2,3,7,8,11 4,5,9,10,12,15	1 2 3	1-10.1
5935-892-8878	Adapter, Connector UG-1374/U	1,6,13,16 11,14 12 2,3,7,8 4,5,9,10,15	1 2 3 4 6	1-10.1
5935-064-5560	Adapter, Connector UG-1375/U	1,6,13,14,16 2,3,11 4,5,12,15	1 2 3	1-10.1
5995-926-8030	Cable Assembly, Radiofrequency CG-3358/U (6 ft) (used in lieu of CG-718/U (4 ft: FSN 5995-935-2606) and CG-718B/U (6 ft: FSN 5995-889-0853).	1,6,11,13,14,16 2,3,7,8,11 4,5,9,10,12,15	1 2 3	
5995-889-0854	Cable Assembly, Radiofrequency CG-1859/U (40 ft).	1,6,13,14,15 2,3,7,8,11 4,5,9,10,12,15	1 2 3	1-10

TM 11-5820-461-12

<i>Federal stock No.</i>	<i>Description</i>	<i>Usable on code</i>	<i>Qty (ea)</i>	<i>Figure No.</i>
5995-144-0244 4559-889-0527	Cable Assembly, Radiofrequency CG-1859A/U (40 ft). Cable Assembly, Radiofrequency CG-1859/U (80 ft).	1,6,12,14,16 2,3,7,8,11	1 2	1-10
	or	4,5,9,10,12,15	3	
4559-144-0245 5820-064-5450	Cable Assembly, Radiofrequency CG-1859A-U (80 ft). Case, Standardized Components, Electrical CY-2583/GRC	1,2,3,6,7,8,11,13,14 4,5,9,10,12,15	1 2	1-3,1-3.1
	(Following spare items are stowed in CY-2583/GRC)			
5820-892-9039	Arresstor, lighting	1,6,14 2,3,7,8,11,13 4,5,9,10,12,15	5 5 10	1-3,1-3.1
5960-262-3763	Electron tube: OB2WA	1,6,14 2,3,7,8,11,13 4,5,9,10,12,15	1 1 2	1-3,1-3.1
5960-884-1983	Electron tube: 4037A	15 1,6,14 2,3,7,8,11,13 4,5,9,10,12	24 4 4 8	1-3,1-3.1
5960-815-0813	Electron tube: 7289	1,6,2,3,7,8,11,13 14 15 4,5,9,10,12	3 2 4 8	1-3,1-3.1
5960-262-1357	Electron tube: 5654/6AK5W	1,6,14 2,3,7,8,11,13 4,5,9,10,12,15	2 2 4	1-3,1-3.1
5960-188-6584	Electron tube: 5670	1,6 2,3,7,8,11,13 4,5,9,10,12 15	4 4 8 10	1-3,1-3.1
5960-577-3078	Electron tube: 5687WA	1,6,14 2,3,7,8,11,13 4,5,9,10,12,15	1 1 2	1-3,1-3.1
5960-237-6917	Electron tube: 5725/6AS6W	1,6,14 2,3,7,8,11,13 4,5,9,10,12,15	1 1 2	1-3,1-3.1
5960-193-5145	Electron tube: 5751WA	1,6,14 2,3,7,8,11,13 4,5,9,10,12,15	2 2 4	1-3,1-3.1
5960-247-8748	Electron tube: 5842	1,6,14 2,3,7,8,11,13 4,5,9,10,12,15	1 1 2	1-3,1-3.1
5960-217-0361	Electron tube: 6AH6WA	1,6,14 2,3,7,8,11,13 4,5,9,10,12,15	1 1 2	1-3,1-3.1
5960-543-0219	Electron tube: 6AN5WA	1,6,14 2,3,7,8,11,13 4,5,9,10,12,15	1 1 2	1-3,1-3.1
5960-542-7182	Electron tube: 6080WB	1,6,14 2,3,7,8,11,13 4,5,9,10,12,15	2 2 4	1-3,1-3.1
5960-808-4212	Electron tube: 6146	1,6,14 2,3,7,8,11,13 4,5,9,10,12,15	1 1 2	1-3,1-3.1

TM 11-5820-461-12

<i>Federal stock No.</i>	<i>Description</i>	<i>Usable on code</i>	<i>Qty (ea)</i>	<i>Figure No.</i>
5960-820-8717	Electron tube: 6688	1,6,14 2,3,7,8,11,13 4,5,9,10,12,15	2 2 4	1-3,1-3.1
5960-262-0167	Electron tube: 12AT7WA	1,6,14 2,3,7,8,11,13 4,5,9,10,12,15	1 1 2	1-3,1-3.1
5920-131-9821	Fuse, cartridge F02B125V3A	1,6,14 2,3,7,8,11,13 4,5,9,10,12,15	5 5 10	1-3,1-3.1
5920-518-1743	Fuse, cartridge F02B125V3A5	1,6,14 2,3,7,8,11,13 4,5,9,10,12,15	5 5 10	1-3.1
5920-851-9476	Fuse, cartridge F02B125V5A	1,6,14 2,3,7,8,11,13 4,5,9,10,12,15	5 5 10	1-3,1-3.1
6240-155-7836	Lamp, incandescent (28v): MS25237-327	1,6,14 2,3,7,8,11,13 4,5,9,10,12,15	1 1 2	1-3,1-3.1
6240-155-7857	Lamp, incandescent (6v): MS25237-328	1,6,14 2,3,7,8,11,13 4,5,9,10,12,15	3 3 6	1-3,1-3.1
5960-224-4868	Semiconductor device, diode 1N21B	1,6,14 2,3,7,8,11,13 4,5,9,10,12,15	2 2 4	1-3
5960-262-0315	Semiconductor device, diode 1N21C	1,6,14 2,3,7,8,11,13 4,5,9,10,12,15	2 2 4	1-3
5960-645-4309	Semiconductor device, diode 1N23WE	1,6 2,3,7,8,11,13 4,5,9,10,12,15	2 2 4	1-3
5960-615-5550	Semiconductor device, diode 1N21WE	1,6,14 2,3,7,8,11,13 4,5,9,10,12,15	1 1 2	1-3
5120-293-0808	Tube Puller TL--201	1,6 2,3,7,8,11,13 4,5,9,10,12,15	1 1 2	1-3,1-3.1
5120-293-2696	Tube puller, 7-pin	1,6,14 2,3,7,8,11,13 4,5,9,10,12,15	1 1 2	1-3,1-3.1
5120-293-2693	Tube puller, 9-pin	1,6,14 2,3,7,8,11,13 4,5,9,10,12,15	1 1 2	1-3,1-3.1
5120-788-1623	Tool, extracting	1,6,14,15 2,3,7,8,11,13 4,5,9,10,12	1 1 2	1-3.1
(Following items are accessories)				
6625-889-1583	Test lead	1,2,3,4,5,6,7,8,9,10	1	1-2
6625-965-0498	Test lead	1,2,3,4,5,6,7,8,9,10	1	1-2
5120-224-2596	Wrench, socket: 5/16 in.	1,11,12,13,14,15 2,3 4,5	1 2 3	1-2
5120-222-8858	Screwdriver, 4 in. blade	14,15	1	
	Screwdriver, 3 in. Blade	14,15	1	
7510-889-3494	Log Book Binder	14,15,16	1	
(Following spare items are stowed in CN-514/GRC)				
5960-284-9285	Electron tube: 5727/2D21W	1 through 15	1	5-11
5920-665-2881	Fuse, cartridge: F03A250V1A	1 through 15	1	5-11

<i>Federal stock No.</i>	<i>Description</i>	<i>Usable on code</i>	<i>Qty (ea)</i>	<i>Figure No.</i>
5920-557-6057	Fuse, cartridge: F03A125V20A	1 through 15	1	5-11
6110-064-5369	Regulator assembly	1 through 15	1	5-11

1This list is the latest authorized revision and takes precedence over quantities shown in the figures.

2The excess are stored in the shelter.

3Compartments in figure 1-3 and 1-3.1 are shown filled with parts. However, some authorized quantities are less than compartments available.

1-7. Description of Radio Set

The major components of the radio set are installed in ruggedized cases that are used for carrying and stack mounting. All operating controls; meters; and power, antenna, and input and output connections are on the front panels of the various units. Paragraphs 1-8 through 1-12 describe the components of the radio set. The combination of Transmitter, Radio T-893(P)/GRC, Power Supply PP-2054(*)/GRC, and Amplifier-Oscillator AM-1957/GRC (or AM-1958(*)/GRC) comprises the transmitting equipment of the radio set. The combination of Receiver, Radio R-1148(P)/GRC with Amplifier-Converter AM-1955/GRC (or AM-1956/GRC) or Receiver, Radio R-1331(*)/GRC with Amplifier-Converter AM-1955A or B/GRC, (or AM-1956A or B/GRC) comprises the receiving equipment of the radio set. Antenna AT-903/G, a directional, horn-type antenna, is for both transmitting and receiving radiofrequency (RF) energy.

1-8. Transmitting Equipment

a. The transmitter portion of the radio set is illustrated in figure 1-4. Nylon slides on the inside of each equipment case permit the components to slide easily in and out of the cases. Transmitter, Radio T-893(P)/GRC contains a square opening in the lower left side for the installation of Amplifier-Oscillator AM-1957/GRC or Amplifier-Oscillator AM-1958(*)/GRC.

The equipment is air-cooled by a blower in the

T-893(P)/GRC. Air is received through an in take filter mounted on the inside of the T-893(P)/GRC front panel and is exhausted through an opening in the AM-1957/GRC (or AM-1958(*)/GRC).

b. Both the AM-1957/GRC and AM-1958(*)/GRC contain duplexers which permit transmission and reception from one antenna. When not in use, the AM-1957/GRC or AM-1958(*)/GRC is stored in Case, Standardized Components, Electrical CY2582/GRC (fig. 1-13).

c. Power Supply PP-2054(*)/GRC is stacked on top of the T-893(P)/GRC and provides operating potentials for the T-893(P)/GRC. A cooling fan and air filter are located at the front center of the chassis. Output voltage test jacks are accessible when the power supply is pulled out of the case.

1-9. Receiving Equipment

a. The receiving equipment on the radio set consists of the items illustrated in figures 1-5 and 1-6. Nylon slides on the inside of the case permit the components to slide easily in and out of the case. Receiver, Radio R-1148(P)/GRC or R-1331(*)/GRC contains a square opening in the lower left side for the installation of the low-band tuning unit (Amplifier-Converter AM-1955(*)/GRC), or the high-band tuning unit (Amplifier Converter AM-1956(*)/GRC). When not in use, the AM-1955(*)/GRC or AM-1956(*)/GRC is stored

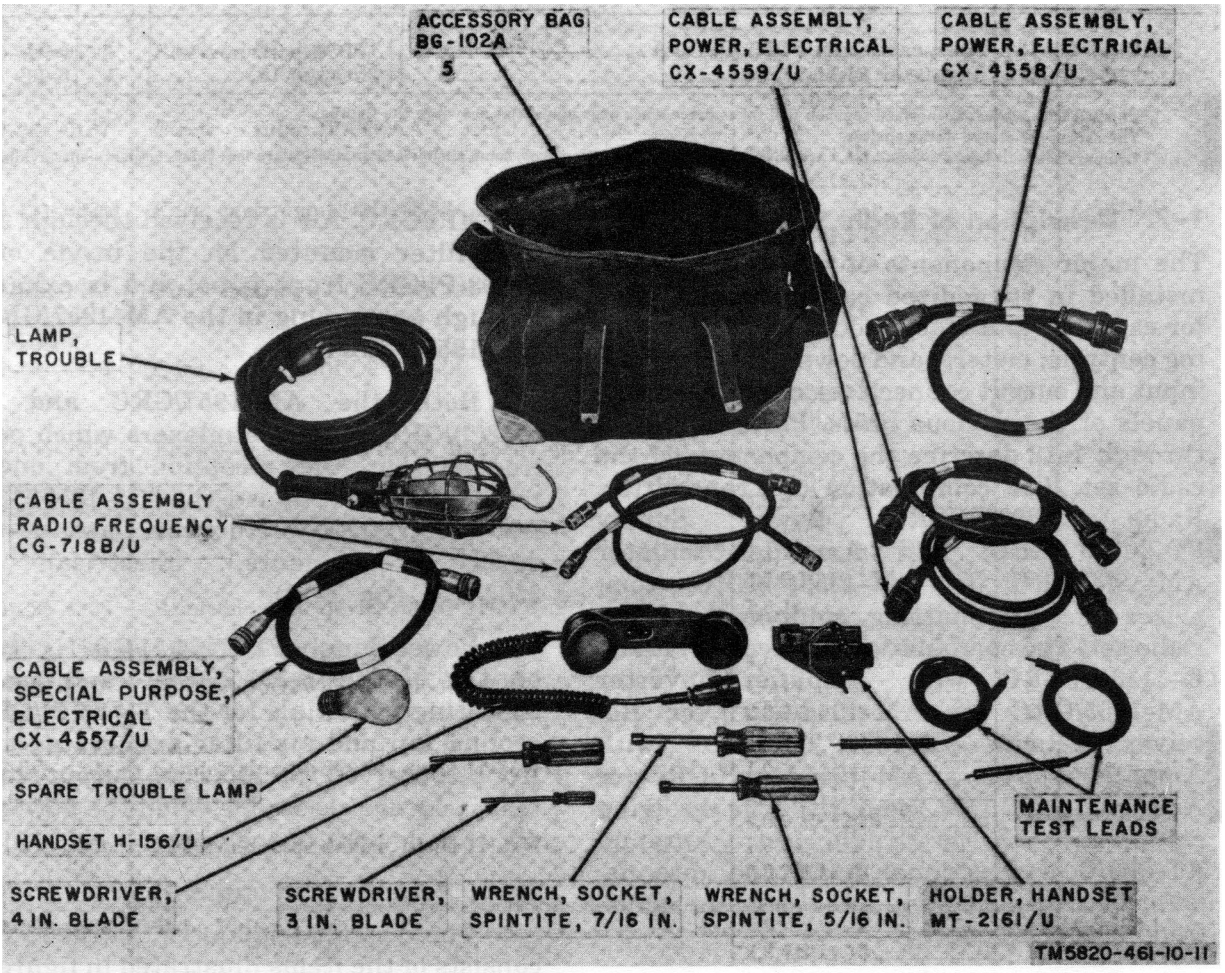

Figure 1-2. Accessory Bag BG-102A, with contents.

in Case, Standardized Components, Electrical CY-2582/GRC. The original designed case is shown in figure 1-3; the later designed case is shown in figure 1-3.1. The authorized spare items to be stowed in the case are given in para 1-6.

b. Operational controls, power connections, a handset connector for local order wire, a remote order-wire connector for field telephone, and connectors for the multiplex equipment are located on the front panels of the R-1148 (P)/GRC or R-1331(*) (P)/GRC (receiver), AM-1955(*)/GRC, and AM-1956(*)/GRC. An air intake and filter are on the right side of the front panel of the receiver. The air is pulled in by a blower, circulated, and exhausted through vents around the frame con. trots.

The power for the receiving equipment provided by a self-contained power supply (not shown) located on the lower rear deck of the receiver.

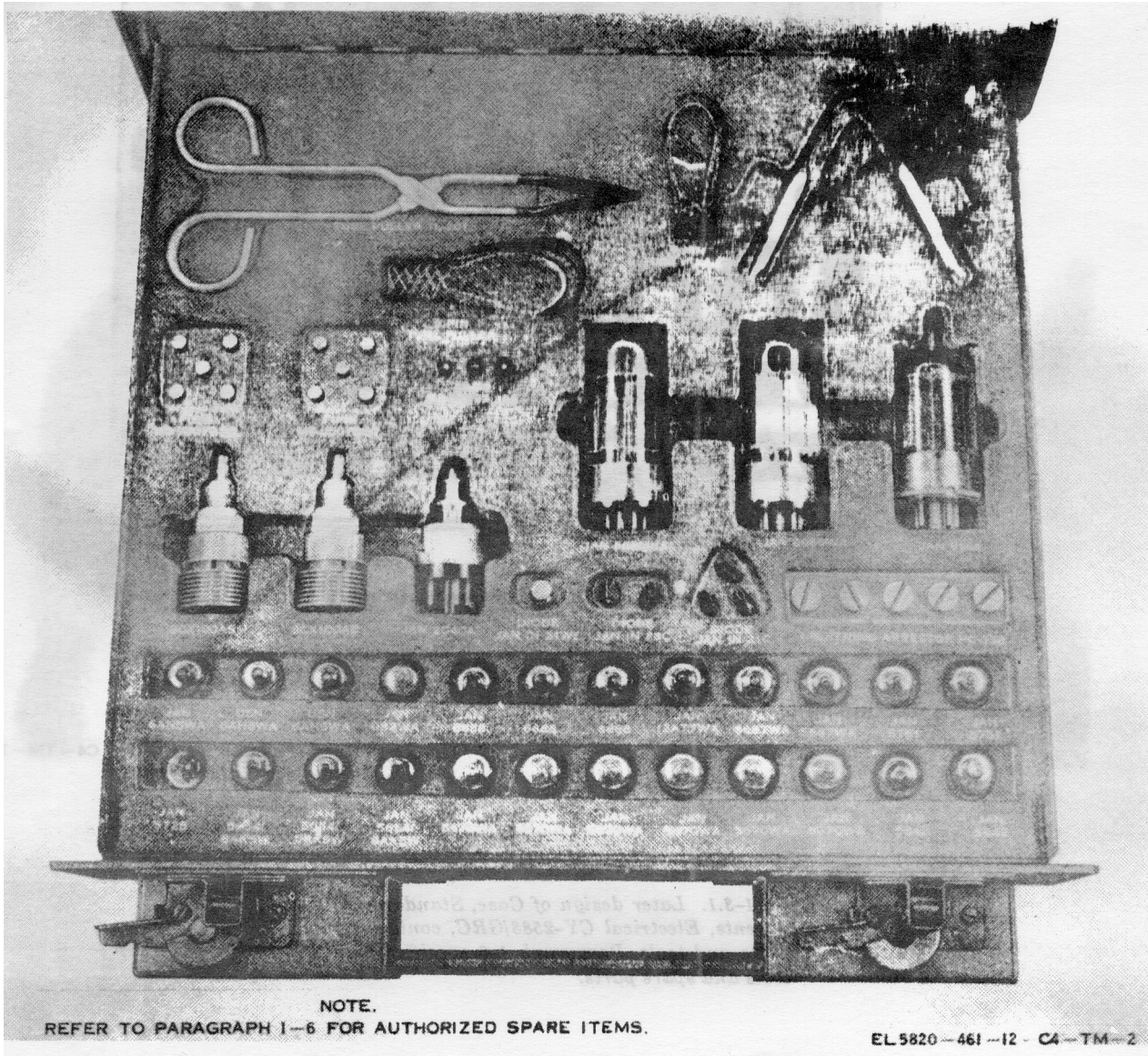

Figure 1-3. Original design of Case, Standardized Components, Electrical CY-2583/GRC, containing spare parts and tools. Paragraph 1-6 specifies authorized tools and spare parts.

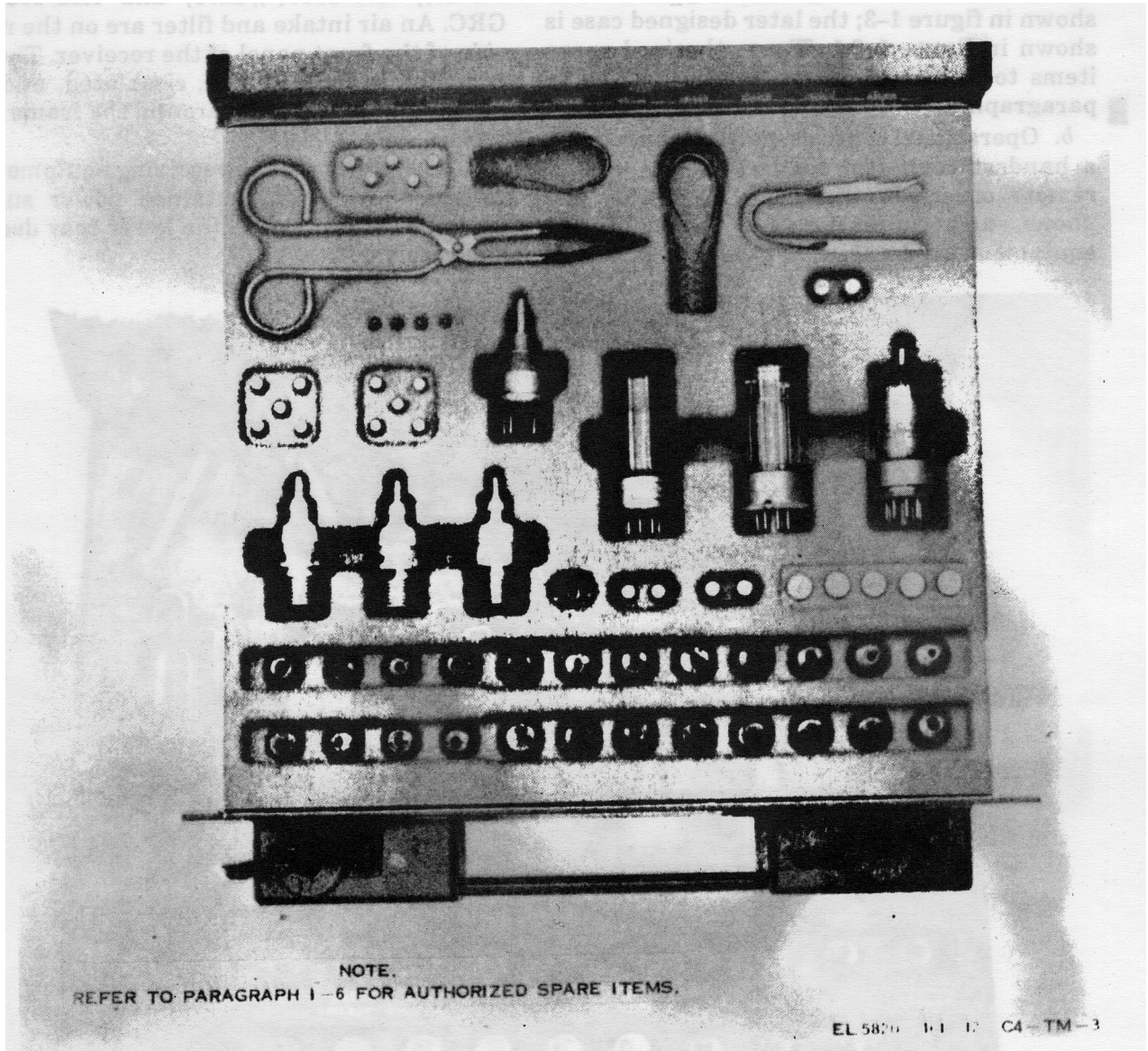

Figure 1-3.1. Later design of Case, Standardized Components, Electrical CY-2583/GRC, containing spare parts and tools. Paragraph 1-6 specifies authorized tools and spare parts.

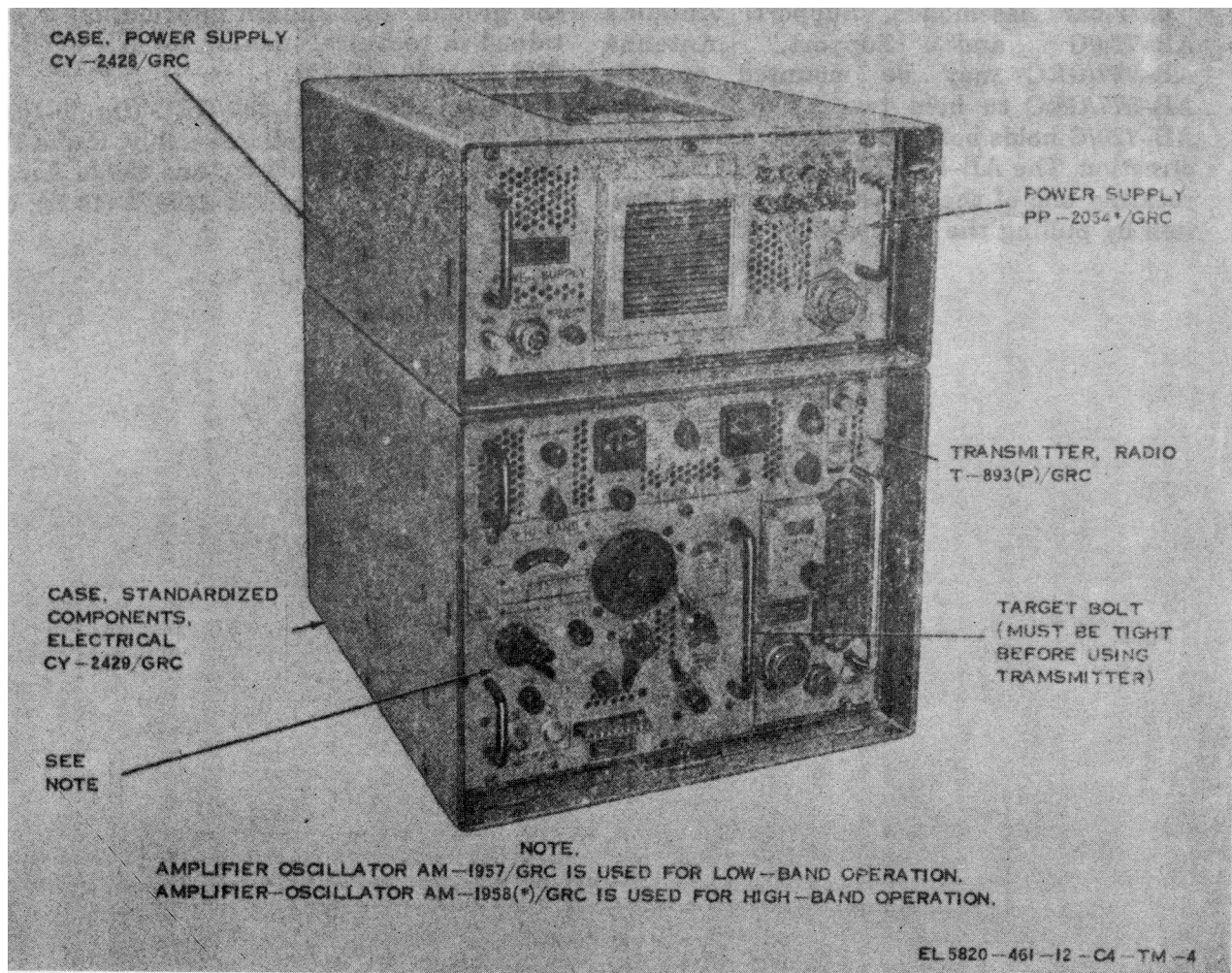

Figure 1-4. Transmitting equipment, major components.

1-10. Antenna Components

a. Antenna AT-903/G (fig. 1-7) is a directional antenna that consists of a modified dipole probe mounted in a ridge-loaded horn that can be positioned for either vertical or horizontal polarization. It has a broad frequency response and is capable of operation throughout the entire frequency range without adjustment. Antenna AT-903/G is installed on top of Mast Extension Kit MK-8061GRC and Mast AB-577/GRC. Connections to the receiver and transmitter are made through a coaxial cable to the front panel connector on the transmitter. Some AT-903/G's are provided with an arrow painted on the narrow end to indicate the antenna polarity with respect to ground.

b. Mast AB-577/GRC (fig. 1-8) (TM 11-5820-538-12) consists of eight tubular sections contained in a mast section carrier and a launcher device. When assembled, the mast provides a 48-foot mounting for Antenna AT-903/G.

c. Extension Kit, Mast MK-06/GRC (fig. 1-9) (TM 11-5820-538-12) consists of five tubular sections (contained in a mast section carrier case), cable assembly, and accessories (contained in accessory bag). When assembled with the AB-577/GRC, it raises the height of the antenna system to 75 feet. It is used with but is not part of the AN/GRC-50(*) (V).

TM 11-5820-461-12

d. T-bar assemblies, Support, Antenna AB-720/G and Support, Antenna AB-957/GRC may be mounted on the AB-577/GRC to hold two AT-9031G's. The AB-7201G holds both AT-903/G's in the same direction. The AB-957/GRC has provision for rotating one of the AT-9031G's in any direction by pulling the horn with lanyards from the ground. Installation information is contained in technical manual for AB-5771GRC (TM 11-820 538-12~).

e. Reel, Cable RC - 36/GRC (fig. 1-10) is used to store one Cable Assembly, Radio Frequency CG-1859/U (80 lb); one Cable Assembly, Radio Frequency CG-1859/U ~0 lb); one Cable As

Radio Frequency CG-718B/U (6 ft); two Adapters, Connector UG-1374/U; and one Adapter, Connector UG-1373/U. The RC-4 36/GRC is 32 inches in diameter and 12 inches in depth.

1-11. Regulator, Voltage CN-514/GRC

Regulator, Voltage CN-514/GRC (fig. 1-11) regulates and distributes the primary power source for the radio set. All controls and connections are

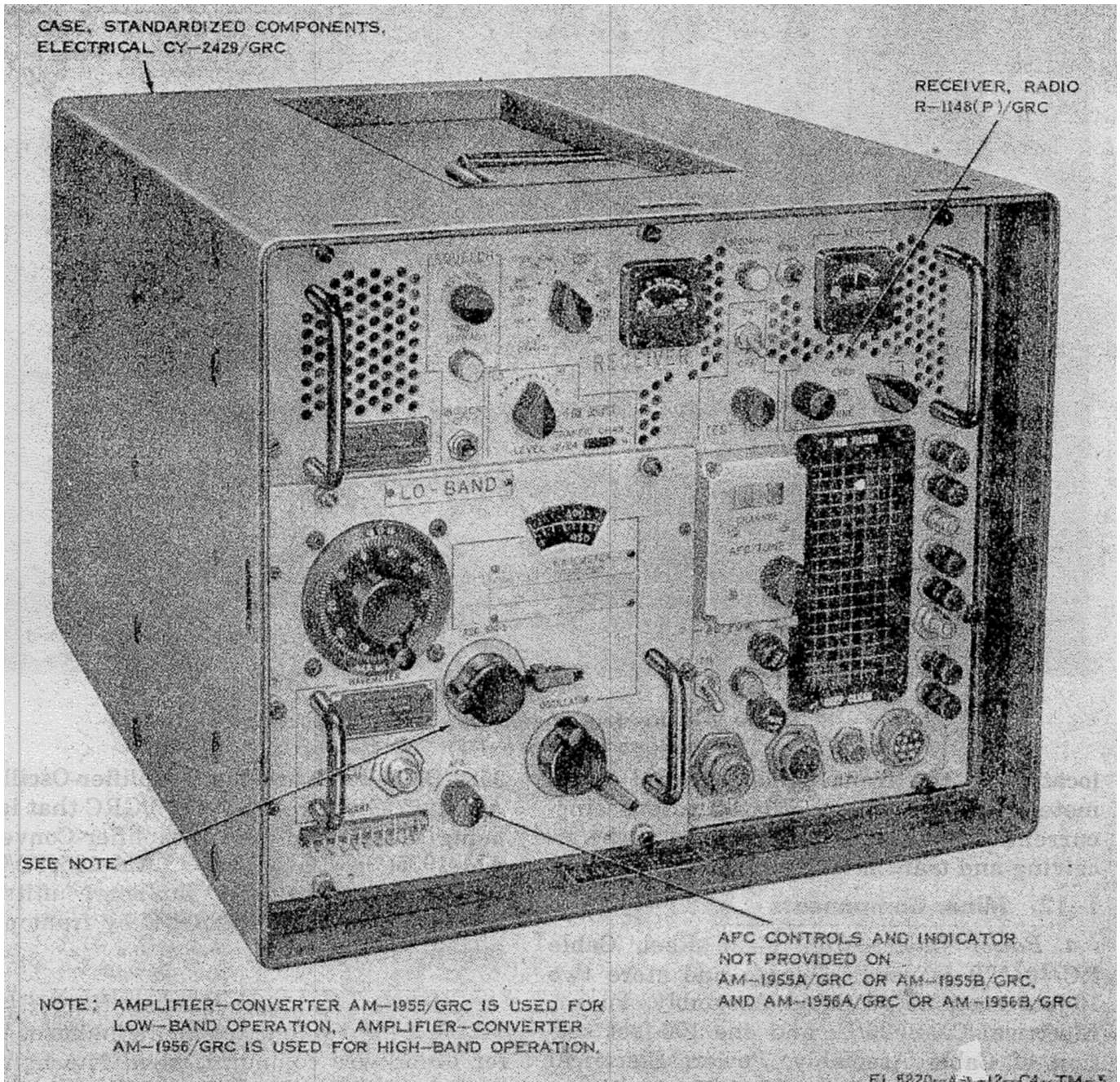

Figure 1-5. Receiving equipment, major components with Receiver, Radio R-1148(P)/GRC.

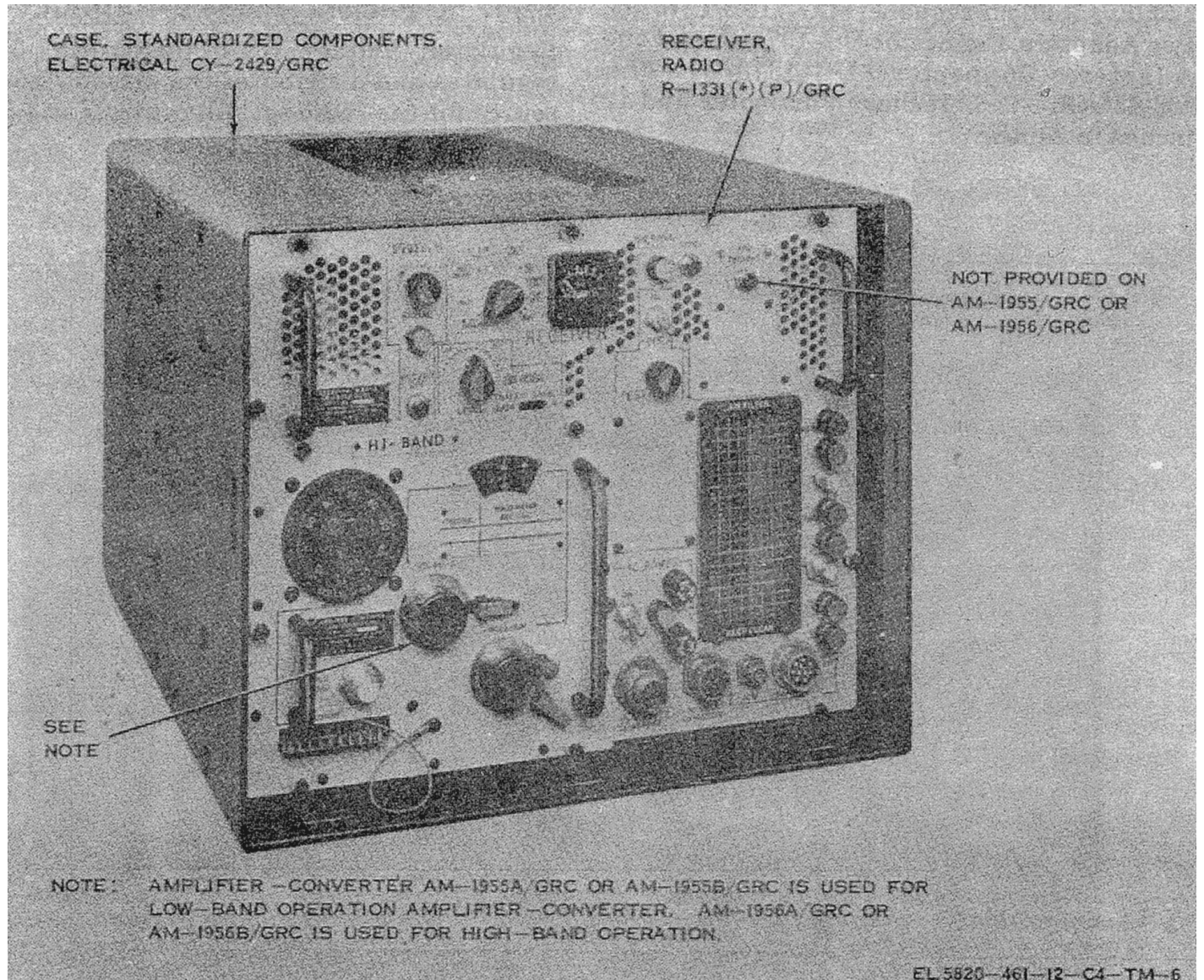

Figure 1-5. Receiving equipment, major components with Receiver, Radio R-1331(*) (P)/GRC.

located on the front panel. A front panel meter indicates the regulated alternating current (ac) output voltage applied to the receiving and transmitting equipments.

1-12. Minor Components

a. *Power Cables* (fig. 1-12). Reel, Cable RC 404/TR is used to carry and store two 10-foot sections of Cable Assembly, Power, Electrical CX-4686/U; and one 100-foot section of Cable Assembly, Power, Electrical CX-4668/U. The RC-404/TR is 24 inches in diameter and 6 inches in depth.

b. *Case, Standardized Components, Electrical CY-2582/GRC* (fig. 1-13). Case, Standardized Components, Electrical CY2582/GRC contains the Amplifier-Oscillator AM-1957/GRC or AM-1958(*)/GRG that is not being used, and the Amplifier-Converter AM-1955(*)/GRC or AM-1956(*)/GRC that is not being used. The spare units are secured in the CY-2582/GRC by front panel fasteners.

c. *Handset H-156/U*. Handset H-156/U (fig. 1-2) is a lightweight telephone handset used for order-wire communication. The handset cord terminates in a connector which attaches to the HANDSET connector on the front panel of the R-1148(P)/GRC or R-1331(P)/GRC. A press-to-talk switch is provided on the side of the handset.

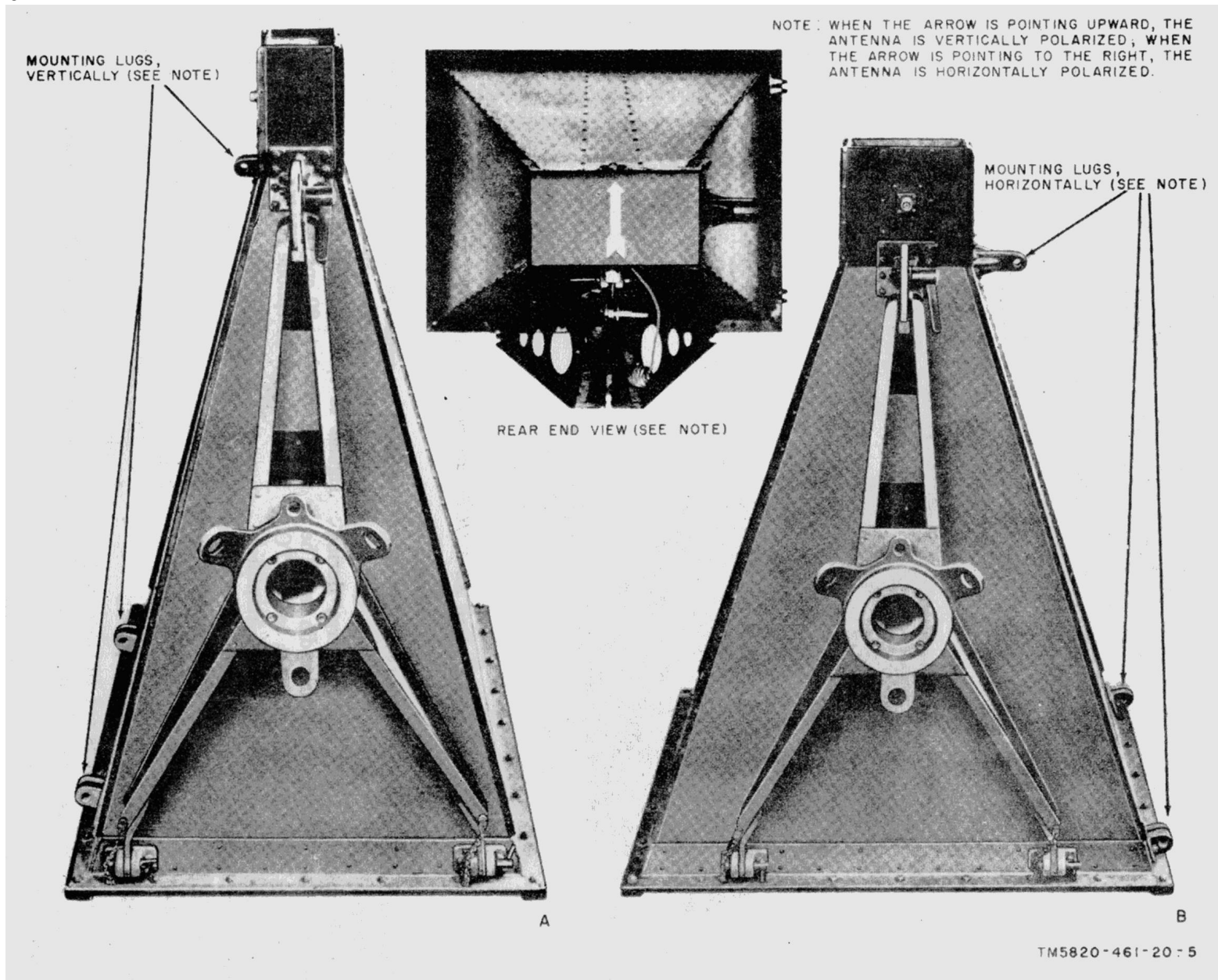

Figure 1-7. Antenna AT-903/G

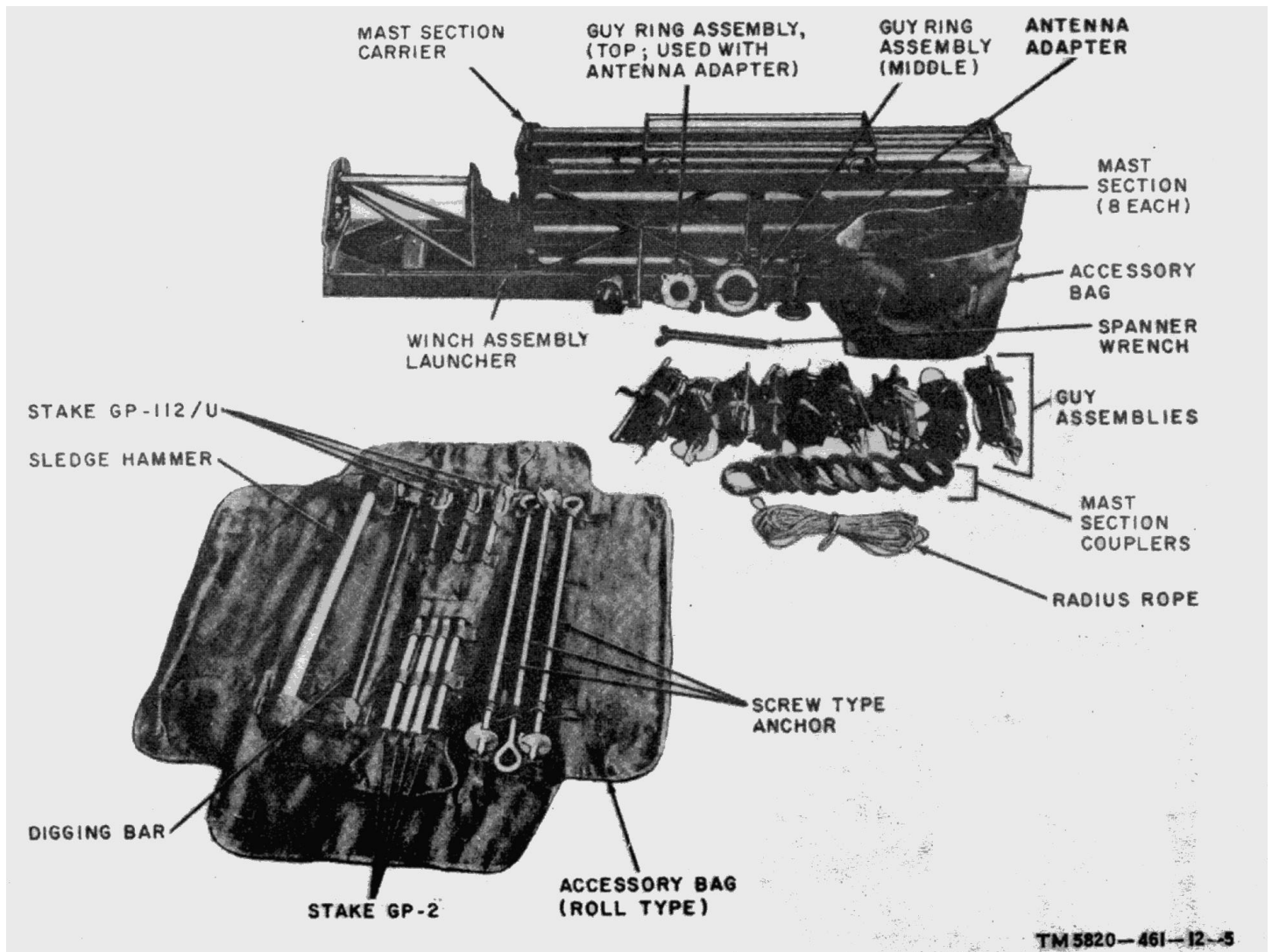

Figure 1-8. Mast AB 577/GRC and minor components.

d. *Dummy Load, Electrical DA-189/GRC* (fig. 1-14). Dummy Load, Electrical DA-189/GRC is used for dissipation of RF output energy during alignment and troubleshooting of the radio set. The cable from the DA-189/GRC attaches to the TO ANT connector on the front panel of Amplifier Oscillator AM-1957/GRC or AM-1958(*)/GRC. A meter included in the DA-189/GRC permits direct observation of the output power level.

1-13. Additional Equipment Required

The following equipment is not supplied as part of the radio set but is required for remote order wire operation.

a. *Telegraph-Telephone Signal Converter TA182/U*. The TA-182/U (TM 11-5805-247-12) is required for remote order-wire communication. It is used to convert 20-cycle-per-second (cps) ringing signals to 1,600-cps ringing signals, and 1,600-cps ringing signals to 20-cps ringing signals between the radio set and Telephone Set TA-312/PT.

b. *Telephone Set TA-312/PT*. Telephone Set TA-3312/PT (TM 11-2155) is required for remote order-wire communication. It is used to originate and receive order-wire signals from a remote location from the radio set to distances not exceeding 1 mile.

1-14. Differences in Models and Configurations

The major differences of the five different configurations of the radio set are in the operating

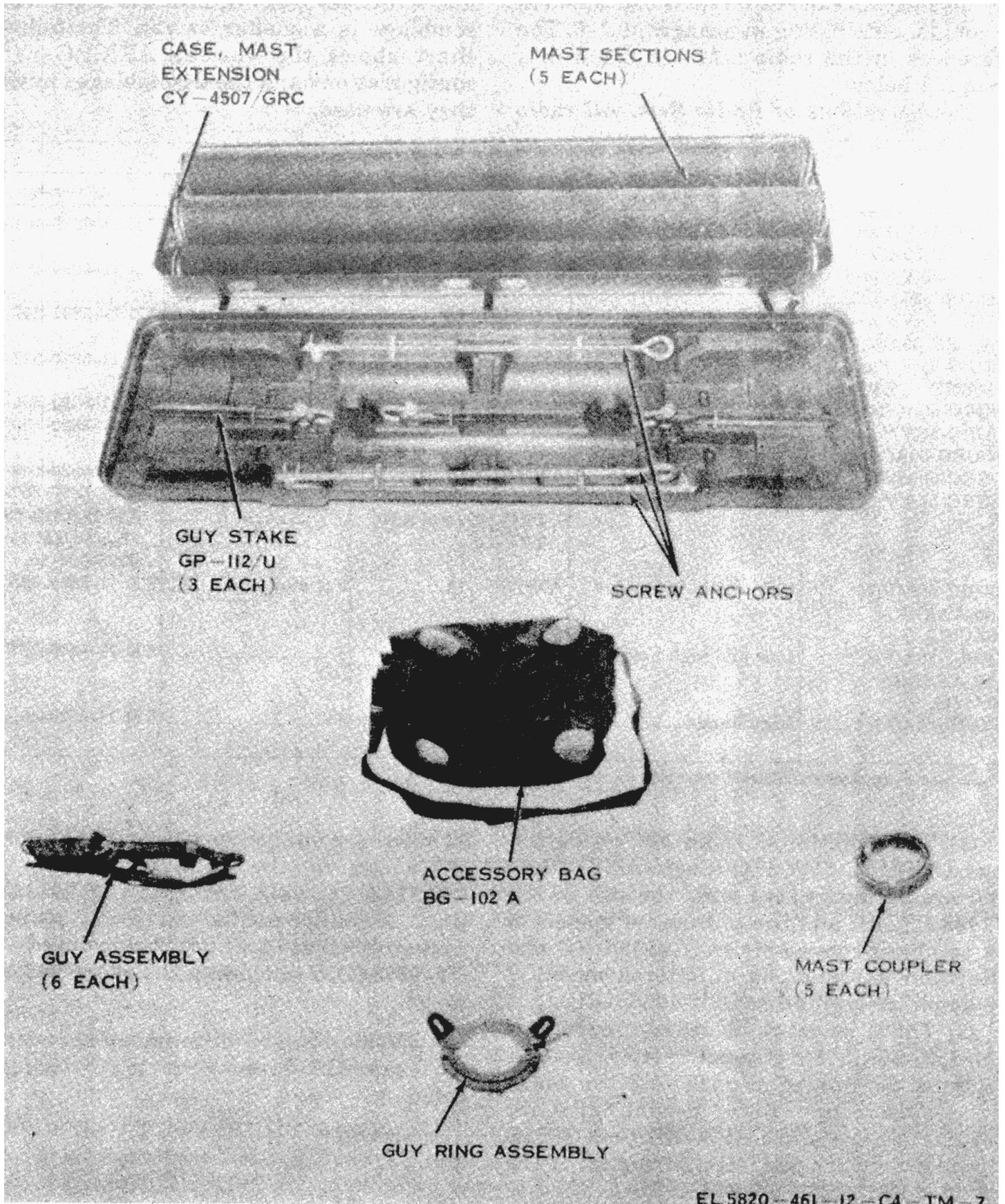

Figure 1-9. Extension Kit, Mast MK-806/GRC, components.

TM 11-5820-461-12

frequency. The detailed listing of the different items within each radio set is contained in the components listing in paragraph 1-5 The differences in the radio sets are listed in a through h below.

a. Configurations of Radio Sets. All radio set configurations, except AN/GRC-50(V)1 and AN/GRC-50A(V)1, are part of a radio assemblage in a shelter or van. The following chart shows the various AN/GRC-50(*) (V) configurations and the assemblages in which they are used.

<i>Radio Set</i>	<i>Low or High band</i>	<i>Assembly</i>	<i>Radio System Quantity of Stacks</i>	<i>Publications</i>
AN/GRC-50(V)1 and AN/GRC-50A(V)1	Low or high band-----	Training units	1-----	TM 11-5820-461-12
AN/GRC-50(V)2 and AN/GRC-50A(V)2.	High band-----	AN/MRC-102-----	2 (1 standby) -----	TM 11-5895-357-14
AN/GRC-50(V)3 and AN/GRC-50A(V)3.	Low band -----	AN/MRC-102-----	2 (1 standby) -----	TM 11-5895-357-14
AN/GRC-50(V)4 and AN/GRC-50A(V)4	High band-----	AN/MRC-103-----	3 (1 standby) -----	TM 11-5820-533-14
AN/GRC-50A(V)4	High band-----	AN/TRC-110 -----	3 (1 standby) -----	TM 11-5820-535-15
AN/GRC-50A(V)5 and AN/GRC-50A(V)5	Low band -----	AN/MRC-103-----	3 (1 standby) -----	TM 11-5820-533-14
AN/GRC-50A(V)5 -----	Low band -----	AN/TRC-110 -----	3 (1 standby) -----	TM 11-5820-535-15
AN/GRC-50(V)6 -----	Low and High band -----	AN/MRC-102, AN/ TRC-109, and AN/TRC-117	2 (1 standby) -----	TM 11-5820-357-14, TM 11-5820-536-15 ,and TM 11 5895-366-15
AN/GRC-50A(V)7 and AN/GRC-50A(V)10.	Low and high bands-----	AN/TRC-110 -----	3 (1 standby) -----	TM 11-5820-535-15
AN/GRC-50A(V)8 and AN/GRC-50A(V)9.	Low and high bands-----	AN/TRC-108 and AN/TRC-143.	1-----	TM 11-5895-367-15
AN/GRC-50A(V)11 -----	High band-----	Basic unit (see (3) below)	1-----	TM 11-5820-461-12

Low band or high band in assemblage. Other band may be requisitioned as required.

(1) The unlettered radio set configurations (AN/GRC-50(V)1 through AN/GRC-50 (V)5) are so designated with the use of the R-1148(P)/GRC and the unlettered models of the amplifier-converts (AM-1955/GRG and AM-19561GRC) and the unlettered model of the amplifier-oscillators (AM-1958/GRC).

(2) The A-model radio set configurations (AN/GRC-50A(V)1 through AN/GRC-50A (V)11) are designated as such with the use of all models of the R-1331(*) (P)/GRC (R-1331P/GRC, R-1331A(P)/GRC, or R-1331B (P)/GRC) and with the lettered models of the amplifier-converters (AM-1955A/GRC or AM-1955B/GRC, and AM-1956A/GRC or AM1956-B/GRC), and lettered model of the amplifier oscillator (AM-1 958A/GR C).

(3) The basic unit configuration AN/GRC-50A(V)11, is one stack, less those items whose quantities vary with the number of stacks in the configuration; namely, CN-514/GRC, DA-1891GRC, CY-2582/GRC (for amplifier-oscillator and amplifier converter that are not being used), and CY-2583/GRC (including the spare parts and tools).

b. *Receivers.* The differences between the various receivers are given in (1) through (4) below.

(1) The R-1331(P)/GRC, R-1331A(P)/GRC, and R-1331B(P)/GRC receivers do not have afc circuitry; the R-1148(P)/GRC has this circuitry.

(a) Externally, the R-1148(P)/GRC has an AFC TUNE control, an AFC LEVEL control, an-AFC SELECTOR switch, an AFC meter, and the multimeter switch has an AFC

LEV position; the other receivers do not have these items.

(b) The R-1148(P)/GRC does not have AFC DISABLE switch; the other receivers have this switch.

(c) Internally, the R-1148(P)/GRC has afc assembly 3A4; the other receivers do not have this assembly (fig. 6-6).

(2) Also internally, second intermediate frequency (IF) assembly 3A5, used in the R-1148(P)/GRC, differs electrically from the one used in the other receivers. The 3A5 assembly used with the R-1148(P)/GRC may not be used in the other receivers. The 3A5 assembly issued with the R-1331(*) (P)/GRC receivers can be used in the R-1148(P)/GRC. Each version of the 3A5 assembly has a different Federal stock number.

(3) In afc assembly 3A4 (used only in the R-1148(P)/GRC, and designated 2A4 when it is installed in T-893(P)/GRC (F(2) below), an insulator board is installed between terminal board E8 and the center partition (fig. 5-3.1) on equipment procured under order No. 64027-PP-63 and later procurements. If the insulation board is not provided, refer to paragraph 5-15d(3) for authorization and instructions for organizational maintenance facilities to install the insulator board.

c. *Receivers R-1331(P)/GRC, R-1331A-and R-1331B(P)/GRC.* These receivers differ from each other in the following respects:

(1) In R-1331(P)/GRC, the front panel AFC DISABLE switch has silver contacts; in the other receivers, the switch has gold contacts to give better performance.

(2) In second IF assembly 3A5, originally issued with R-1331A(P)/GRC and R-1331B(P)/GRC, resistor R79 is added in series with diode CR7 to improve a metering circuit. This resistor is not provided in 3A5's originally issued with R-1331(P)/GRC.

NOTE

The 3A5 assemblies originally issued with any of these receivers are mechanically and electrically interchangeable and may be used in any of the models of this receiver.

(3) Receiver R-1331B(P)/GRC is so identified because of the features described as follows for the two assemblies originally issued with this receiver:

(a) In receiver baseband assembly 3A3, a beaded sleeving is installed on the jumper wires that are connected between connector J3 and test jack J4 and between connector J2 and test jack J6.

(b) In second IF assembly 3A5, a resistor is added to provide on-scale receive signal metering indications.

d. *Amplifier-Converters.* The use and differences between the unlettered models (AM-1955/GRC and AM-1956/GRC) and lettered models (AM-1955A/GRC, AM-1955B/ GRC, AM-1956A/GRC, and AM-1956B/ GRC) are given in (1) through (5) below.

(1) The unlettered models of the amplifier-converters are used with the P-1148(P)/GRC; the lettered models are used with the other receivers (R-1331(P)/GRC, R-1331A(P)/GRC, and R-1331B(P)/GRC).

(2) The unlettered models of the amplifier-converters have automatic frequency control (afc) circuitry with the AFC correction control on the front panel (fig.1-5); the lettered models do not have the afc circuitry and the AFC control (fig. 1-6).

(3) Any model amplifier-converter may be used in any model of the receiver; however, for disabling the afc during tuning (para 3-8), the procedures are different when the lettered model amplifier-converter is used in the R-1148(P)/GRC.

(4) The B-model amplifier-converters differ from the A-model units in that filter capacitors C23 and C24 are provided in the filament circuit of tube V2 in first IF assembly 3A1A1/3A2A1 of the B-model unit.

(5) First IF assembly 3A1A1/3A2A1,, whether provided with the filter capacitors ((4) above) or not, are electrically and mechanically interchangeable and may be used in any model of any amplifier-converter.

e. *Amplifier-Oscillators* The uses and differences between the AM-1958/GRC and AM-1958A/GRC are given in (1) through (3) below.

(1) The AM-1958/GRC is used with the AN/GRC-50(V)1 through AN/GRC-50(V)5 configurations. The AM-1958A/GRC is used

TM 11-5820-461-12

with the AN/GRC-50A(V)1 through AN/ GRC-50A(V)11 configurations.

(2) The differences between the AM-1958/GRC (fig. 1-13) and AM-1958A/GRC (fig. 1-13.1) are in the mechanical connections between some front panel controls and the cavities inside the unit. Either model of the amplifier-oscillator can be used in the transmitter.

(3) The latest version of the AM-1958A/GRC includes a notch which is cut into the frame behind the spring cap for tube V3 (fig. 6-10). For those AM-1958A/GRC's that do not have the notch direct support maintenance facilities are authorized and required to cut the notch in the unit (para 15d(4)) and TM 11-5820 461-35).

f. Transmitter, Radio T-893(P)/GRC.

(1) In transmitters provided on order No. FR 36-039-N-6 31992(E) and on later procurements, a snap-on cover is provided for the bracket on which current regulator controls R14, R15, and R16 are mounted (fig. 5-12). Refer to paragraph 5-15d(2) for authorization and instructions for organizational maintenance facilities to install the snap-on cover.

(2) In afc assembly 2A4 (designated 3A4 when it is used in the R-1148(P)/GRC(b(3) above), an insulator board is installed between terminal board E8 and the center partition (fig. 5-3.1) on equipment procured under order No. 64027-PP-6 3 and later procurements. If the insulator board is not provided, refer to paragraph 5-15d(3) for authorization and instructions for organizational maintenance facilities to install the insulator board.

g. Power Supplies PP-2054/GRC and PP-2054A/GRC. The two power supplies differ from each other as follows:

(1) Capacitors C3, C4, C5, and C6 with associated bracket assemblies are different in both power supplies. The capacitors are the same value but are different types; the brackets are not interchangeable.

(2) In the PP-2054A/GRC, the HV fuse is 3 amperes, slo-blo, and the front panel is engraved with the marking 3AMP. In the PP-2054/GRC, the HV 6 AMP panel marking is changed by the using personnel and the 3-ampere, time-delay fuse is used. Refer to paragraph 5-15d(1) for authorization and instructions for organizational maintenance facilities to install the 3-ampere fuse.

h. Regulator, Voltage CN-514/GRC. On equipment procured on order No. FR 36-039-N-6-31992(E) and later procurements the following words are inscribed on the front panel: CAUTION: OUTPUT VOLTAGE SHALL NOT BE ADJUSTED TO EXCEED 115 VOLTS. This caution is not provided on earlier procurements of the regulator.

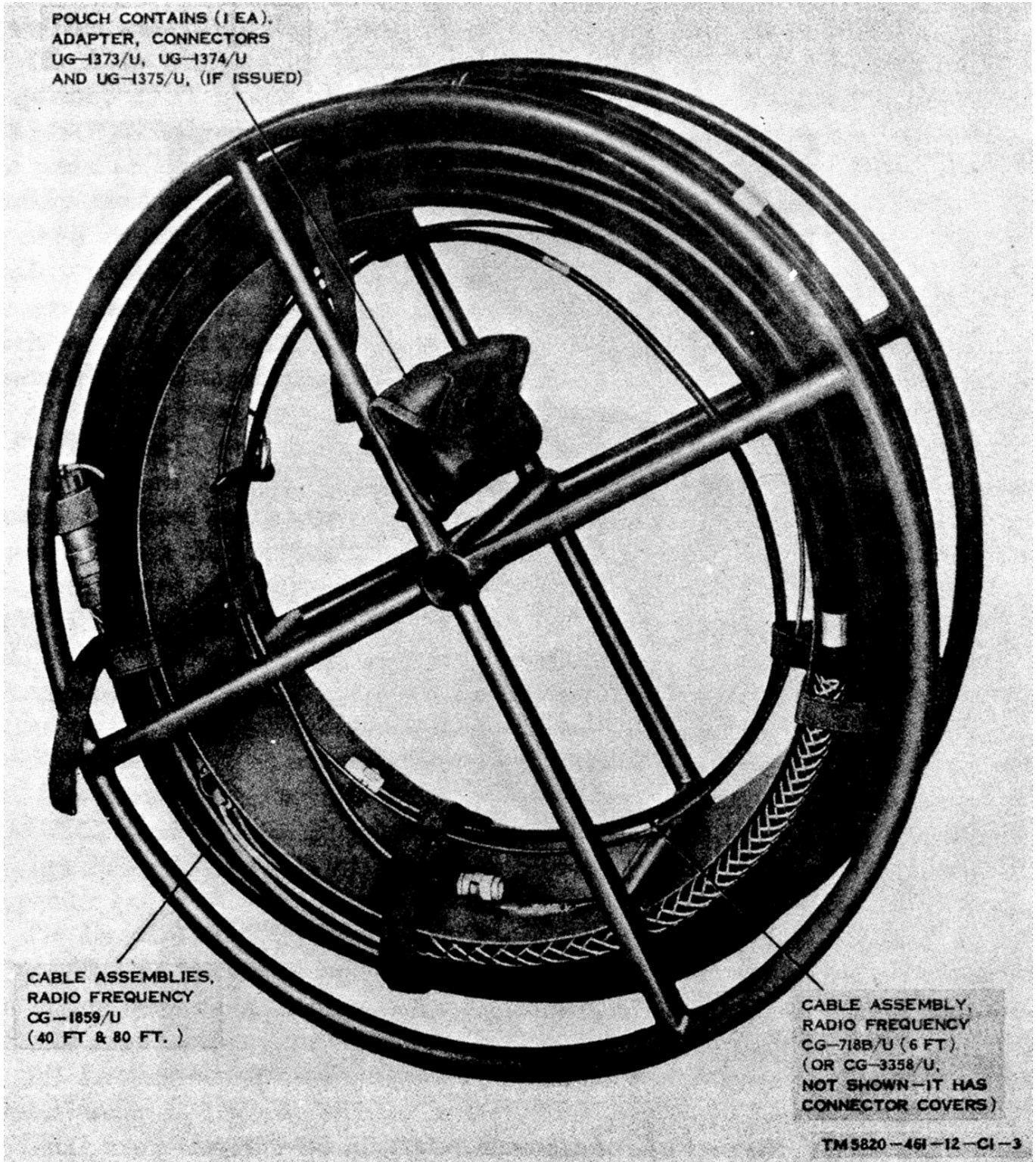

Figure 1-10. Reel, Cable RC-436/GRC, with components mounted on it.

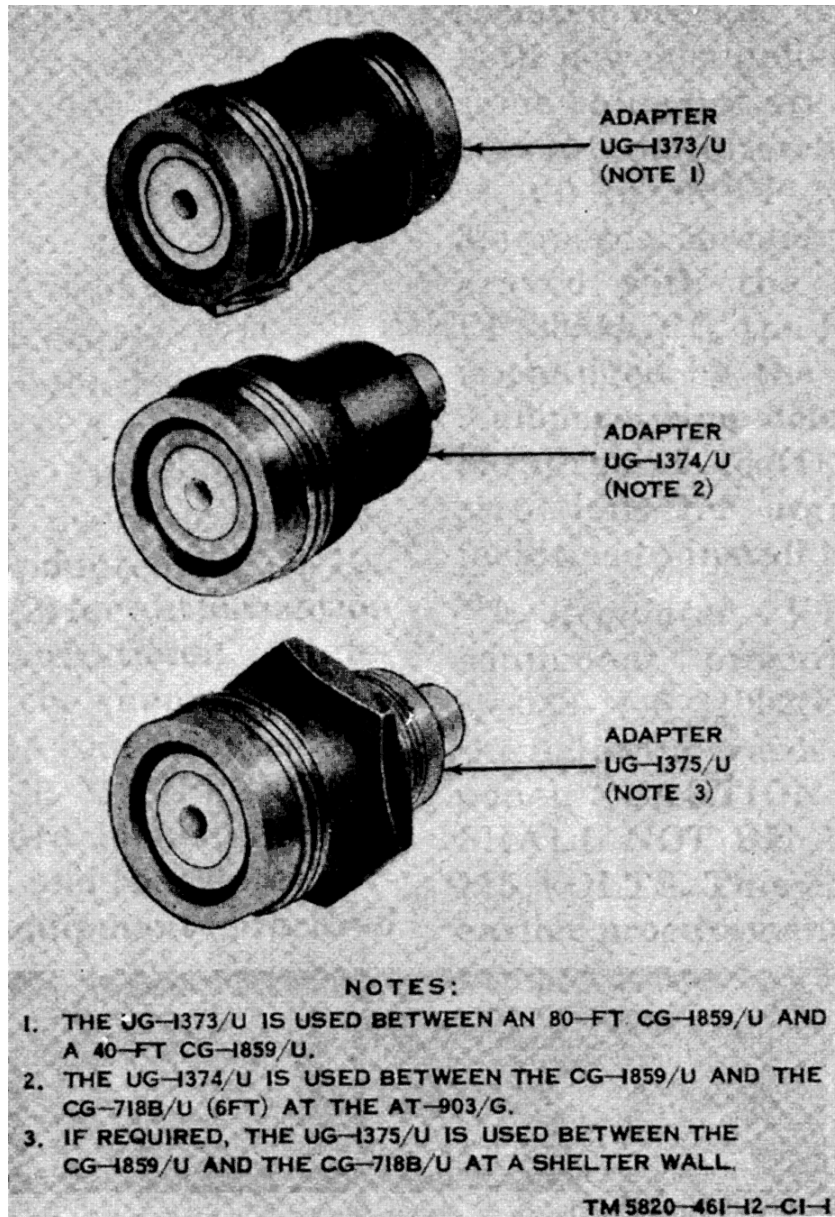

Figure 1-10.1 Adapters UG-1371/U, UG-1374/U, and UG-1375/U.

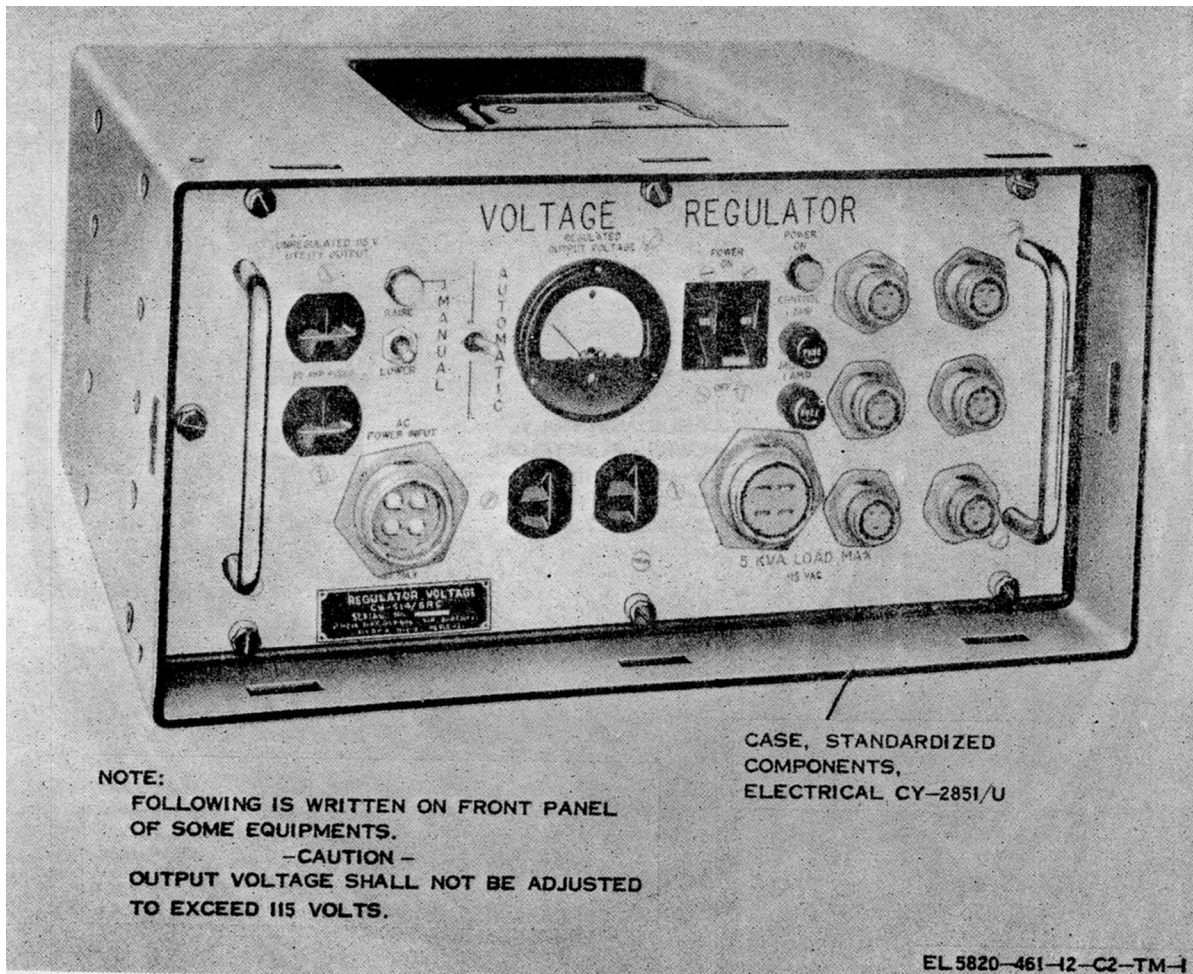

Figure 1-11. Regulator, Voltage CN-514/GRC, less case cover.

Change 3 1-16.1

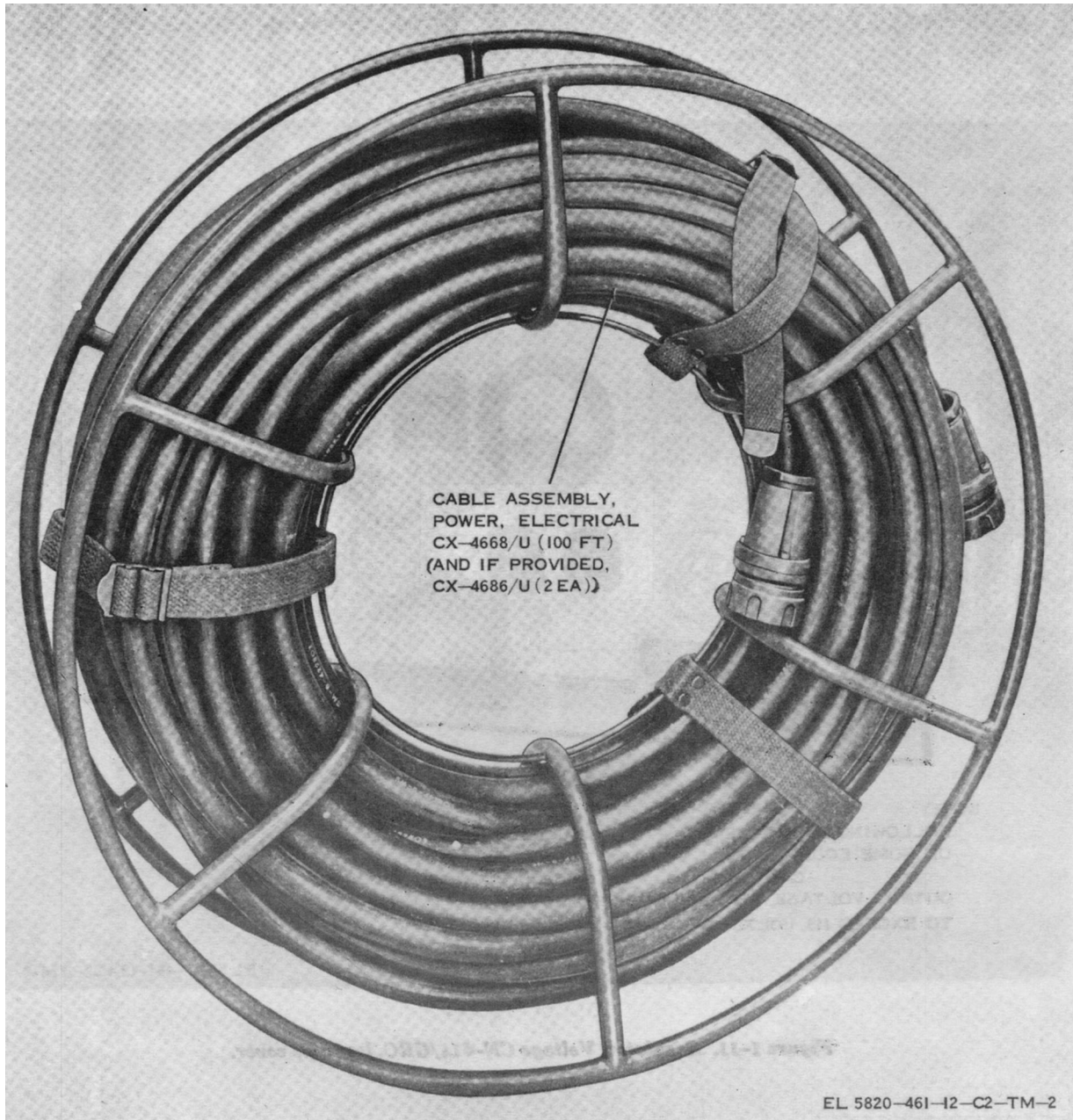

Figure 1-12. Reel, Cable RC-404/TR, with cables mounted on it.

1-16.2 Change 3

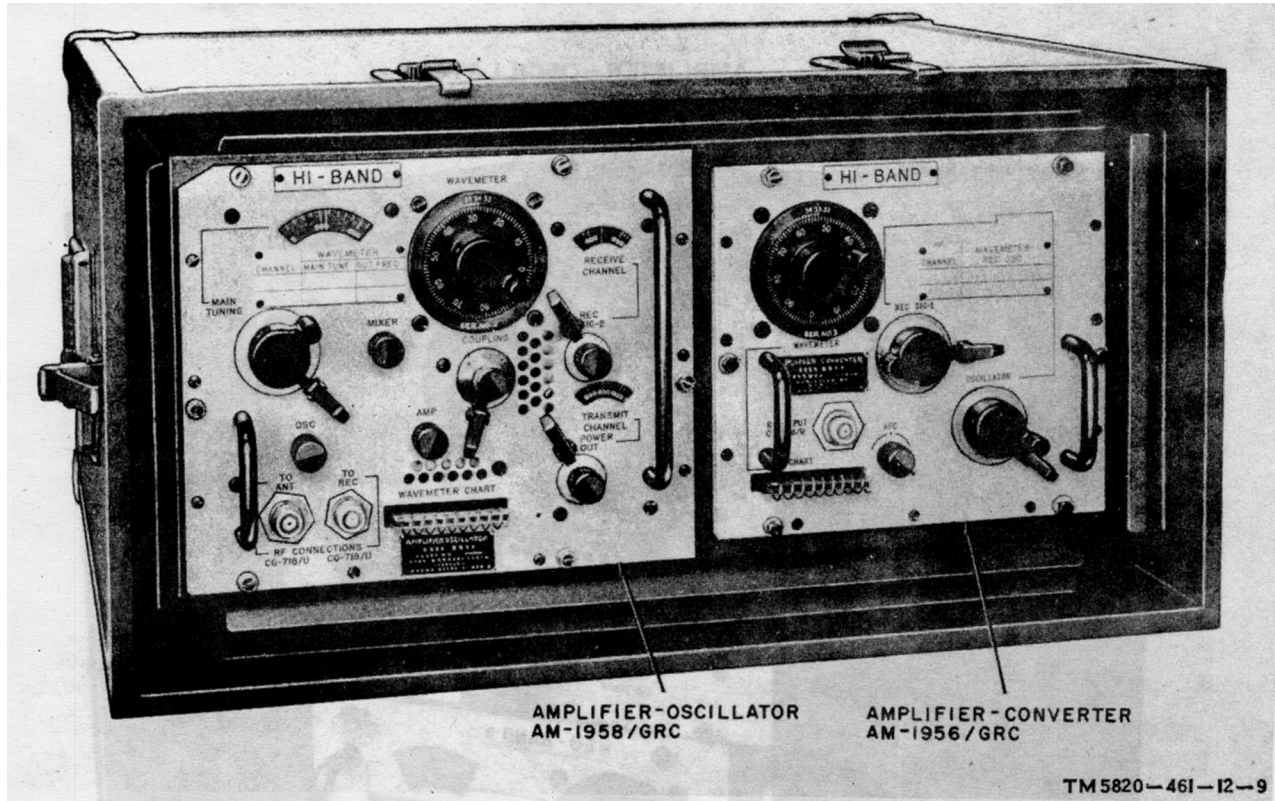

Figure 1-18. Case, Standardized Components, electrical, CY-2582/GRC with alternate turning heads, original design.

AGO 10032A



Figure 1-13.1. Case, Standardized Components, Electrical CY-2582/GRC with alternate tuning heads; later design

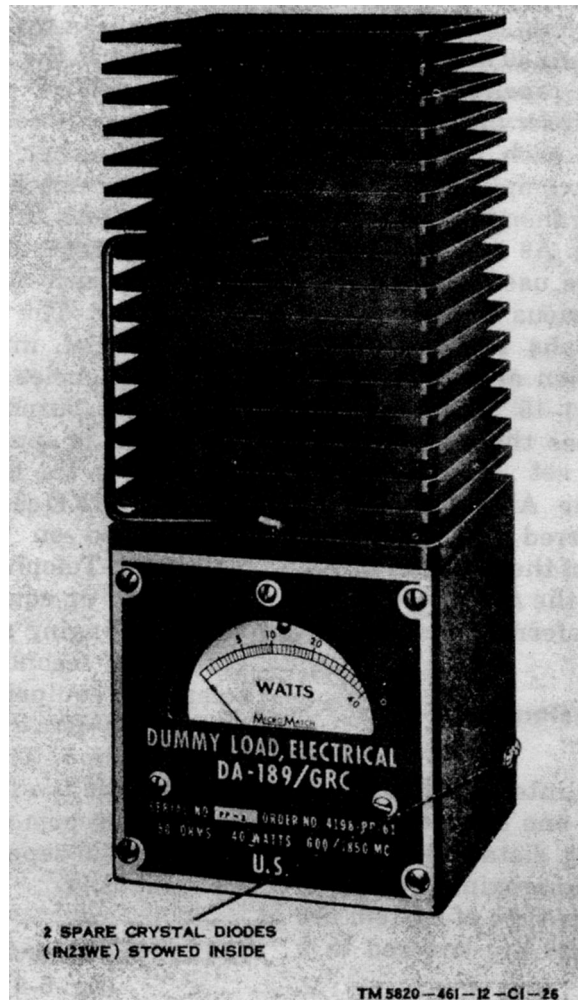

Figure 1-14. Dummy Load, electrical DA-189/GRC.

Change 4 1-19

Section III. SYSTEM APPLICATION

1-15. General

The radio set is designed specifically for system use and generally is not used without supporting multiplex equipment. When the radio set is used in a communications system where the radio link exceeds 30 miles (approximately 50 kilometers), a repeater station is required at each 30-mile interval. In addition to multiplex equipment, each repeater station is equipped with two complete radio sets, to allow simultaneous transmission and reception in two directions. As many as seven repeater stations may be used in a system. The signal paths for various configurations are covered in paragraphs 1-16 and 1-17. Throughout this discussion and accompanying illustrations (figs. 1-15 and 6-1), the equipment that comprises the transmitting portion of the radio set (T-8993(P)/GRC, PP-2054(*)/GRC, and the AM-1957/GRC or AM-1958(*)/GRC) is referred to as the transmitter; the combination of the R-1148(P)/GRC or R-1331(*)/GRC and the AM-1955(*)/GRC or AM-1956(*)/GRC is referred to as the receiver.

1-16. Two-Terminal System (fig. 1-15)

a. *General.* Multiplex intelligence can be transmitted direct from one radio set terminal station to another at distances up to 30 miles (50 kilometers, approximately). The signal paths through this type of system are shown in figure 1-15 and are covered in b through d below.

b. *Fdm.*

(1) Multiplex signals (FDM) from fdm equipment are fed through the receiver to the transmitter (FDM OUT).

(2) The RF carrier of the transmitter, frequency-modulated by the multiplex signals, is coupled through the duplexer to the antenna for propagation towards the distant station.

(3) The signals received by the antenna at the distant station are fed through a duplexer in the transmitter to the receiver (RF). From the receiver, the signals (FDM) are routed to the fdm equipment.

c. *Pcm.* Multiplex transmission signals (PCM IN) from the pcm equipment are fed directly into the transmitter of the radio set. From the transmitter, the signals follow the same path as the fdm signals (b above) and are routed to the associated pcm equipment.

d. *Order-Wire and Ring Signal During Fdm Transmission.* Order wire information is generated either at the local radio set handset or at a remote telephone connected to the receiver. Both these circuits are operable at the same time. The order-wire signals are mixed in with the fdm frequencies in the transmitter. The separation of the received pcm channel information and order-wire voice frequencies is done in the receiver. The order-wire output of the fdm multiplex equipment is applied to the receiver for distribution to the local handset and REMOTE ORDER WIRE connections. If ringing signals are desired on the remote order wire, a Telegraph-Telephone Signal Converter TA-182/U, or equivalent, is required to convert the ringing and alarm signals to the 20 cycles per second (cps) used on the remote telephone equipment.

e. *Order Wire and Ring Signal During Pcm Transmission.* These signals are generated the same as the fdm signals (d above) except that during pcm reception, the order wire information is separated in the pcm multiplex equipment.

1-17. Repeater Station System (fig. 6-1)

a. *General.* When the radio set is used in communications system extending more than approximately 30 miles, a repeater station is required at each 30-mile interval. The signal paths for a system using one repeater station are discussed in b through e below.

b. *Fdm.*

(1) Multiplex signals (FDM) from the fdm equipment at terminal station No. 1 are fed through the receiver to the transmitter (FDM OUT). From the transmitter, the signals are coupled through the duplexer to the antenna for propagation towards the repeater station.

(2) The signals are received by antenna (A) at the repeater station and are fed through a duplexer in transmitter (A) to receiver A (RF). From receiver (A), the signals (FDM) are routed through receiver (B) to transmitter (B). The signals are then coupled through the duplexer to antenna (B) for propagation towards terminal station No. 2.

(3) At terminal station No. 2, the signals are received by the antenna and are fed through a duplexer in the transmitter and then to the receiver (RF). From the receiver, the multiplex signal (FDM) is coupled to fdm equipment. Fdm traffic from terminal station No. 2 to terminal station No. 1 is handled similarly, with the signal path reversed.

c. *Pcm.*

(1) Multiplex signals (PCM IN) from pcm transmitting equipment at terminal station No. 1 are fed through the transmitter and the duplexer to the antenna for propagation towards the repeater station.

(2) The signals received at the repeater station by antenna (A) are coupled through a duplexer in transmitter (A) to receiver (A) (RF). From receiver (A) the signals (PCM OUT) are fed through a pcm multiplexer (A) where they are routed (PCM) with an associated timing signal (TIM) to another pcm multiplexer (B). The resultant signals (PCM IN) are fed through transmitter (B) and propagated towards transmit station No. 2.

(3) At terminal station No. 2, the signals are received by the antenna, fed through a duplexer in the transmitter (RF) to the receiver, and then (PCM OUT) to the pcm multiplex equipment. Pcm traffic from terminal station No. 2 to terminal station No. 1 is handled similarly, with the signal path reversed.

d. *Order-Wire and Ring Signal During FDM Transmission.* The local and remote handsets at a repeater station operate as described in paragraph 1-16d. Both local and remote handsets at a repeater station operate on both system directions.

e. *Order-Wire and Ring Signal during PCM Transmission.* The local and remote handsets at a repeater station operate as described in paragraph 1-16e. The order-wire signals, separated from the pcm signals at the pcm multiplex equipment (A) are returned to the receiver (A) and then routed to the receiver (B) over the FDM lines. One pcm multiplex system, transmitter, and receiver is required at each repeater station for each direction of transmission.

1-18. Interoperation With Radio Set AN/TRC-24 Configurations, Fdm Operation Only

The AN/GRC-50(*) (V) may be interoperated with the AN/TRC-24 which is provided with Radio Set Group AN/TRA-25 or AN/TRA-25A to operate in the AN/TRC-24 F-band or with the Radio Set Group OA3668A/TRC-24 to operate in the AN/TR C-24 24 J-band. This arrangement applies to operation with fdm equipment at the AN/GRC-50(*) (V) There is no provision for pcm operation with the AN/TRC-24 configurations.

a. The following chart shows the frequency bands and corresponding channels within which the AN/GRC-50(*) (V) and AN/TR C-24 24 can communicate:

Frequency (mc)	AN/GRC-50(*) (V)	AN/TRC-24
	Low-band	F-band
790.5	Channel 189 through channel 364	Channel 1 through channel 249 ^a
964.5	High-band	J-band
1,349.5	Channel 400 through channel 899	Channels 1 through 249 on low and medium bands; and channels 1 through 198 on high band ^b .
1,849.5		

^a Only the odd-numbered channels of the F- band may be used.

^b see c(2) (b) below.

b. The chart in a above shows that only channels 189 through 365 of the AN/GRC-50(*) (V) low band and all channels of the high band can be used.

c. When the frequency in megacycles to be used for communication between the two radio sets has been determined, the corresponding channels of the respective radio sets are selected,

- (1) For the AN/GRC 50(*) (V), refer to paragraph 3-6 to determine the corresponding channel.
- (2) For the AN/TRC-24 instructions are given in TM 11-5820-287-12 for channel assignment charts and also for special instructions titled *interoperation untie Radio Set AN/GRC-50*.
 - (a) In the F-band of the AN/TRC-24, only the odd-numbered channels may be used.
 - (b) In the J-band of the AN/TRC-24, the channel settings for the transmitting and receiving frequencies do not exactly correspond to the AN/GRC-50(*) (V) channel frequencies. Thus, before the radio link-lineup, arrangements must be made to decide exactly which AN/TRC-24 frequency will be used and then, during the lineup, which receiver will tune in on the other's transmitter.

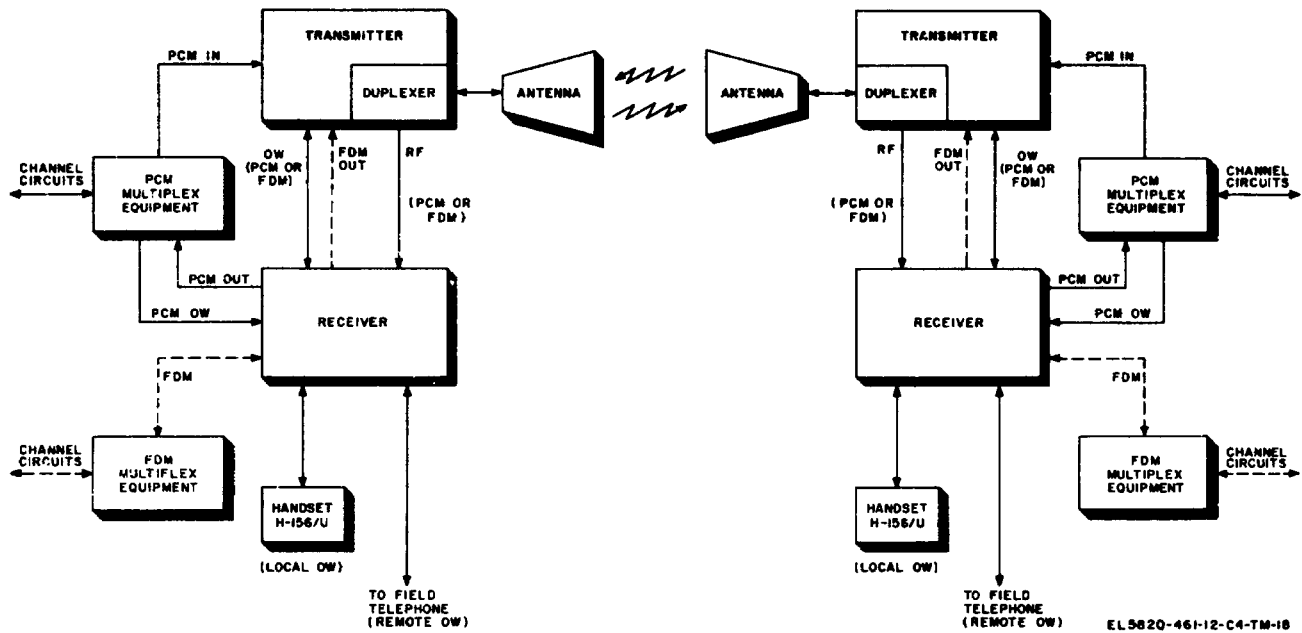

Figure 1-15. System Application using two terminals

**CHAPTER 2
INSTALLATION**

Section I. SERVICE UPON RECEIPT OF EQUIPMENT

2-1. Unpacking

When the radio sets are installed in vans or shelters, refer to unpacking instructions given in the technical manuals applicable to the van or shelter. When the radio set is not installed in a van or shelter, refer to *a* through *b* below.

a. Packaging Data. When packed for shipment, the components of the radio set are placed in cartons and packed in wooden boxes. A typical packing case and its contents are shown in figure 2-1. The packaging data for the AN/GRC-50(V)1 is listed below. The other models are packed similarly. Refer to appendix B for list of items contained in other configurations of the radio set.

Box No.	Dimensions (in.)			Volume (cu ft)	Unit weight (lb.)	Contents of box
	Height	Width	Depth			
1	18	22	24	5.5	135	T-893(P)GRC and AM-1957/GRC
2	18	22	24	5.5	130	R-1148(P)/GRC and AM-1955/GRC; or R-1131(*)/(P)/GRC and AM-1955A/GRC or AM-1955B/GRC.
3	12	22	24	3.56	120	PP-2054(*)/GRC
4	17	18	22	3.89	112	CY-2583/GRC, DA-189/GRC, and BG-102A
5	22	22	26	7.25	119	CY-2582/GRC, AM-1956(*)/GRC, and AM-1958(*)/GRC
6	10	29	27	4.53	100	RC-404/TR
7	22	26	36	11.33	70	AT-903/G
8	26	17	119	30.43	310	AB-577/GRC
9	9	18	17	1.59	109	CN-514/GRC
10	37	14	35	10.49	110	RC-436/GRC
Total weight					1,315	

b. Component Dimensions.

Component	Overall dimensions (in.)			Volume (cu ft)	Weight (lb)
	Height	Width	Depth		
Case, Standardized Components, Electrical CY-2429/GRC	13 3/4	17	20	2.5	19.5
Transmitter, Radio T-893(P)/GRC (without case)	12 3/4	16	17 1/4	2.50	
Amplifier-Oscillator AM-1957/GRC	8 7/8	11	14 3/4	0.8	36.5
Amplifier-Oscillator AM-1958(*)1GRC	8 7/8	11	14 3/4	0.8	35.5
Power Supply PP-2064(*)/GRC (less case)	7 3/4	16	17 1/4	1.25	82
Case, Power Supply CY-2428/GRC	8 1/2	17	20	1.5	16.5
Receiver, Radio R-1148(P)/GRC, or R-1331(*)/(P)/GRC (less case).	12 3/4	16	17 1/4	2	59.25
Amplifier-Converter AM-1955(*)/GRC	8 1/4	9 1/8	13 3/4	0.5	21.25
Amplifier-Converter AM-1956(*)/GRC	8 1/4	9 1/8	13 3/4	0.5	20.75
Antenna AT-9031G	20	24	24	6.3	30

Component	Overall dimensions (in.)			Volume (cu ft)	Weight (lb)
	Height	Width	Depth		
Reel, Cable RW-436/GRC ^a	32	12 diameter	2.1	100
Mast AB-577/GRC.....	95	14 5/16	22 1/16	17.5	240
Regulator, Voltage CN-514/GRC (less case)	7 3/4	16	14	1	89.25
Case Standardized Components, Electrical CY-2851/G .	8 1/2	17	15	1.4	15.75
Reel, Cable RC-404/TR.....	24	6 diameter	0.4	20
Case, Standardized Components, Electrical CY-2582/GRC	18	24	18	4.5	36
Switch Box SA-640/GRC.....	8 1/2	9	9.25	0.5	30
Dummy load, Electrical DA-189/GRC.....	4 1/8	4	10.25	0.1	6.75
Accessory Bag BG-102A ^b	13 1/2	14	9	0.7	25
Case Standardized Components Electrical CY-2583/GRC ^c .	5	17	20	0.98	25

^a Includes cables connectors and adapters.

^b Includes accessories.

^c Includes running spares and accessories.

c. *Removing Contents.* Perform the following procedures when unpacking the equipment:

- (1) Select a location that is convenient to the installation of the equipment and where the equipment may be unpacked without exposure to bad weather.
- (2) Cut and fold back the metal straps. Use a pair of tin snips or a large pair of diagonal-cutting pliers.
- (3) Remove the nails from the top and one side of the box with a nailpuller. Remove the top and one side.

Caution: Do not attempt to pry off the top and side of the box without removing the nails because the equipment may become damaged.

- (4) Lift out the moisture-proof barrier containing the outer carton.
- (5) Remove the gum seal on the moisture-proof barrier and remove the outer carton.
- (6) Open the carton and remove the moisture-vaporproof barrier containing the inner carton. Remove the inner carton. Open the inner carton and remove the contents.

2-2. Checking Unpacked Equipment

a. Inspect the equipment for possible damage incurred during shipment. If the equipment has been damaged, refer to paragraph 1-3 for the applicable forms and records.

b. Check to see that the equipment is complete as listed on the packing slip. If a packing slip is not available, check the equipment against the basic issue items list (app B).

c. If the equipment has been used or reconditioned, see whether it has been changed by a modification work order (MWO), in which case the MWO number will appear on the front panel near the nomenclature plate.

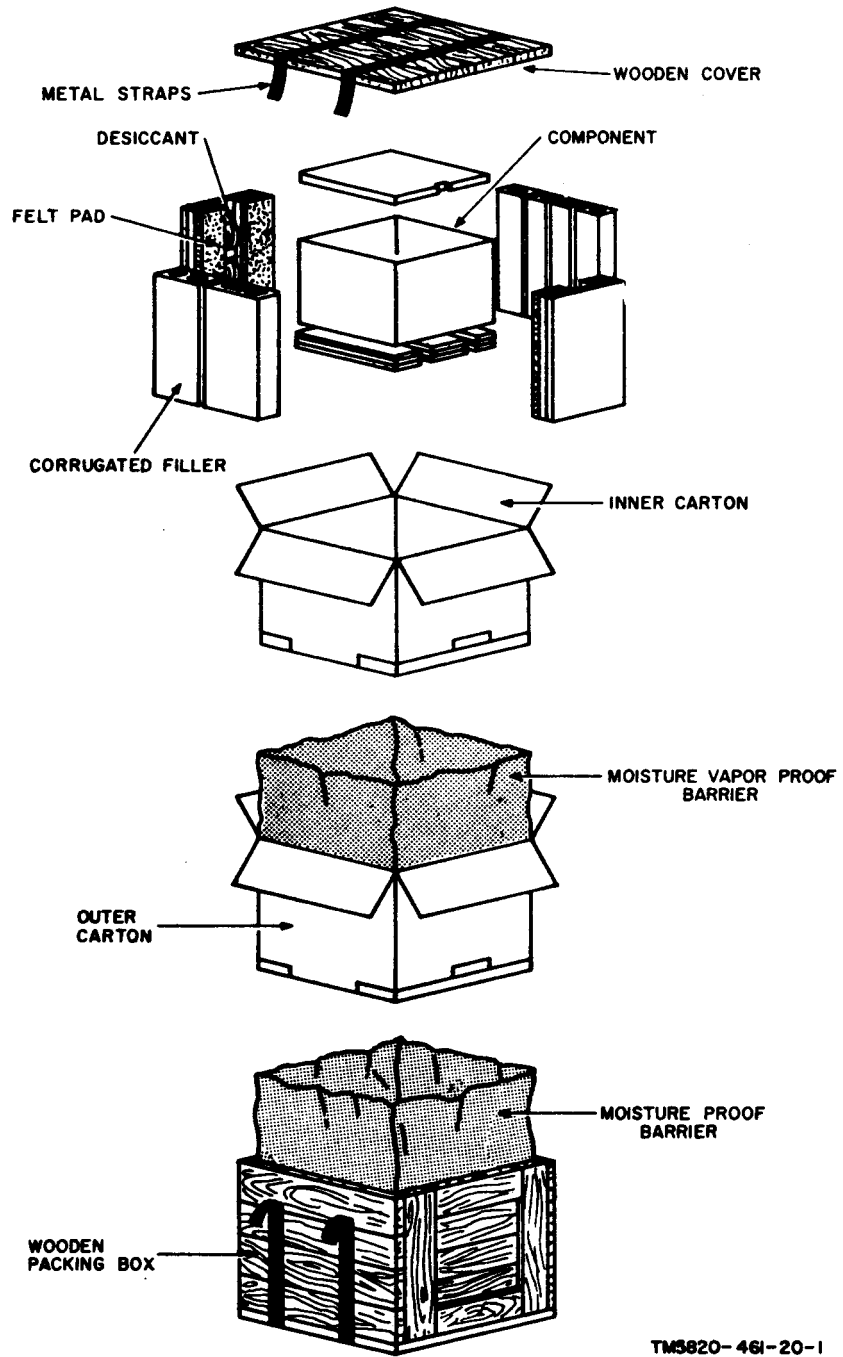

Figure 2-1. Typical packaging diagram.

Section II. INSTALLATION WARNING

I. Safety precautions must be observed when erecting and using the antenna assembly. DEATH can easily occur if the antenna assembly comes in contact with electric powerlines.

Prior to erection of this antenna assembly, survey the area carefully for location of powerlines, their height above ground level, and their proximity to the installation site. The antenna assembly must be installed as far away as possible from electric powerlines, but never closer than twice its height.

The antenna assembly is 49.5, 51, 76.5, or 78 feet tall (depending upon which components are used), so it should never be erected closer than 2 times the height of the structure from the base of the nearest powerlines.

When erection in the vicinity of the powerlines cannot be avoided, the responsible authority will warn all personnel who are to participate in the exercise that contact by the structure with powerlines can cause serious injury or death.

II. Guy lines will be kept as far away from powerlines as possible to reduce the possibility of a powerline falling across a guy line.

NEVER touch a structure or any attachment connected to it if the possibility exists that it may be accidentally electrically energized. The area around the structure that is suspected of being energized should be roped off and guards should be posted to prevent anyone from entering the area. Immediately thereafter proper authorities should be notified so that remedial action can be taken.

NEVER engage in work on a structure during an electrical storm or when a storm is imminent.

Personnel engaged in installation of the antenna assembly should be adequately instructed by responsible authority as to the overall method of erection and the specific hazards encountered. Under no circumstances should the erection be attempted with fewer than two persons erecting the mast, and three persons available to hold the ends of the guys, while the mast is being erected. Use of fewer personnel may result in serious injury to the participating personnel or major damage to the equipment. Only personnel required for erection will be in the erection area. All other nonessential personnel must stand clear of the area. During erection of the antenna assembly, conform to all safety requirements set forth in TB SIG 291.

Plan the installation so that as much of the assembly of the structure as possible is accomplished on the ground. Where situations make it necessary to work aloft, thought should be given to the selection of a suitable working location on the structure so that unnecessary climbing or movement can be avoided. Plan each aerial operation so that unnecessary work aloft is avoided.

NEVER walk directly beneath the structure during erection. NEVER stand beneath anything being hoisted. When an assembly, or member, is raised or lowered either by winch or hand, one person should attend the hauling line. This condition will keep the area around the workers feet clear and prevent the person from being entangled. When lowering an assembly or member by the winch, keep the hands as far away from the winch cable reel as possible. NEVER overload the antenna assembly by installing additional sections or assemblies than those authorized.

NEVER attempt to support a structure using fewer guys than prescribed. All guys and the hoisting cable will be inspected for worn spots, frays, rotten portions (ropes only), and any other Imperfections prior for to being placed in use. Do not use any guys and hoisting cable that show any of the imperfections. Do not fasten guys (especially ropes over sharp-edged surfaces which may abraid or cut the guys and cause their failure. If in the course of erection it becomes necessary to suspend operations, sufficient guys must be attached to support the structure safely.

All anchors must be securely entrenched in the ground. In marshy or sandy terrain, special provisions must be made to obtain required anchor holding strength. When selecting anchor locations for guys, avoid locations that will cause the guys to pass over roadways. When these locations cannot be avoided, maximum road clearance must be maintained. Plainly marked guys with orange paint and red flag warning signs, indicating overhead obstructions and their height over the roadway, will be posted.

When making installations in a region known for its heavy icing conditions, thought should be given to providing extra support to the assembly, prior to erection. When an assembly becomes heavily iced, the surrounding area should be roped off and marked "BEWARE OF FALLING ICE."

III. Basic Rescue Rules. In the event an individual comes in contact with an electrically energized structure, follow the procedures below in the order as listed:

- a. NEVER attempt to grasp or pull free the individual--such an action can cause instant death to the rescuer.
- b. If possible, turn off the electrical power. If not, try to free the individual by using a wooden pole, rope, or some other insulated object.
- c. After freeing the individual, immediately start artificial resuscitation and send for help.

2-3 Preliminary Installation Data

The selection of a site and the design of the installation should be undertaken only by trained personnel. The following instructions are general and will apply to any site.

a. *General.* The siting requirements for the radio sets are determined before any actual installation of equipment. Information required for siting includes profile plotting, selection of operating frequencies, system applications, drop channel facilities, and terminal locations. Information is contained in TM 11-486-6 for preparing the site installation order.

b. *Antenna Siting.* The locations of the antennas in an overall radio relay system are extremely important for consistent communication. The installation order supplied for each of the proposed sites should contain the elevation or depression angle, polarization of the antenna, and relative direction. These data are covered in (1) through (3) below:

(1) *Antenna polarization.* Antenna AT-903/G may provide horizontal or vertical polarization, depending on the way it is mounted (fig. 1-7). The antenna polarization between two stations must be the same. For example, if the transmitting station antenna is horizontally polarized, the receiving station antenna also must be horizontally polarized. When two or more radio sets are placed at the same site, one antenna should be vertically polarized to provide isolation and avoid interference. Approximately 20 to 25 decibel (db) signal attenuation is attained by the cross-polarization.

(2) *Antenna depression-elevation angle.* Antenna AT-903/G may be elevated or depressed in graduated steps to provide correct antenna relationships between relay stations of the radio system. The amount of elevation or depression required for an individual antenna may be determined from the graph in figure 6-2. The angle of depression will be the same as the angle of elevation for the preceding antenna. Refer to figure 6-2 for the two examples listed below.

(a) *Example I.*

1. Assume that station A is separated from station B by 28 miles (distance between antenna sites). Also assume that station B is elevated above station A by 2 miles (elevation difference between antenna sites).
2. In the horizontal column D, locate the 28-mile point.
3. Project a vertical line from the 28-mile point.
4. In the vertical column D, locate the 2-mile point.
5. Project a horizontal line from the 2-mile point.
6. The point of intersection of the two projected lines will indicate the depression elevation angle.
7. Station A will set the antenna elevation angle to 4°.
8. Station B will set the antenna depression angle to 4°.

(b) *Example II.*

1. Assume that station A is separated by 3,100 feet from station B. Also assume that station A is above station B by 500 feet.

2. Along the horizontal column B, locate the 3,100-foot point and project a vertical line from this point.
3. Along the vertical column B, locate the 500-foot point and project a horizontal line from this point.
4. The point of intersection of the two projected lines indicates a depression-elevation angle of 8°.
5. Station A will use an antenna depression angle of 8°, and station B will use an antenna elevation of 8°.

(3) *Coarse azimuth alignment.* Exact antenna orientation is performed during the system lineup (20, para 3-6). To obtain a coarse antenna direction when the desired bearing is not known, use the following procedure:

- (a) Obtain the desired bearing by reference to a topographical map. When the bearing is determined, install a marker about 150 feet away from the selected antenna site with the aid of a compass.

(b) When installing the first guy anchor for the antenna mast, place it in line with the antenna base marker.

c. *Frequency Selection Restrictions.*

(1) *Assigning frequencies.* Operating frequencies should be selected at the 0.5-mc points of the frequency band of the radio sets (601.5 through 999.5 and 1,350.5 through 1,849.5 mc). Refer to paragraph 3-6 for the formula used to convert frequencies to channels and vice versa. For example: select 660.5 or 661.5 mc; do not select 660 or 661 mc. For tuning of the radio set, every frequency selection ending with .5 mc can be converted to a channel. No provision is made for converting a frequency that does not end with .5 mc to a channel number. If a frequency assignment has been made, for example, at 710 mc the operators at both radio terminals must decide before performing tuning procedures whether they will use 709.5 or 710.5 as their operating frequency. Without this arrangement, communication will be delayed until the operators find each other by trial and error; at which time, they will have to realign their radio sets.

(2) *Restricted channels/frequencies.* The chart in (3) below lists the channel and its corresponding frequency (in mc). For each channel/frequency is listed the corresponding channels/frequencies which are detrimental to operation of a receiver, and which are caused by the interference of the signal from a transmitter either in the same stack or in a nearby radio set. The restrictions in (a) through (c) below must be maintained for a transmitter and receiver in the same stack.

Note. For radio sets that are at the same site (such as a repeater station or a group of terminal station radio sets in one area), the restrictions in (b), (c), and (d) below most likely, would not apply if the radio sets of the conflicting channels/frequencies operate with their antennas polarized differently. That is, if one of the potentially interfering radio sets has its antenna polarized vertically, the other must be polarized horizontally. Such an arrangement provides approximately 20 to 25 db attenuation between the antenna signals.

(a) The -15 to +15 column lists the 30-mc channel/frequency band (15 on both sides of each channel/frequency) within which the receiver must not be tuned to the transmitter in the same stack or nearby radio set.

(b) The +50 (±3) and +100 (±3) columns are restrictions based on the susceptibility of the receiver to be blocked by its own or nearby transmitter signal and thus preventing the receiver from receiving the signal transmitted from the distant radio station. Refer to the note in (2) above.

(c) The +60 (±3) and +120 (±3) columns list the restriction for image frequencies. After the system has been lined up and the transmission from the distant station is interrupted, it is possible for the receiver to lock on to its own or another transmitter in which the transmitting frequency is 60 or 120 mc ±3 below the receiver frequency; that is, the receiver is 60 or 120 mc ±3 above the transmitter frequency. When the distant transmitter operation is restored, the receiver will not respond to its signal because it is locked on to another transmitter. To prevent this lock-on, the receiver must not be assigned an operating frequency that is 60 or 120 ±3 mc above its own or a nearby transmitter frequency. Refer to the note in (2) above.

(d) The cross modulation restriction is required when the radio set is situated at a repeater station or at a site where other radio sets are located. The power of the transmitted signal developed by cross modulation may cause damage to a receiver's crystal. The restriction is similar to the requirement to keep the receiver frequency separated from the transmitter frequency by at least 15 mc ((a) above). Cross modulation results when the second harmonic of one transmitter at a repeater site is mixed with the fundamental frequency of another transmitter at the same repeater site. If the frequency difference of the mixture of the two transmitter signals is within 15 mc of a receiver frequency, the receiver crystal may be damaged. An example of frequency selection for a repeater station is given below.

Component	Frequency (mc)
Transmitter A	660.5
Receiver A	640.5
Transmitter B	750.5
Receiver B	550.5

1. Assume that the second harmonic of transmitter A is mixed with the fundamental (transmitter) frequency of transmitter B. The resultant difference $((2 \times 660.5) - 750.5)$ will be 570.5 mc This difference frequency is not within 15 mc of either receiver A or receiver B.

2. Assume that the second harmonic of transmitter B is mixed with the fundamental frequency of transmitter A $((2 \times 750.5) - 660.5)$. The resultant difference will be 840.5 mc This difference frequency also is not within 15 mc of either receiver A or receiver B; therefore, the frequency selection given in the chart in (d) above is acceptable for a repeater station.

3. With the same transmitter frequencies, it follows that 570.5 mc (1 above) is outside the radio set band, but 840.5 mc (2 above) could not be used for a receiver at the repeater station.

4. Refer to the note in (2) above.

(3) *Restricted channels/frequencies chart.* In addition to the separation restrictions given in (2) above and the following chart, it is also recommended that the receiver channel/frequency separation of +30 (± 3) and +40 (± 3) be observed. Interference at these points usually occurs. Note that the loop-back tuning procedures in paragraph 3-11 permit the use of the image frequency (+120) for local testing only.

Low-band transmitter		Receiver channel/frequency				
Frequency	Channel	Required separation				
		-15 to +15	+50 (± 3)	+60 (± 3)	+100 (± 3)	+120 (± 3)
601.5	1	1-16	48-64	58-64	98-104	118-124
		601.5-616.5	648.5-654.5	658.5-664.5	698.5-704.5	718.5-724.5
602.5	2	1-17	49-56	59-65	99-105	119-125
		601.5-617.5	649.5-665.5	669.5-666.5	699.5-705.5	719.5-725.5
603.5	3	1-18	50-66	60-66	100-106	120-126
		601.5-618.5	660.5-666.5	660.5-666.5	700.5-706.5	720.5-726.5
604.5	4	1-19	61-67	61-67	101-107	121-127
		601.5-619.5	661.5-667.5	661.5-667.5	701.5-707.5	721.5-727.5

C1, TM 11-5820-461-12

Low -band transmitter		Receiver channel/frequency				
Frequency	Channel	Required separation				
		-15 to +15	+50 (±3)	+60 (±3)	+100 (±3)	+120 (±3)
	5	1-20	52-58	62-68	102-108	122-128
605.5	----	601.5-620.5	652.5-658.5	662.5-668.5	702.5-708.5	722.5-728.5
	6	1-21	53-59	63-69	103-109	123-129
606.5	----	601.5-621.5	653.5-659.5	663.5-669.5	703.5-709.5	723.5-729.5
	7	1-22	54-60	64-70	104-110	124-130
607.5	----	601.5-622.5	654.5-660.5	664.5-670.5	704.5-710.5	724.5-730.5
	8	1-23	55-61	65-71	105-111	126-131
608.5	----	601.5-623.5	655.5-661.5	665.5-671.5	705.5-711.5	725.5-731.5
	9	1-24	56-62	66-72	106-112	126-132
609.5	----	601.5-624.5	656.5-662.5	666.5-672.5	706.5-712.5	726.5-732.5
	10	1-26	57-63	67-73	107-118	127-133
610.5	----	601.5-625.5	657.5-663.5	667.5-673.5	707.5-713.5	727.5-733.5
	11	1-26	58-64	68-74	108-114	128-134
611.5	----	601.5-626.5	658.5-664.5	668.5-674.5	708.5-714.5	728.5-734.5
	12	1-27	59-65	69-75	109-115	129-135
612.5	----	601.5-627.5	659.5-665.5	669.5-675.5	709.5-715.5	729.5-735.5
	13	1-28	60-66	70-76	110-116	130-136
613.5	----	601.5-628.5	660.5-666.5	670.5-676.5	710.5-716.5	730.5-736.5
	14	1-29	61-67	71-77	111-117	131-137
614.5	----	601.5-629.5	661.5-667.5	671.5-677.5	711.5-717.5	731.5-737.5
	15	1-30	62-68	72-78	112-118	132-138
615.5	----	601.5-630.5	662.5-668.5	672.5-678.5	712.5-718.5	732.5-738.5
	16	1-31	63-69	73-79	113-119	135-139
616.5	----	601.5-631.5	663.5-669.5	673.5-679.5	713.5-719.5	733.5-739.5
	17	2-32	64-70	74-80	114-120	134-140
617.5	----	602.5-632.5	664.5-670.5	674.5-680.5	714.5-720.5	734.5-740.5
	18	3-33	65-71	75-81	115-121	135-141
618.5	----	603.5-633.5	665.5-671.5	675.5-681.5	715.5-721.5	735.5-741.5
	19	4-34	66-72	76-82	116-122	136-142
619.5	----	604.5-634.5	666.5-672.5	676.5-682.5	716.5-722.5	736.5-742.5
	20	5-35	67-73	77-83	117-123	137-143
620.5	----	605.5-635.5	667.5-673.5	677.5-683.5	717.5-723.5	737.5-743.5
	21	6-36	68-74	78-84	118-124	138-144
621.5	----	606.5-636.5	668.5-674.5	678.5-684.5	718.5-724.5	738.5-744.5
	22	7-37	69-75	79-85	119-125	139-145
622.5	----	607.5-637.5	669.5-675.5	679.5-685.5	719.5-725.5	739.5-745.5
	23	8-38	70-76	80-86	120-126	140-146
623.5	----	608.5-638.5	670.5-676.5	680.5-686.5	720.5-726.5	740.5-746.5
	24	9-39	71-77	81-87	121-127	141-147
624.5	----	609.5-639.5	671.5-677.5	681.5-687.5	721.5-727.5	741.5-747.5
	25	10-40	72-78	82-88	122-128	142-148
625.5	----	610.5-640.5	672.5-678.5	682.5-688.5	722.5-728.5	742.5-748.5
	26	11-41	73-79	83-89	123-129	143-149
626.5	----	611.5-641-5	673.5-679.5	683.5-689.5	723.5-729.5	743.5-749.5
	27	12-42	74-80	84-90	124-130	144-150
627.5	----	612.5-642.5	674.5-680.5	684.5-690.5	724.5-730.5	744.5-750.5
	28	13-43	75-81	85-91	125-131	145-151
628.5	----	613.5-643.5	675.5-681.5	685.5-691.5	725.5-731.5	745.5-751.5
	29	14-44	76-82	86-92	126-132	146-152
629.5	----	614.5-644.5	676.5-682.5	686.5-692.5	726.5-732.5	746.5-752.5
	30	15-45	77-83	87-93	127-133	147-153
630.5	----	615.5-645.5	677.5-683.5	687.5-693.5	727.5-733.	747.5-753.5
	31	16-46	78-84	88-94	128-134	148-154
631.5	----	616.5-646.5	678.5-684.5	688.5-694.5	728.5-734.5	748.5-754.5

AGO 10032A

Low -band transmitter		Receiver channel/frequency				
Frequency	Channel	Required separation				
		-15 to +15	+50 (±3)	+60 (±3)	+100 (±3)	+120 (±3)
	32	17-47	79-85	89-95	129-135	149-155
632.5	----	617.5-647.5	679.5-685.5	689.5-695.5	729.5-735.5	749.5-755.5
	33	18-48	80-86	90-96	130-136	150-156
633.5	----	618.5-648.5	680.5-686.5	690.5-696.5	730.5-736.5	750.5-756.5
	34	19-49	81-87	91-97	131-137	151-157
634.5	----	619.5-649.5	681.5-687.5	691.5-697.5	731.5-737.5	751.5-757.5
	35	20-50	82-88	92-98	132-138	152-158
635.5	----	620.5-650.5	682.5-688.5	692.5-698.5	782.5-738.5	752.5-758.5
	36	21-51	83-89	93-99	133-139	153-159
636.5	----	621.5-651.5	683.5-689.5	693.5-699.5	733.5-739.5	753.5-759.5
	37	22-52	84-90	94-100	134-140	154-160
637.5	----	622.5-652.5	684.5-690.5	694.5-700.5	734.5-740.5	754.5-760.5
	38	23-53	85-91	95-101	135-141	155-161
638.5	----	623.5-653.5	685.5-691.5	695.5-701.5	735.5-741.5	755.5-761.5
	39	24-54	86-92	96-102	136-142	156-162
639.5	----	624.5-654.5	686.5-692.5	696.5-702.5	736.5-742.5	756.5-762.5
	40	25-55	87-93	97-103	137-143	157-163
640.5	----	625.5-655.5	687.5-693.5	697.5-703.5	737.5-743.5	757.5-763.5
	41	26-56	88-94	98-104	138-144	158-164
641.5	----	626.5-666.5	688.5-694.5	698.5-704.5	738.5-744.5	758.5-764.5
	42	27-57	89-95	99-105	139-145	159-165
642.5	----	627.5-657.5	689.5-695.5	699.5-705.5	739.5-745.5	759.5-765.5
	43	28-58	90-96	100-106	140-146	160-166
643.5	----	628.5-658.5	690.5-696.5	700.5-706.5	740.5-746.5	760.5-766.5
	44	29-59	91-97	101-107	141-147	161-167
644.5	----	629.5-659.5	691.5-697.5	701.5-707.5	741.5-747.5	761.5-767.5
	45	30-60	92-98	102-108	142-148	162-168
645.5	----	630.5-660.5	692.5-698.5	702.5-708.5	742.5-748.5	762.5-768.5
	46	31-61	93-99	103-109	143-149	163-169
646.5	----	631.5-661.5	693.5-699.5	703.5-709.5	743.5-749.5	763.5-769.5
	47	32-62	94-100	104-110	144-150	164-170
647.5	----	632.5-662.5	694.5-700.5	704.5-710.5	744.5-750.5	764.5-770.5
	48	33-63	95-101	105-111	145-151	165-171
648.5	----	633.5-663.5	695.5-701.5	705.5-711.5	745.5-751.5	765.5-771.5
	49	34-64	96-102	106-112	146-152	166-172
649.5	----	634.5-664.5	696.5-702.5	706.5-712.5	746.5-752.5	766.5-772.5
	60	35-65	97-103	107-113	147-153	167-173
660.5	----	636.5-666.5	697.5-703.5	707.5-713.5	747.5-753.5	767.5-773.5
	61	36-66	98-104	108-114	148-154	168-174
661.5	----	636.5-666.5	698.5-704.5	708.5-714.5	748.5-754.5	768.5-774.5
	52	37-67	99-105	109-115	149-155	169-175
652.5	----	637.5-667.5	699.5-705.5	709.5-715.5	749.5-755.5	769.5-775.5
	53	38-68	100-106	110-116	150-156	170-176
653.5	----	638.5-668.5	700.5-706.5	710.5-716.5	750.5-756.5	770.5-776.5
	54	39-69	101-107	111-117	151-157	171-177
654.5	----	639.5-669.5	701.5-707.5	711.5-717.5	751.5-757.5	771.5-777.5
	55	40-70	102-108	112-118	152-158	172-178
655.5	----	640.5-670.5	702.5-708.5	712.5-718.5	752.5-758.5	772.5-778.5
	56	41-71	103-109	113-119	153-159	173-179
656.5	----	641.5-671.5	703.5-709.5	713.5-719.5	753.5-759.5	773.5-779.5
	57	42-72	104-110	114-120	154-160	174-180
657.5	----	642.5-672.5	704.5-710.5	714.5-720.5	754.5-760.5	774.5-780.5
	58	43-73	105-111	115-121	155-161	175-181
658.5	----	643.5-673.5	705.5-711.5	715.5-721.5	755.5-761.5	775.5-781.5

AGO 10032A

Low -band transmitter		Receiver channel/frequency				
Frequency	Channel	Required separation				
		-15 to +15	+50 (±3)	+60 (±3)	+100 (±3)	+120 (±3)
	59	44-74	106-112	116-122	156-162	176-182
659.5	----	644.5474.5	706.5-712.5	716.5-722.5	756.5-762.5	776.5-782.5
	60	45-75	107-113	117-123	157-163	177-183
660.5	----	646.5-675.5	707.5-713.5	717.5-723.5	767.5-763.5	777.5-783.5
	61	46-76	108-114	118-124	168-164	178-184
661.5	----	646.5-676.5	708.5-714.5	718.5-724.5	758.5-764.5	778.5-784.5
	62	47-77	109-116	119-126	169-165	179-185
662.5	----	647.5-677.5	709.5-716.5	719.5-726.5	759.5-765.5	779.5-785.5
	63	48-78	110-116	120-126	160-166	180-186
663.5	----	648.5-678.5	710.5-716.5	720.5-726.5	760.5-766.5	780.5-786.5
	64	49-79	111-117	121-127	161-167	181-187
664.5	----	649.5-679.5	711.5-717.5	721.5-727.5	761.5-767.5	781.5-787.5
	65	60-80	112-118	122-128	162-168	182-188
665.5	----	660.5-680.5	712.5-718.5	722.5-728.5	762.5-768.5	782.5-788.5
	66	61-81	118-119	123-129	163-169	183-189
666.5	----	651.5-681.5	713.5-719.5	723.5-729.5	763.5-769.5	783.5-789.5
	67	62-82	114-120	124-130	164-170	184-190
667.5	----	662.5-682.5	714.5-720.5	724.5-730.5	764.5-770.5	784.5-790.5
	68	68-88	115-121	126-131	166-171	186-191
668.5	----	663.5-683.5	715.5-721.5	725.5-731.5	765.5-771.5	785.5-791.5
	69	54-84	116-122	126-132	166-172	186-192
669.5	----	654.5-684.5	716.5-722.5	726.5-732.5	766.5-772.5	786.5-792.5
	70	56-85	117-123	127-133	167-173	187-193
670.5	----	665.5-685.5	717.5-723.5	727.5-733.5	767.5-773.5	787.5-793.5
	71	56-86	118-124	128-134	168-174	188-194
671.5	----	656.5-686.5	718.5-725.5	728.5-734.5	768.5-774.5	788.5-794.5
	72	67-87	119-125	129-135	169-175	189-195
672.5	----	657.5-687.5	719.5-725.5-	729.5-735.5	769.5-776.5	789.5-795.5
	73	58-88	120-126	130-136	170-176	190-196
673.5	----	658.5-688.5	720.5-726.5	730.5-736.5	770.5-776.5	790.5-796.5
	74	59-89	121-127	131-137	171-177	191-197
674.5	----	659.5-689.5	721.5-727.5	731.5-737.5	771.5-777.5	791.5-797.5
	75	60-90	122-128	132-138	172-178	192-198
675.5	----	660.5-690.5	722.5-728.5	732.5-738.5	772.5-778.5	792.5-798.5
	76	61-91	123-129	133-139	173-179	193-199
676.5	----	661.5-691.5	723.5-729.5	733.5-739.5	773.5-779.5	793.5-799.5
	77	62-92	124-130	134-140	174-180	194-200
677.5	----	662.5-692.5	724.5-730.5	734.5-740.5	774.5-780.5	794.5-800.5
	78	63-93	126-131	135-141	175-181	195-201
678.5	----	663.5-693.5	726.5-731.5	736.5-741.5	775.5-781.5	795.5-801.5
	79	64-94	126-132	136-142	176-182	196-202
679.5	----	664.5-694.5	726.5-732.5	736.5-742.5	776.5-782.5	796.5-802.5
	80	66-95	127-133	137-143	177-183	197-203
680.5	----	665.5-695.5	727.5-733.5	737.5-743.5	777.5-783.5	797.5-803.5
	81	66-96	128-134	138-144	178-184	198-204
681.5	----	666.5-696.5	728.5-734.5	738.5-744.5	778.5-784.5	798.5-804.5
	82	67-97	129-135	139-145	179-185	199-205
682.5	----	667.5-697.5	729.5-735.5	739.5-746.5	779.5-785.5	799.5-805.5
	83	68-98	130-136	140-146	180-186	200-206
683.5	----	668.5-698.5	730.5-736.5	740.5-746.5	780.5-786.5	800.5-806.5
	84	69-99	131-137	141-147	181-187	201-207
684.5	----	669.5-699.5	731.5-737.5	741.5-747.5	781.5-787.5	801.5-807.5
	85	70-100	132-138	142-148	182-188	202-208
685.5	----	670.5-700.5	732.5-738.5	742.5-748.5	782.5-788.5	802.5-808.5

AGO 10032A

Low -band transmitter		Receiver channel/frequency				
Frequency	Channel	Required separation				
		-15 to +15	+50 (±3)	+60 (±3)	+100 (±3)	+120 (±3)
686.5	86	71-101	133-139	143-149	183-189	203-209
	----	671.5-701.5	733.5-739.5	743.5-749.5	783.5-789.5	803.5-809.5
687.5	87	72-102	134-140	144-150	184-190	204-210
	----	672.5-702.5	734.5-740.5	744.5-760.5	784.5-790.5	804.5-810.5
688.5	88	73-103	136-141	145-151	186-191	205-211
	----	673.5-703.5	735.5-741.5	745.5-751.5	785.5-791.5	805.5-811.5
689.5	89	74-104	136-142	146-152	186-192	206-212
	----	674.5-704.5	736.5-742.5	746.5-762.5	786.5-792.5	806.5-812.5
690.5	90	76-106	137-143	147-153	187-193	207-213
	----	675.5-706.5	737.5-743.5	747.5-753.5	787.5-793.5	807.5-813.5
691.5	91	76-106	138-144	148-154	188-194	208-214
	----	676.5-706.5	738.5-744.5	748.5-764.5	788.5-794.5	808.5-814.5
692.5	92	77-107	139-145	149-155	189-195	209-215
	----	677.5-707.5	739.5-746.5	749.5-766.5	789.5-796.5	809.5-815.5
693.5	93	78-108	140-146	150-156	190-196	210-216
	----	678.5-708.5	740.5-746.5	760.5-766.5	790.5-796.5	810.5-816.5
694.5	94	79-109	141-147	151-157	191-197	211-217
	----	679.5-709.5	741.5-747.5	751.5-757.5	791.5-797.5	811.5-817.5
695.5	95	80-110	142-148	152-158	192-198	212-218
	----	680.5-710.5	742.5-748.5	762.5-768.5	792.5-798.5	812.5-818.5
696.5	96	81-111	143-149	153-159	193-199	213-219
	----	681.5-711.5	743.5-749.5	753.5-769.5	793.5-799.5	813.5-819.5
697.5	97	82-112	144-150	154-160	194-200	214-220
	----	682.5-712.5	744.5-750.5	764.5-760.5	794.5-800.5	814.5-820.5
698.5	98	83-113	145-151	155-161	195-201	215-221
	----	683.5-713.5	745.5-751.5	755.5-761.5	795.5-801.5	815.5-821.5
699.5	99	84-114	146-152	156-162	196-202	216-222
	----	684.5-714.5	746.5-752.5	766.5-762.5	796.5-802.5	816.5-822.5
700.5	100	85-115	147-153	157-163	197-203	217-223
	----	685.5-715.5	747.5-763.5	757.5-763.5	797.5-803.5	817.5-823.5
701.5	101	86-116	148-154	158-164	198-204	218-224
	----	686.5-716.5	748.5-764.5	768.5-764.5	798.5-804.5	818.5-824.5
702.5	102	87-117	149-155	159-165	199-205	219-225
	----	687.5-717.5	749.5-766.5	769.5-766.5	799.5-805.5	819.5-825.5
703.5	103	88-118	150-156	160-166	200-206	220-226
	----	688.5-718.5	760.5-756.5	760.5-766.5	800.5-806.5	820.5-826.5
704.5	104	89-119	151-157	161-167	201-207	221-227
	----	689.5-719.5	751.5-757.5	761.5-767.5	801.5-807.5	821.5-827.5
705.5	105	90-120	152-158	162-168	202-208	222-228
	----	690.5-720.5	762.5-758.5	762.5-768.5	802.5-808.5	822.5-828.5
706.5	106	91-121	153-159	163-169	203-209	223-229
	----	691.5-721.5	763.5-769.5	763.5-769.5	803.5-809.5	823.5-829.5
707.5	107	92-122	154-160	164-170	204-210	224-230
	----	692.5-722.5	764.5-760.5	764.5-770.5	804.5-810.5	824.5-830.5
708.5	108	93-123	155-161	165-171	205-211	225-231
	----	693.5-723.5	755.5-761.5	765.5-771.5	805.5-811.5	825.5-831.5
709.5	109	94-124	156-162	166-172	206-212	226-232
	----	694.5-724.5	756.5-762.5	766.5-772.5	806.5-812.5	826.5-832.5
710.5	110	95-125	157-163	167-173	207-213	227-233
	----	696.5-726.5	757.5-763.5	767.5-773.5	807.5-813.5	827.5-833.5
711.5	111	96-126	158-164	168-174	208-214	228-234
	----	696.5-726.5	758.5-764.5	768.5-774.5	808.5-814.5	828.5-834.5
712.5	112	97-127	159-165	169-175	209-215	229-235
	----	697.5-727.5	769.5-766.5	769.5-775.5	809.5-815.5	829.5-835.5

AGO 10032A

Low -band transmitter		Receiver channel/frequency				
Frequency	Channel	Required separation				
		-15 to +15	+50 (±3)	+60 (±3)	+100 (±3)	+120 (±3)
	113	98-128	160-166	170-176	210-216	230-236
713.5	----	698.5-728.5	760.5-766.5	770.5-776.5	810.5-816.5	830.5-836.5
	114	99-129	161-167	171-177	211-217	231-237
714.5	----	699.5-729.5	761.5-767.5	771.5-777.5	811.5-817.5	831.5-837.5
	115	100-130	162-168	172-178	212-218	232-238
715.5	----	700.5-730.5	762.5-768.5	772.5-778.5	812.5-818.5	832.5-838.5
	116	101-131	163-169	173-179	213-219	233-239
716.5	----	701.5-731.5	763.5-769.5	773.5-779.5	813.5-819.5	833.5-839.5
	117	102-132	164-170	174-180	214-220	234-240
717.5	-----	702.5-732.5	764.5-770.5	774.5-780.5	814.5-820.5	834.5-840.5
	118	108-133	166-171	175-181	215-221	235-241
718.5	----	703.5-733.5	765.5-771.5	775.5-781.5	815.5-821.5	835.5-841.5
	119	104-134	166-172	176-182	216-222	236-242
719.5	----	704.5-734.5	766.5-772.5	776.5-782.5	816.5-822.5	836.5-842.5
	120	105-136	167-173	177-183	217-223	237-243
720.5	-----	705.5-735.5	767.5-773.5	777.5-783.5	817.5-823.5	837.5-843.5
	121	106-136	168-174	178-184	218-224	238-244
721.5	----	706.5-736.5	768.5-774.5	778.5-784.5	818.5-824.5	838.5-844.5
	122	107-187	169-176	179-185	219-225	239-245
722.5	----	707.5-737.5	769.5-775.5	779.5-785.5	819.5-826.5	839.5-846.5
	123	108-188	170-176	180-186	220-226	240-246
723.5	----	708.5-738.5	770.5-776.5	780.5-786.5	820.5-826.5	840.5-846.5
	124	109-139	171-177	181-187	221-227	241-247
724.5	----	709.5-739.5	771.5-777.5	781.5-787.5	821.5-827.5	841.5-847.5
	125	110-140	172-178	182-188	222-228	242-248
725.5	----	710.5-740.5	772.5-778.5	782.5-788.5	822.5-828.5	842.5-848.5
	126	111-141	173-179	183-189	223-229	243-249
726.5	----	711.5-741.5	773.5-779.5	783.5-789.5	823.5-829.5	843.5-849.5
	127	112-142	174-180	184-190	224-230	244-250
727.5	----	712.5-742.5	774.5-780.5	784.5-790.5	824.5-830.5	844.5-860.5
	128	113-143	175-181	185-191	226-231	245-251
728.5	----	713.5-743.5	776.5-781.5	786.5-791.5	826.5-831.5	845.5-861.5
	129	114-144	176-182	186-192	226-232	246-252
729.5	----	714.5-744.5	776.5-782.5	786.5-792.5	826.5-832.5	846.5-852.5
	130	115-146	177-183	187-193	227-233	247-253
730.5	----	715.5-745.5	777.5-783.5	787.5-793.5	827.5-833.5	847.5-853.5
	131	116-146	178-184	188-194	228-234	248-254
731.5	----	716.5-746.5	778.5-784.5	788.5-794.5	828.5-834.5	848.5-854.5
	132	117-147	179-185	189-195	229-235	249-255
732.5	----	717.5-747.5	779.5-786.5	789.5-795.5	829.5-835.5	849.5-855.5
	133	118-148	180-186	190-196	230-236	250-256
733.5	----	718.5-748.5	780.5-786.5	790.5-796.5	830.5-836.5	850.5-856.5
	134	119-149	181-187	191-197	231-237	251-257
734.5	----	719.5-749.5	781.5-787.5	791.5-797.5	831.5-837.5	851.5-857.5
	135	120-160	182-188	192-198	232-238	252-258
735.5	----	720.5-760.5	782.5-788.5	792.5-798.5	832.5-838.5	852.5-858.5
	136	121-161	183-189	193-199	233-239	253-259
736.5	----	721.5-751.5	783.5-789.5	793.5-799.5	833.5-839.5	853.5-859.5
	137	122-162	184-190	194-200	234-240	254-260
737.5	----	722.5-752.5	784.5-790.5	794.5-800.5	834.5-840.5	854.5 860.5
	138	128-163	186-191	195-201	236-241	265-261
738.5	----	723.5-763.5	786.5-791.5	796.5-801.5	836.5-841.5	865.5-861.5
	139	124-164	186-192	196-202	236-242	256-262
739.5	----	724.5-754.5	786.5-792.5	796.5-802.5	836.5-842.5	856.5-862.5

AGO 10032A

Low -band transmitter		Receiver channel/frequency				
Frequency	Channel	Required separation				
		-15 to +15	+50 (±3)	+60 (±3)	+100 (±3)	+120 (±3)
740.5	140	125-155	187-193	197-203	237-243	257-263
	----	725.5-755.5	787.5-793.5	797.5-803.5	837.5-843.5	857.5-863.5
	141	126-156	188-194	198-204	238-244	258-264
741.5	----	726.5-756.5	788.5-794.5	798.5-804.5	838.5-844.5	858.5-864.5
	142	127-157	189-195	199-205	239-245	259-265
742.5	----	727.5-767.5	789.5-795.5	799.5-805.5	839.5-845.5	859.5-865.5
	143	128-158	190-196	200-206	240-246	260-266
743.5	----	728.5-758.5	790.5-796.5	800.5-806.5	840.5-846.5	860.5-866.5
	144	129-159	191-197	201-207	241-247	261-267
744.5	----	729.5-759.5	791.5-797.5	801.5-807.5	841.5-847.5	861.5-867.5
	145	130-160	192-198	202-208	242-248	262-268
745.5	----	730.5-760.5	792.5-798.5	802.5-808.5	842.5-848.5	862.5-868.5
	146	131-161	193-199	203-209	243-249	263-269
746.5	----	731.5-761.5	793.5-799.5	803.5-809.5	843.5-849.5	863.5-869.5
	147	132-162	194-200	204-210	244-250	264-270
747.5	----	732.5-762.5	794.5-800.5	804.5-810.5	844.5-850.5	864.5-870.5
	148	133-163	195-201	205-211	245-251	265-271
748.5	----	733.5-763.5	795.5-801.5	805.5-811.5	845.5-851.5	865.5-871.5
	149	134-164	196-202	206-212	246-252	266-272
749.5	----	734.5-764.5	796.5-802.5	806.5-812.5	846.5-852.5	866.5-872.5
	150	135-165	197-203	207-213	247-253	267-273
750.5	----	735.5-765.5	797.5-803.5	807.5-813.5	847.5-853.5	867.5-873.5
	151	136-166	198-204	208-214	248-254	268-274
751.5	----	736.5-766.5	798.5-804.5	808.5-814.5	848.5-854.5	868.5-874.5
	152	137-167	199-205	209-215	249-255	269-275
752.5	----	737.5-767.5	799.5-805.5	809.5-815.5	849.5-855.5	869.5-875.5
	153	138-168	200-206	210-216	250-256	270-276
753.5	----	738.5-768.5	800.5-806.5	810.5-816.5	850.5-856.5	870.5-876.5
	154	139-169	201-207	211-217	251-257	271-277
754.5	----	739.5-769.5	801.5-807.5	811.5-817.5	851.5-857.5	871.5-877.5
	155	140-170	202-208	212-218	252-258	272-278
755.5	----	740.5-770.5	802.5-808.5	812.5-818.5	852.5-858.5	872.5-878.5
	156	141-171	203-209	213-219	253-259	273-279
756.5	----	741.5-771.5	803.5-809.5	813.5-819.5	853.5-859.5	873.5-879.5
	157	142-172	204-210	214-220	254-260	274-280
757.5	----	742.5-772.5	804.5-810.5	814.5-820.5	854.5-860.5	874.5-880.5
	158	143-173	205-211	215-221	255-261	275-281
758.5	----	743.5-773.5	805.5-811.5	815.5-821.5	855.5-861.5	875.5-881.5
	159	144-174	206-212	216-222	256-262	276-282
759.5	----	744.5-774.5	806.5-812.5	816.5-822.5	856.5-862.5	876.5-882.5
	160	145-175	207-213	217-223	257-263	277-283
760.5	----	745.5-775.5	807.5-813.5	817.5-823.5	857.5-863.5	877.5-883.5
	161	146-176	208-214	218-224	258-264	278-284
761.5	----	746.5-776.5	808.5-814.5	818.5-824.5	858.5-864.5	878.5-884.5
	162	147-177	209-215	219-225	259-265	279-285
762.5	----	747.5-777.5	809.5-815.5	819.5-825.5	859.5-865.5	879.5-885.5
	163	148-178	210-216	220-226	260-266	280-286
763.5	----	748.5-778.5	810.5-816.5	820.5-826.5	860.5-866.5	880.5-886.5
	164	149-179	211-217	221-227	261-267	281-287
764.5	----	749.5-779.5	811.5-817.5	821.5-827.5	861.5-867.5	881.5-887.5
	165	150-180	212-218	222-228	262-268	282-288
765.5	----	750.5-780.5	812.5-818.5	822.5-828.5	862.5-868.5	882.5-888.5
	166	151-181	213-219	223-229	263-269	283-289
766.5	----	751.5-781.5	813.5-819.5	823.5-829.5	863.5-869.5	883.5-889.5

AGO 10032A

Low -band transmitter		Receiver channel/frequency				
Frequency	Channel	Required separation				
		-15 to +15	+50 (±3)	+60 (±3)	+100 (±3)	+120 (±3)
767.5	167	152-182	214-220	224-230	264-270	284-290
	----	752.5-782.5	814.5-820.5	824.5-830.5	864.5-870.5	884.5-890.5
	168	153-183	215-221	225-231	265-271	285-291
768.5	----	753.5-783.5	815.5-821.5	825.5-831.5	865.5-871.5	885.5-891.5
	169	154-184	216-222	226-232	266-272	286-292
769.5	----	764.5-784.5	816.5-822.5	826.5-832.5	866.5-872.5	886.5-892.5
	170	155-185	217-223	227-233	267-273	287-293
770.5	----	755.5-785.5	817.5-823.5	827.5-833.5	867.5-873.5	887.5-893.5
	171	156-186	218-224	228-234	268-274	288-294
771.5	----	766.5-786.5	818.5-824.5	828.5-834.5	868.5-874.5	888.5-894.5
	172	157-187	219-225	229-236	269-275	289-296
772.5	----	757.5-787.5	819.5-825.5	829.5-835.5	869.5-876.5	889.5-896.5
	173	158-188	220,-226	230-236	270-276	290-296
773.5	----	758.5-788.5	820.5-826.5	830.5-836.5	870.5-876.5	890.5-896.5
	174	159-189	221-227	231-237	271-277	291-297
774.5	----	769.5-789.5	821.5-827.5	831.5-837.5	871.5-877.5	891.5-897.5
	175	160-190	222-228	232-288	272-278	292-298
775.5	----	760.5-790.5	822.5-828.5	832.5-888.5	872.5-878.5	892.5-898.5
	176	161-191	223-229	283-239	273-279	293-299
776.5	----	761.5-791.5	823.5-829.5	883.5-839.5	873.5-879.5	893.5-899.5
	177	162-192	224-230	284-240	274-280	294-300
777.5	----	762.5-792.5	824.5-830.5	884.5-840.5	874.5-880.5	894.5-900.5
	178	163-193	225-231	235-241	275-281	295-301
778.5	----	763.5-793.5	826.5-831.5	835.5-841.5	875.5-881.5	896.5-901.5
	179	164-194	226-232	236-242	276-282	296-%02
779.5	----	764.5-794.5	826.5-832.5	836.5-842.5	876.5-882.5	896.5-902.5
	180	165-195	227-233	237-243	277-283	297-303
780.5	----	765.5-795.5	827.5-833.5	837.5-843.5	877.5-883.5	897.5-903.5
	181	166-196	228-234	238-244	278-284	298-304
781.5	----	766.5-796.5	828.5-834.5	838.5-844.5	878.5-884.5	898.5-904.5
	182	167-197	229-236	239-245	279-285	299-305
782.5	----	767.5-797.5	829.5-836.5	839.5-845.5	879.5-885.5	899.5-905.5
	183	168-198	230-236	240-246	280-286	300-306
783.5	----	768.5-798.5	830.5-836.5	840.5-846.5	880.5-886.5	900.5-906.5
	184	169-199	231-237	241-247	281-287	301-307
784.5	----	769.5-799.5	831.5-837.5	841.5-847.5	881.5-887.5	901.5-907.5
	185	170-200	232-238	242-248	282-288	302-308
785.5	----	770.5-800.5	832.5-838.5	842.5-848.5	882.5-888.5	902.5-908.5
	186	171-201	233-239	243-249	283-289	303-309
786.5	----	771.5-801.5	833.5-839.5	843.5-849.5	883.5-889.5	903.5-909.5
	187	172-202	234-240	244-250	284-290	304-310
787.5	----	772.5-802.5	834.5-840.5	844.5-850.5	884.5-890.5	904.5-910.5
	188	173-203	235-241	245-251	285-291	305-311
788.5	----	773.5-803.5	835.5-841.5	845.5-851.5	885.5-891.5	905.5-911.5
	189	174-204	236-242	246-252	286-292	306-312
789.5	----	774.5-804.5	836.5-842.5	846.5-852.5	X86.5-892.5	906.5-912.5
	190	175-205	237-243	247-253	287-293	307-313
790.5	----	776.5-805.5	837.5-843.5	847.5-853.5	887.5-893.5	907.5-913.5
	191	176-206	238-244	248-264	288-294	308-314
791.5	----	776.5-806.5	838.5-844.5	848.5-864.5	888.5-894.5	908.5-914.5
	192	177-207	239-245	249-265	289-295	309-316
792.5	----	777.5-807.5	839.5-845.5	849.5-855.5	889.5-896.5	909.5-915.5
	193	178-208	240-246	260-266	290-296	310-316
793.5	----	778.5-808.5	840.5-846.5	860.5-866.5	890.5-896.5	910.5-916.5

AGO 10032A

Low -band transmitter		Receiver channel/frequency				
Frequency	Channel	Required separation				
		-15 to +15	+50 (±3)	+60 (±3)	+100 (±3)	+120 (±3)
	194	179-209	241-247	251-257	291-297	311-317
794.5	----	779.5-809.5	841.5-847.5	851.5-857.5	891.5-897.5	911.5-917.5
	195	180-210	242-248	262-268	292-298	312-318
795.5	----	780.5-810.5	842.5-848.5	852.5-858.5	892.5-898.5	912.5-918.5
	196	181-211	243-249	253-259	293-299	313-319
796.5	----	781.5-811.5	843.5-849.5	863.5-859.5	893.5-899.5	913.5-919.5
	197	182-212	244-260	264-260	294-300	314-320
797.5	----	782.5-812.5	844.5-860.5	864.5-860.5	894.5-900.5	914.5-920.5
	198	183-213	245-251	255-261	295-301	315-321
798.5	----	783.5-813.5	845.5-851.5	855.5-861.5	895.5-901.5	915.5-921.5
	199	184-214	246-252	256-262	296-302	316-322
799.5	----	784.5-814.5	846.5-852.5	856.5-862.5	896.5-902.5	916.5-922.5
	200	185-215	247-253	257-263	297-303	317-323
800.5	----	785.5-815.5	847.5-853.5	857.5-863.5	897.5-903.5	917.5-923.5
	201	186-216	248-254	258-264	298-304	318-324
801.5	----	786.5-816.5	848.5-854.5	858.5-864.5	898.5-904.5	918.5-924.5
	202	187-217	249-255	259-265	299-305	319-326
802.5	----	787.5-817.5	849.5-855.5	859.5-865.5	899.5-905.5	919.5-925.5
	203	188-218	250-256	260-266	300-306	320-326
803.5	----	788.5-818.5	850.5-856.5	860.5-866.5	900.5-906.5	920.5-926.5
	204	189-219	251-257	261-267	301-307	321-327
804.5	----	789.5-819.5	851.5-857.5	861.5-867.5	901.5-907.5	921.5-927.5
	205	190-220	252-258	262-268	302-308	322-328
805.5	----	790.5-820.5	852.5-858.5	862.5-868.5	902.5-908.5	922.5-928.5
	206	191-221	253-259	263-269	303-309	323-329
806.5	----	791.5-821.5	853.5-859.5	863.5-869.5	903.5-909.5	923.5-929.5
	207	192-222	254-260	264-270	304-310	324-330
807.5	----	792.5-822.5	854.5-860.5	864.5-870.5	904.5-910.5	924.5-930.5
	208	193-223	255-261	265-271	305-311	325-331
808.5	----	793.5-823.5	855.5-861.5	865.5-871.5	905.5-911.5	926.5-931.5
	209	194-224	256-262	266-272	306-312	326-332
809.5	----	794.5-824.5	866.5-862.5	866.5-872.5	906.5-912.5	926.5-932.5
	210	195-225	257-263	267-273	307-313	327-333
810.5	----	795.5-825.5	857.5-863.5	867.5-873.5	907.5-913.5	927.5-933.5
	211	196-226	258-264	268-274	308-314	328-334
811.5	----	796.5-826.5	858.5-864.5	868.5-874.5	908.5-914.5	928.5-934.5
	212	197-227	259-265	269-275	309-315	329-335
812.5	----	797.5-827.5	859.5-865.5	869.5-875.5	909.5-915.5	929.5-935.5
	213	198-228	260-266	270-276	310-316	330-336
813.5	----	798.5-828.5	860.5-866.5	870.5-876.5	910.5-916.5	930.5-936.5
	214	199-229	261-267	271-277	311-317	331-337
814.5	----	799.5-829.5	861.5-867.5	871.5-877.5	911.5-917.5	931.5-937.5
	215	200-230	262-268	272-278	312-318	332-338
815.5	----	800.5-830.5	862.5-868.5	872.5-878.5	912.5-918.5	932.5-938.5
	216	201-231	263-269	273-279	313-319	333-339
816.5	----	801.5-831.5	863.5-869.5	873.5-879.5	913.5-919.5	933.5-939.5
	217	202-232	264-270	274-280	314-320	334-340
817.5	----	802.5-832.5	864.5-870.5	874.5-880.5	914.5-920.5	934.5-940.5
	218	203-233	265-271	275-281	315-321	335-341
818.5	----	803.5-833.5	865.5-871.5	875.5-881.5	915.5-921.5	935.5-941.5
	219	204-234	266-272	276-282	316-322	336-342
819.5	----	804.5-834.5	866.5-872.5	876.5-882.5	916.5-922.5	936.5-942.5
	220	205-235	267-273	277-283	317-323	337-343
820.5	----	805.5-835.5	867.5-873.5	877.5-883.5	917.5-923.5	937.5-943.5

AGO 10032A

Low -band transmitter		Receiver channel/frequency				
Frequency	Channel	Required separation				
		-15 to +15	+50 (±3)	+60 (±3)	+100 (±3)	+120 (±3)
821.5	221	206-236	268-274	278-284	318-324	338-344
	-----	806.5-836.5	868.5-874.5	878.5-884.5	918.5-924.5	938.5-944.5
	222	207-237	269-275	279-285	319-325	339-345
822.5	-----	807.5-837.5	869.5-875.5	879.5-885.5	919.5-926.5	939.5-946.5
	223	208-238	270-276	280-286	320-326	340-346
823.5	-----	808.5-838.5	870.5-876.5	880.5-886.5	920.5-926.5	940.5-946.5
	224	209-239	271-277	281-287	321-327	341-347
824.5	-----	809.5-839.5	871.5-877.5	881.5-887.5	921.5-927.5	941.5-947.5
	225	210-240	272-278	282-288	322-328	342-348
826.5	-----	810.5-840.5	872.5-878.5	882.5-888.5	922.5-928.5	942.5-948.5
	226	211-241	273-279	283-289	323-329	343-349
826.5	-----	811.5-841.5	873.5-879.5	883.5-889.5	923.5-929.5	943.5-949.5
	227	212-242	274-280	284-290	324-330	344-350
827.5	-----	812.5-842.5	874.5-880.5	884.5-890.5	924.5-930.5	944.5-960.5
	228	213-243	275-281	285-291	325-331	345-351
828.5	-----	813.5-843.5	875.5-881.5	886.5-891.5	925.5-931.5	946.5-961.5
	229	214-244	276-282	286-292	326-332	346-362
829.5	-----	814.5-844.5	876.5-882.5	886.5-892.5	926.5-932.5	946.5-952.5
	230	216-246	277-283	287-293	327-333	347-353
830.5	-----	816.5-846.5	877.5-883.5	887.5-893.5	927.5-933.5	947.5-953.5
	231	216-246	278-284	288-294	328-334	348-364
831.5	-----	816.5-846.5	878.5-884.5	888.5-894.5	928.5-934.5	948.5-964.5
	232	217-247	279-286	289-296	329-335	349-355
832.5	-----	817.5-847.5	879.5-885.5	889.5-896.5	929.5-935.5	949.5-956.5
	233	218-248	280-286	290-296	330-336	360-356
833.5	-----	818.5-848.5	880.5-886.5	890.5-896.5	930.5-936.5	960.5-956.5
	234	219-249	281-287	291-297	331-337	351-357
834.5	-----	819.5-849.5	881.5-887.5	891.5-897.5	931.5-937.5	951.5-957.5
	285	220-260	282-288	292-298	332-338	352-358
835.5	-----	820.5-860.5	882.5-888.5	892.5-898.5	932.5-938.5	952.5-958.5
	236	221-261	288-889	293-299	333-339	363-369
836.5	-----	821.5-851.5	883.5-889.5	893.5-899.5	933.5-939.5	963.5-969.5
	237	222-262	284-890	294-300	334-340	354-360
837.5	-----	822.5-862.5	884.5-890.5	894.5-900.5	934.5-940.5	954.5-960.5
	238	223-253	286-891	295-301	335-341	355-361
838.5	-----	823.5-853.5	886.5-891.5	896.5-901.5	935.5-941.5	966.5-961.5
	239	224-254	286-892	296-302	336-342	366-362
839.5	-----	824.5-854.5	886.5-892.5	896.5-902.5	936.5-942.5	956.5-962.5
	240	225-256	287-293	297-303	337-343	357-363
840.5	-----	826.5-866.5	887.5-893.5	897.5-903.5	937.5-943.5	957.5-963.5
	241	226-256	288-294	298-304	338-344	368-364
841.5	-----	826.5-866.5	888.5-894.5	898.5-904.5	938.5-944.5	968.5-964.5
	242	227-257	289-296	299-305	339-346	359-366
842.5	-----	827.5-857.5	889.5-896.5	899.5-906.5	939.5-945.5	959.5-966.5
	243	228-268	290-296	300-306	340-346	360-366
843.5	-----	828.5-868.5	890.5-896.5	900.5-906.5	940.5-946.5	960.5-966.5
	244	229-269	291-297	301-307	341-347	361-367
844.5	-----	829.5-869.5	891.5-897.5	901.5-907.5	941.5-947.5	961.5-967.5
	245	230-260	292-298	%02-308	342-348	362-368
845.5	-----	830.5-860.5	892.5-898.5	902.5-908.5	942.5-948.5	962.5-968.5
	246	231-261	293-299	303-309	343-349	363-369
846.5	-----	831.5-861.5	893.5-899.5	903.5-909.5	943.5-949.5	963.5-969.5
	247	232-262	294-300	304-310	344-360	364-370
847.5	-----	832.5-862.5	894.5-900.5	904.5-910.5	944.5-960.5	964.5-970.5

AGO 10032A

Low -band transmitter		Receiver channel/frequency				
Frequency	Channel	Required separation				
		-15 to +15	+50 (±3)	+60 (±3)	+100 (±3)	+120 (±3)
848.5	248	233-263	295-301	305-311	345-351	365-371
	-----	833.5-863.5	896.5-901.5	905.5-911.5	945.5-951.5	965.5-971.5
	249	234-264	296-302	306-312	346-352	366-372
849.5	-----	834.5-864.5	896.5-902.5	906.5-912.5	946.5-952.5	966.5-972.5
	250	235-265	297-303	307-313	347-363	367-373
850.5	-----	835.5-865.5	897.5-903.5	907.5-913.5	947.5-953.5	967.5-973.5
	251	236-266	298-304	308-314	348-354	368-374
851.5	-----	836.5-866.5	898.5-904.5	908.5-914.5	948.5-954.5	968.5-974.5
	252	237-267	299-305	309-315	349-355	369-375
852.5	-----	837.5-867.5	899.5-905.5	909.5-915.5	949.5-955.5	969.5-975.5
	253	238-268	300-306	310-316	350-356	370-376
853.5	-----	838.5-868.5	900.5-906.5	910.5-916.5	950.5-966.5	970.5-976.5
	254	239-269	301-307	311-317	351-357	371-377
854.5	-----	839.5-869.5	901.5-907.5	911.5-917.5	951.5-957.5	971.5-977.5
	255	240-270	302-308	312-318	352-358	372-378
855.5	-----	840.5-870.5	902.5-908.5	912.5-918.5	952.5-958.5	972.5-978.5
	256	241-271	303-309	313-319	353-369	373-379
856.5	-----	841.5-871.5	903.5-909.5	913.5-919.5	953.5-959.5	973.5-979.5
	257	242-272	304-310	314-320	354-360	374-380
857.5	-----	842.5-872.5	904.5-910.5	914.5-920.5	954.5-960.5	974.5-980.5
	258	243-273	305-311	315-321	355-361	375-381
858.5	-----	843.5-873.5	905.5-911.5	915.5-921.5	955.5-961.5	975.5-981.5
	259	244-274	306-312	316-322	356-362	376-382
859.5	-----	844.5-874.5	906.5-912.5	916.5-922.5	956.5-962.5	976.5-982.5
	260	245-275	307-313	317-323	357-363	377-383
860.5	-----	845.5-875.5	907.5-913.5	917.5-923.5	957.5-963.5	977.5-983.5
	261	246-276	308-314	318-324	358-364	378-384
861.5	-----	846.5-876.5	908.5-914.5	918.5-924.5	958.5-964.5	978.5-984.5
	262	247-277	309-315	319-325	359-365	379-385
862.5	-----	847.5-877.5	909.5-915.5	919.5-925.5	959.5-965.5	979.5-985.5
	263	248-278	310-316	320-326	360-366	380-386
863.5	-----	848.5-878.5	910.5-916.5	920.5-926.5	960.5-966.5	980.5-986.5
	264	249-279	311-317	321-327	361-367	381-387
864.5	-----	849.5-879.5	911.5-917.5	921.5-927.5	961.5-967.5	981.5-987.5
	265	250-280	312-318	322-328	362-368	382-388
865.5	-----	850.5-880.5	912.5-918.5	922.5-928.5	962.5-968.5	982.5-988.5
	266	251-281	313-319	323-329	363-369	383-389
866.5	-----	851.5-881.5	913.5-919.5	923.5-929.5	963.5-969.5	983.5-989.5
	267	252-282	314-320	324-330	364-370	384-390
867.5	-----	852.5-882.5	914.5-920.5	924.5-930.5	964.5-970.5	984.5-990.5
	268	253-283	315-321	325-331	365-371	385-391
868.5	-----	853.5-883.5	915.5-921.5	925.5-931.5	965.5-971.5	985.5-991.5
	269	254-284	316-322	326-332	366-372	386-392
869.5	-----	854.5-884.5	916.5-922.5	926.5-932.5	966.5-972.5	986.5-992.5
	270	255-285	317-323	327-333	367-373	387-393
870.5	-----	855.5-885.5	917.5-923.5	927.5-933.5	967.5-973.5	987.5-993.5
	271	256-286	318-324	328-334	368-374	388-394
871.5	-----	856.5-886.5	918.5-924.5	928.5-934.5	968.5-974.5	988.5-994.5
	272	257-287	319-325	329-336	369-375	389-395
872.5	-----	857.5-887.5	919.5-925.5	929.5-935.5	969.5-975.5	989.5-995.5
	273	258-288	320-326	330-336	370-376	390-396
873.5	-----	858.5-888.5	920.5-926.5	930.5-936.5	970.5-976.5	990.5-996.5
	274	259-289	321-327	331-337	371-377	391-397
874.5	-----	859.5-889.5	921.5-927.5	931.5-937.5	971.5-977.5	991.5-997.5

AGO 10032A

Low -band transmitter		Receiver channel/frequency				
Frequency	Channel	Required separation				
		-15 to +15	+50 (±3)	+60 (±3)	+100 (±3)	+120 (±3)
	275	260-290	322-328	332-338	372-378	392-398
875.5	----	860.5-890.5	922.5-928.5	932.5-938.5	972.5-978.5	992.5-998.5
	276	261-291	323-329	333-339	373-379	393-399
876.5	----	861.5-891.5	923.5-929.5	933.5-939.5	973.5-979.5	993.5-999.5
	277	262-292	324-330	334-340	374-380	394-399
877.5	----	862.5-892.5	924.5-930.5	934.5-940.5	974.5-980.5	994.5-999.5
	278	263-293	325-331	335-341	375-381	395-399
878.5	----	863.5-893.5	926.5-931.5	935.5-941.5	975.5-981.5	995.5-999.5
	279	264-294	326-332	336-342	376-382	396-399
879.5	----	864.5-894.5	926.5-932.5	936.5-942.5	976.5-982.5	996.5-999.5
	280	265-295	327-333	337-343	377-383	397-399
880.5	----	865.5-895.5	927.5-933.5	937.5-943.4	977.5-983.5	997.5-999.5
	281	266-290	328-334	338-344	378-384	398-399
881.5	----	866.5-896.5	928.5-934.5	938.5-944.5	978.5-984.5	998.5-999.5
	282	267-297	329-335	339-346	379-385	-399
882.5	----	867.5-897.5	929.5-936.5	939.5-945.5	979.5-985.5	-999.5
	283	268-298	330-336	340-346	380-386	
883.5	----	868.5-898.5	930.5-936.5	940.5-946.5	980.5-986.5	
	284	269-299	331-337	341-347	381-387	
884.5	----	869.5-899.5	931.5-937.5	941.5-947.5	981.5-987.5	
	285	270-300	332-338	342-348	382-388	
885.5	----	870.5-900.5	932.5-938.5	942.5-948.4	982.5-988.5	
	286	271-301	333-339	343-349	383-389	
886.5	----	871.5-901.5	933.5-939.5	943.5-949.5	983.5-989.5	
	287	272-302	334-340	344-350	384-390	
887.5	----	872.5-902.5	934.5-940.5	944.5-950.5	984.5-990.5	
	288	273-303	335-341	345-351	385-391	
888.5	----	873.5-903.5	935.5-941.5	945.5-951.5	985.5-991.5	
	289	274-304	336-342	346-352	386-392	
889.5	----	874.5-904.5	936.5-942.5	946.5-952.5	986.5-992.5	
	290	275-305	337-343	347-353	387-393	
890.5	----	875.5-905.5	937.5-943.5	947.5-953.5	987.5-993.5	
	291	276-306	338-344	348-354	388-394	
891.5	----	876.5-906.5	938.5-944.5	948.5-954.5	988.5-994.5	
	292	277-307	339-345	349-355	389-395	
892.5	----	877.5-907.5	939.5-945.5	949.5-955.5	989.5-995.5	
	293	278-308	340-346	350-356	390-396	
893.5	----	878.5-908.5	940.5-946.5	950.5-956.5	990.5-996.5	
	294	279-309	341-347	351-357	391-397	
894.5	----	879.5-909.5	941.5-947.5	951.5-957.5	991.5-997.5	
	295	280-310	342-348	352-358	392-398	
895.5	----	880.5-910.5	942.5-948.5	952.5-958.5	992.5-998.5	
	296	281-311	343-349	353-359	393-399	
896.5	----	881-6-911-5	943.5-949.5	953.5-959.5	993.5-999.5	
	297	282-312	344-350	354-360	394-399	
897.5	----	882.5-912.5	944.5-950.5	954.5-960.5	994.5-999.5	
	298	283-313	3,45-351	355-361	395-399	
898.5	----	883.5-913.5	945.5-951.5	955.5-961.5	995.5-999.5	
	299	284-314	346-352	356-362	396-399	
899.5	----	884.5-914.5	946.5-952.5	956.5-962.5	996.5-999.5	
	300	286-316	347-353	357-363	397-399	
900.5	----	885.5-915.5	947.5-953.5	957.5-963.5	997.5-999.5	
	301	286-316	348-354	358-364	398-399	
901.5	----	886.5-916.5	948.5-954.5	958.5-964.5	998.5-999.5	

AGO 10032A

Low -band transmitter		Receiver channel/frequency				
Frequency	Channel	Required separation				
		-15 to +15	+50 (±3)	+60 (±3)	+100 (±3)	+120 (±3)
902.5	302	287-317	349-355	359-365	-399 -999.5	
	----	887.5-917.5	949.5-955.5	959.5-965.5		
903.5	303	288-318	350-356	360-366		
	----	888.5-918.5	950.5-956.5	960.5-966.5		
904.5	304	289-319	351-357	361-367		
	----	889.5-919.5	951.5-957.5	961.5-967.5		
905.5	305	290-320	352-358	362-368		
	----	890.5-920.5	952.5-958.5	962.5-968.5		
906.5	306	291-321	323-359	363-369		
	----	891.5-921.5	953.5-959.5	963.5-969.5		
907.5	307	292-322	354-360	364-370		
	----	892.5-922.5	954.5-960.5	964.5-970.5		
908.5	308	293-323	355-361	365-371		
	----	893.5-923.5	955.5-961.5	965.5-971.5		
909.5	309	294-324	356-362	366-372		
	----	894.5-924.5	956.5-962.5	966.5-972.5		
910.5	310	295-325	357-363	367-373		
	----	895.5-925.5	957.5-963.5	967.5-973.5		
911.5	311	296-326	358-364	368-374		
	----	896.5-926.5	958.5-964.5	968.5-974.5		
912.5	312	297-327	359-365	369-375		
	----	897.5-927.5	959.5-965.5	969.5-975.5		
913.5	313	298-328	360-366	370-376		
	----	898.5-928.5	960.5-966.5	970.5-976.5		
914.5	314	299-329	361-367	371-377		
	----	899.5-929.5	961.5-967.5	971.5-977.5		
915.5	315	300-330	362-368	372-378		
	----	900.5-930.5	962.5-968.5	972.5-978.5		
916.5	316	301-331	363-369	373-379		
	----	901.5-931.5	963.5-969.5	973.5-979.5		
917.5	317	302-332	364-370	374-380		
	----	902.5-932.5	964.5-970.5	974.5-980.5		
918.5	318	303-333	365-371	375-381		
	----	903.5-933.5	965.5-971.5	975.5-981.5		
919.5	319	304-334	366-372	376-382		
	----	904.5-934.5	966.5-972.5	976.5-982.5		
920.5	320	305-335	367-373	377-383		
	----	905.5-935.5	967.5-973.5	977.5-983.5		
921.5	321	306-336	368-374	378-384		
	----	906.5-936.5	968.5-974.5	978.5-984.5		
922.5	322	307-337	369-375	379-385		
	----	907.5-937.5	979.5-985.5	979.5-985.5		
923.5	323	308-338	370-376	380-386		
	----	908.5-938.5	970.5-976.5	980.5-986.5		
924.5	324	309-339	371-377	381-387		
	----	909.5-939.5	971.5-977.5	981.5-987.5		
925.5	325	310-340	372-378	383-388		
	----	910.5-940.5	972.5-978.5	982.5-988.5		
926.5	326	311-341	373-379	383-389		
	----	911.5-941.5	973.5-979.5	983.5-989.5		
927.5	327	312-342	374-380	384-390		
	----	912.5-942.5	974.5-980.5	984.5-990.5		
928.5	328	313-343	375-381	385-391		
	----	913.5-943.5	976.5-981.5	985.5-991.5		

AGO 10032A

Low -band transmitter		Receiver channel/frequency				
Frequency	Channel	Required separation				
		-15 to +15	+50 (±3)	+60 (±3)	+100 (±3)	+120 (±3)
929.5	329	314-344	376-382	386-392		
	----	914.5-944.5	976.5-982.5	986.5-992.5		
	330	315-345	377-383	387-393		
930.5	----	915.5-945.5	977.5-983.5	987.5-993.5		
	331	316-346	378-384	388-394		
931.5	----	916.5-946.5	978.5-984.5	988.5-994.5		
	332	317-347	379-385	389-395		
932.5	----	917.5-947.5	979.5-985.5	989.5-995.5		
	333	318-348	380-386	390-396		
938.5	----	918.5-948.5	980.5-986.5	990.5-996.5		
	334	319-349	381-387	391-397		
934.5	----	919-949.5	981.5-987.5	991.5-997.5		
	335	320-350	382-388	392-398		
836.5	-----	920.5-950.5	982.5-988.5	992.5-998.5		
	336	321-351	383-389	398-399		
936.5	-----	921.5-951.5	983.5-989.5	993.5-999.5		
	337	322-352	384-390	394-399		
937.5	-----	922.5-952.5	984.5-990.5	994.5-999.5		
	338	323-363	385-391	395-399		
938.5	-----	923.5-953.5	985.5-991.5	995.5-999.5		
	339	824-354	386-392	396-899		
939.5	----	924.5-964.5	986.5-992.5	996.5-999.5		
	340	325-366	387-393	397-399		
940.5	----	926.5-955.5	987.5-993.5	997.5-999.5		
	341	826-356	388-394	398-399		
941.5	----	926.5-956.5	988.5-994.5	998.5-999.5		
	342	327-367	389-395	-399		
942.5	-----	927.5-957.5	989.5-995.5	-999.5		
	343	328-358	390-896-			
943.5	-----	928.5-968.5	990.5-996.5			
	344	329-359	391-397			
944.5	-----	929.5-959.5	991.5-997.5			
	345	380-360	392-398			
945.5	-----	980.5-960.5	992.5-998.5			
	346	331-361	398-399			
946.5	-----	931.5-961.5	998.5-999.5			
	347	332-362	394-899			
947.5	-----	932.5-962.5	994.5-999.5			
	348	333-363	396-399			
948.5	-----	933.5-968.5	995.5-999.5			
	349	334-364	396-399			
949.5	-----	934.5-964.5	996.5-999.5			
	350	885-866	397-899			
950.5	-----	936.5-966.5	997.5-999.5			
	351	836-366	898-899			
951.5	----	986.5-966.5	998.5-999.5			
	352	887-367	-899			
952.5	----	937.5-967.5	- 999.5			
	353	338-368				
953.5	----	938.5-968.5				
	354	339-369				
954.5	-----	939.5-969.5				
	355	840-370				
955.5	----	940.5-970.5				

AGO 10032A

Low -band transmitter		Receiver channel/frequency				
Frequency	Channel	Required separation				
		-15 to +15	+50 (±3)	+60 (±3)	+100 (±3)	+120 (±3)
956.5	356	341- 371				
	-----	941.5-971.5				
957.5	357	342-372				
	-----	942.5-972.5				
958.5	358	343-373				
	-----	943.5-973.5				
959.5	359	344-374				
	-----	944.5-974.5				
960.5	360	345-375				
	-----	945.5-975.5				
961.5	361	346-376				
	-----	946.5-976.5				
962.5	362	347-377				
	-----	947.5-977.5				
963.5	363	948-878				
	-----	948.5-978.5				
964.5	364	349-379				
	-----	949.5-979.5				
965.5	365	350-380				
	-----	960.5-980.5				
966.5	366	351-381				
	-----	951.5-981.5				
967.5	367	352-382				
	-----	962.5-982.5				
968.5	368	353-383				
	-----	953.5-983.5				
969.5	369	364-384				
	-----	964.5-984.5				
970.5	370	865-886				
	-----	955.5-985.5				
971.5	371	356-386				
	-----	966.5-986.5				
972.5	372	357-887				
	-----	975.5-987.5				
973.5	373	358-388				
	-----	968.5-988.5				
974.5	374	869-389				
	-----	969.5-989.5				
975.5	375	360-890				
	-----	960.5-990.5				
976.5	376	361-391				
	-----	961.5-991.5				
977.5	377	862-892				
	-----	962.5-992.5				
978.5	378	363-893				
	-----	968.5-993.5				
979.5	379	864-394				
	-----	964.5-994.5				
980.5	380	866-895				
	-----	965.5-995.5				
981.5	381	366-396				
	-----	966.5-996.5				
982.5	382	367-397				
	-----	967.5-997.5				

AGO 10032A

Low-band transmitter		Receiver channel/frequency				
Frequency	Channel	Required separation				
		-15 to +15	+50 (±3)	+60 (±3)	+100 (±3)	+120 (±3)
	383	368-398				
983.5	----	968.5-998.5				
	384	369-399				
984.5	----	969.5-999.5				
	385	370-399				
985.5	----	970.5-999.5				
	386	371-399				
986.5	----	971.5-999.5				
	387	872-399				
987.5	----	972.5-999.5				
	388	873-899				
988.5	----	973.5-999.5				
	389	374-399				
989.5	----	974.5-999.5				
	390	376-399				
990.5	----	975.5-999.5				
	391	376-399				
991.5	----	976.5-999.5				
	392	377-399				
992.5	----	977.5-999.5				
	393	378-399				
993.5	----	978.5-999.5				
	394	379-399				
994.5	----	979.5-999.5				
	395	380-399				
995.5	----	980.5-999.5				
	396	381-399				
996.5	----	981.5-999.5				
	397	382-399				
997.5	----	982.5-999.5				
	388	388-399				
998.5	----	983.5-999.5				
	399	884-399				
999.5	----	984.5-999.5				

High-band transmitter		Receiver channel/frequency				
Frequency	Channel	Required separation				
		-15 to +15	+50 (±3)	+60 (±3)	+100 (±3)	+120 (±3)
	400	400-415	447-468	467-468	497-503	517-523
1350.5	----	1350.5-1365.5	1397.5-1403.5	1407.5-1413.3	1447.5-1453.5	1467.5-1473.5
	401	400-416	448-464	468-464	498-604	518-524
1351.5	----	1350.5-1366.5	1398.5-1404.5	1408.5-1414.5	1448.5-1454.5	1468.5-1474.5
	402	400-417	449-466	469-466	499-606	519-525
1352.5	----	1350.5-1367.5	1399.5-1405.5	1409.5-1415.5	1449.5-1455.5	1469.5-1475.5
	403	400-418	450-466	460-466	600-606	520-526
1353.5	----	1350.5-1868.5	1400.5-1406.5	1410.5-1416.5	1450.5-1456.5	1470.5-1476.5
	404	400-419	451-457	461-467	501-507	621-527
1354.5	----	1850.5-1869.5	1401.5-1407.5	1411.5-1417.5	1451.5-1457.5	1471.5-1477.5
	405	400-420	462-468	462-468	602-608	522-528
1355.5	----	1350.5-1370.5	1402.5-1408.5	1412.5-1418.5	1452.5-1458.5	1472.5-1478.5

High-band transmitter		Receiver channel/frequency				
Frequency	Channel	Required separation				
		-15 to +15	+50 (±3)	+60 (±3)	+100 (±3)	+120 (±3)
1356.5	406	400-421	453-459	463-469	503-509	523-529
	----	1350.5-1371.5	1403.5-1409.5	1413.5-1419.5	1453.5-1459.5	1473.5-1479.5
1357.5	407	400-422	454-460	464-470	504-510	524-530
	----	1350.5-1372.5	1404.5-1410.5	1414.5-1420.5	1454.5-1460.5	1474.5-1480.5
1358.5	408	400-423	455-461	465-471	505-511	525-531
	----	1350.5-1373.5	1405.5-1411.5	1415.5-1421.5	1455.5-1461.5	1475.5-1481.5
1359.5	409	400-424	456-462	466-472	506-512	526-532
	----	1350.5-1374.5	1406.5-1412.5	1416.5-1422.5	1456.5-1462.5	1476.5-1482.5
1360.5	410	400-425	457-463	467-473	507-513	527-533
	----	1350.5-1375.5	1407.5-1413.5	1417.5-1423.5	1457.5-1463.5	1477.5-1483.5
1361.5	411	400-426	458-464	468-474	508-514	528-584
	----	1350.5-1376.5	1408.5-1414.5	1418.5-1424.5	1458.5-1464.5	1478.5-1484.5
1362.5	412	400-427	459-465	469-475	509-515	529-535
	----	1350.5-1377.5	1409.5-1415.5	1419.5-1425.5	1459.5-1465.5	1479.5-1485.5
1363.5	413	400-428	460-466	470-476	510-516	530-536
	----	1350.5-1378.5	1410.5-1416.5	1420.5-1426.5	1460.5-1466.5	1480.5-1486.5
1364.5	414	400-429	461-467	471-477	511-517	531-537
	----	1350.5-1379.5	1411.5-1417.5	1421.5-1427.5	1461.5-1467.5	1481.5-1487.5
1365.5	415	400-430	462-468	472-478	512-518	532-588
	----	1350.5-1380.5	1412.5-1418.5	1422.5-1428.5	1462.5-1468.5	1482.5-1488.5
1366.5	416	401-431	463-465	473-479	513-519	533-539
	----	1350.5-1381.5	1413.5-1419.5	1428.5-1429.5	1463.5-1469.5	1483.5-1489.5
1367.5	417	402-432	464-470	474-480	514-520	534-540
	----	1352.5-1382.5	1414.5-1420.5	1424.5-1430.5	1464.5-1470.5	1484.5-1490.5
1368.5	418	403-433	465-471	475-481	515-521	535-541
	----	1353.5-1383.5	1415.5-1421.5	1425.5-1431.5	1465.5-1471.5	1485.5-1491.5
1369.5	419	404-434	466-472	476-482	516-522	636-542
	----	1354.5-1384.5	1416.5-1422.5	1426.5-1432.5	1466.5-1466.5	1480.5-1486.5
1370.5	420	405-435	467-473	477-483	517-523	537-543
	----	1355.5-1385.5	1417.5-1423.5	1427.5-1438.5	1467.5-1473.5	1487.5-1493.5
1371.5	421	406-436	468-474	478-484	518-624	538-544
	----	1356.5-1386.5	1418.5-1424.5	1428.5-1434.5	1488.5-1474.5	1488.5-1494.5
1372.5	422	407-437	469-475	479-485	519-525	539-545
	----	1357.5-1387.5	1419.5-1425.5	1429.5-1485.5	1469.5-1475.5	1489.5-1495.5
1373.5	423	408-438	470-476	480-486	520-526	540-546
	----	1358.5-1388.5	1420.5-1426.5	1430.5-1436.5	1470.5-1476.5	1490.5-1496.5
1374.5	424	409-439	471-477	481-487	521-527	541-547
	----	1359.5-1389.5	1421.5-1427.5	1431.5-1437.5	1471.5-1477.5	1491.5-1497.5
1375.5	425	410-440	472-478	482-488	522-528	542-548
	----	1360.5-1390.5	1422.5-1428.5	1432.5-1438.5	1472.5-1478.5	1492.5-1498.5
1376.5	426	411-441	473-479	483-489	528-529	543-549
	----	1361.5-1391.5	1423.5-1429.5	1483.5-1439.5	1473.5-1479.5	1493.5-1499.5
1377.5	427	412-442	474-480	484-490	524-530	544-550
	----	1362.5-1392.5	1424.5-1430.5	1434.5-1440.5	1474.5-1480.5	1494.5-1500.5
1378.5	428	413-443	475-481	485-491	525-531	545-551
	----	1363.5-1398.5	1425.5-1431.5	1435.5-1441.5	1475.5-1481.5	1495.5-1501.5
1379.5	429	414-444	476-482	486-492	526-532	546-552
	----	1364.5-1394.5	1426.5-1432.5	1436.5-1442.5	1476.5-1482.5	1496.5-1502.5
1380.5	430	415-445	477-483	487-493	527-533	547-553
	----	1365.5-1395.5	1427.5-1433.5	1437.5-1443.5	1477.5-1483.5	1497.5-1503.5
1381.5	431	416-446	478-484	488-494	528-534	548-554
	----	1366.5-1396.5	1428.5-1434.5	1438.5-1444.5	1478.5-1484.5	1498.5-1504.5
1382.5	432	417-447	479-485	489-495	528-535	549-555
	----	1367.5-1397.5	1429.5-1435.5	1439.5-1445.5	1479.5-1485.5	1499.5-1505.5

AGO 10032A

High-band transmitter		Receiver channel/frequency				
Frequency	Channel	Required separation				
		-15 to +15	+50 (±3)	+60 (±3)	+100 (±3)	+120 (±3)
	433	418-448	480-486	490-496	530-536	560-556
1383.5	----	1368.5-1398.5	1430.5-1436.5	1440.5-1446.5	1480.5-1486.5	1500.5-1506.5
	434	419-449	481-487	491-497	531-537	551-557
1384.5	----	1369.5-1399.5	1431.5-1437.5	1441.5-1447.5	1481.5-1487.5	1501.5-1507.5
	435	420-450	482-488	492-498	532-538	552-558
1385.5	----	1370.5-1400.5	1432.5-1438.5	1442.5-1448.5	1482.5-1488.5	1502.5-1508.5
	436	421-451	483-489	493-499	533-539	553-559
1386.5	----	1371.5-1401.5	1433.5-1439.5	1443.5-1449.5	1483.5-1489.5	1503.5-1509.5
	437	422-452	484-490	494-500	534-540	554-560
1387.5	----	1372.5-1402.5	1434.5-1440.5	1444.5-1450.5	1484.5-1490.5	1504.5-1510.5
	438	423-453	485-491	495-501	535-541	555-561
1388.5	----	1373.5-1403.5	1435.5-1441.5	1445.5-1451.5	1485.5-1491.5	1505.5-1511.5
	439	424-454	486-492	496-502	536-542	556-562
1389.5	----	1374.5-1404.5	1436.5-1442.5	1446.5-1452.5	1486.5-1492.5	1506.5-1512.5
	440	425-455	487-493	497-503	537-543	557-563
1390.5	----	1375.5-1405.5	1437.5-1443.5	1447.5-1453.5	1487.5-1493.5	1507.5-1513.5
	441	426-456	488-494	498-504	538-544	558-564
1391.5	----	1376.5-1406.5	1438.5-1444.5	1448.5-1454.5	1488.5-1494.5	1508.5-1514.5
	442	427-457	489-495	499-505	539-545	559-565
1392.5	----	1377.5-1407.5	1439.5-1445.5	1449.5-1455.5	1489.5-1495.5	1509.5-1515.5
	443	428-458	490-496	500-506	540-546	560-566
1393.5	----	1378.5-1408.5	1440.5-1446.5	1450.5-1456.5	1490.5-1496.5	1510.5-1516.5
	444	429-459	491-497	501-507	541-547	561-567
1394.5	----	1379.5-1409.5	1441.5-1447.5	1451.5-1457.5	1491.5-1497.5	1511.5-1517.5
	445	430-460	492-498	502-508	542-548	562-568
1395.5	----	1380.5-1410.5	1442.5-1448.5	1452.5-1458.5	1492.5-1498.5	1512.5-1518.5
	446	431-461	493-499	503-509	543-549	563-569
1396.5	----	1381.5-1411.5	1443.5-1449.5	1453.5-1459.5	1493.5-1499.5	1513.5-1519.5
	447	432-462	494-500	504-510	544-550	564-570
1397.5	----	1382.5-1412.5	1444.5-1450.5	1454.5-1460.5	1494.5-1500.5	1514.5-1520.5
	448	433-463	495-501	505-511	545-551	565-571
1398.5	----	1383.5-1413.5	1445.5-1451.5	1455.5-1461.5	1495.5-1501.5	1515.5-1521.5
	449	434-446	496-502	506-512	546-552	566-572
1399.5	----	1384.5-1414.5	1446.5-1452.5	1456.5-1462.5	1496.5-1502.5	1516.5-1522.5
	450	435-465	497-503	507-513	547-553	567-573
1400.5	----	1385.5-1415.5	1447.5-1453.5	1457.5-1463.5	1497.5-1503.5	1517.5-1523.5
	451	436-466	498-504	508-614	548-554	568-574
1401.5	----	1386.5-1416.5	1448.5-1454.5	1458.5-1464.5	1498.5-1504.5	1518.5-1524.5
	452	437-467	499-605	509-515	549-555	569-575
1402.5	----	1387.5-1417.5	1449.5-1455.5	1459.5-1465.5	1499.5-1505.5	1519.5-1525.5
	453	438-468	500-506	510-516	550-556	570-576
1403.5	----	1388.5-1418.5	1450.5-1456.5	1460.5-1466.5	1500.5-1506.5	1520.5-1526.5
	454	439-469	501-507	511-517	551-557	671-577
1404.5	----	1389.5-1419.5	1451.5-1457.5	1461.5-1467.5	1501.5-1507.5	1521.5-1527.5
	455	440-470	502-508	512-518	552-558	572-578
1405.5	----	1390.5-1420.5	1452.5-1458.5	1462.5-1468.5	1502.5-1508.5	1522.5-1528.5
	456	441-471	603-509	513-519	553-559	673-579
1406.5	----	1391.5-1421.5	1453.5-1459.5	1463.5-1469.5	1503.5-1509.5	1523.5-1529.5
	457	442-472	504-510	514-520	554-560	574-580
1407.5	----	1392.5-1422.5	1454.5-1460.5	1464.5-1470.5	1504.5-1510.5	1524.5-1530.5
	458	443-473	505-511	515-521	555-561	575-581
1408.5	----	1393.5-1423.5	1455.5-1461.5	1465.5-1471.5	1505.5-1511.5	1525.5-1531.5
	459	444-474	506-512	616-522	556-562	576-582
1409.5	----	1394.5-1424.5	1456.5-1462.5	1466.5-1472.5	1506.5-1512.5	1526.5-1532.5

AGO 10032A

High-band transmitter		Receiver channel/frequency				
Frequency	Channel	Required separation				
		-15 to +15	+50 (±3)	+60 (±3)	+100 (±3)	+120 (±3)
	460	445-475	507-513	517 -523	557 -563	577 -583
1410.5	----	1395.5-1425.5	1457.5-1463.5	1467.5-1473.5	1507.5-1513.5	1527.5-1533.5
	461	446-476	508-514	518-524	558-564	578-584
1411.5	----	1396.5-1426.5	1458.5-1464.5	1468.5-1474.5	1508.5-1514.5	1528.5-1534.5
	462	447-477	509-515	519-525	559-565	579-585
1412.5	----	1397.5-1427.5	1459.5-1465.5	1469.5-1475.5	1509.5-1515.5	1529.5-1535.5
	463	448-478	510-516	520-526	560-566	580-586
1413.5	----	1398.5-1428.5	1460.5-1466.5	1470.5-1476.5	1510.5-1516.5	1530.5-1536.5
	464	449-479	511-517	521-527	561-567	581-587
1414.5	----	1399.5-1429.5	1461.5-1467.5	1471.5-1477.5	1511.5-1517.5	1531.5-1537.5
	465	450-480	512-518	622-528	562-568	682-588
1415.5	----	1400.5-1430.5	1462.5-1468.5	1472.5-1478.5	1512.5-1518.5	1532.5-1538.5
	466	451-481	513-519	523-529	563-569	583-589
1416.5	----	1401.5-1431.5	1463.5-1469.5	1473.5-1479.5	1513.5-1519.5	1533.5-1539.5
	467	452-482	514-520	524-530	564-570	584-590
1417.5	----	1402.5-1432.5	1464.5-1470.5	1474.5-1480.5	1514.5-1520.5	1534.5-1540.5
	468	453-483	515-521	525-531	565-571	585-591
1418.5	----	1403.5-1433.5	1465.5-1471.5	1475.5-1481.5	1515.5-1521.5	1535.5-1541.5
	469	454-484	516-522	526-532	566-572	586-592
1419.5	----	1404.5-1434.5	1466.5-1472.5	1476.5-1482.5	1516.5-1522.5	1536.5-1542.5
	470	455-485	517-523	527-533	567-573	587-593
1420.5	----	1405.5-1435.5	1467.5-1473.5	1477.5-1483.5	1517.5-1523.5	1537.5-1543.5
	471	456-486	518-524	528-534	568-574	588-594
1421.5	----	1406.5-1436.5	1468.5-1474.5	1478.5-1484.5	1518.5-1524.5	1538.5-1544.5
	472	457-487	519-525	529-535	569-575	589-595
1422.5	----	1407.5-1437.5	1469.5-1475.5	1479.5-1485.5	1519.5-1525.5	1539.5-1545.5
	473	458-488	520-526	530-536	570-576	590-596
1423.5	----	1408.5-1438.5	1470.5-1476.5	1480.5-1486.5	1520.5-1526.5	1540.5-1546.5
	474	459-489	521-527	531-537	571-577	591-597
1424.5	----	1409.5-1439.5	1471.5-1477.5	1481.5-1487.5	521.5-1527.5	1541.5-1547.5
	475	460-490	522-528	532-638	572-578	592-598
1425.5	----	1410.5-1440.5	1472.5-1478.5	1482.5-1488.5	1522.5-1528.5	1542.5-1548.5
	476	461-491	523-529	533-539	573-579	593-599
1426.5	----	1411.5-1441.5	1473.5-1479.5	1483.5-1489.5	1523.5-1529.5	1543.5-1549.5
	477	462-492	524-530	534-540	574-580	594-600
1427.5	----	1412.5-1442.5	1474.5-1480.5	1484.5-1490.5	1524.5-1530.5	1544.5-1550.5
	478	463-493	525-531	535-541	575-581	595-601
1428.5	----	1413.5-1443.5	1475.5-1481.5	1485.5-1491.5	1525.5-1531.5	1545.5-1551.5
	479	464-494	526-532	536-542	576-582	596-602
1429.5	----	1414.5-1444.5	1476.5-1482.5	1486.5-1492.5	1526.5-1532.5	1546.5-1552.5
	480	465-495	527-533	537-543	577-583	597-603
1430.5	----	1415.5-1445.5	1477.5-1483.5	1487.5-1493.5	527.5-1533.5	1547.5-1563.5
	481	466-496	528-534	538-544	578-584	598-604
1431.5	----	1416.5-1446.5	1478.5-1484.5	1488.5-1494.5	1528.5-1534.5	1548.5-1554.5
	482	467-497	529-535	539-545	579-585	599-605
1432.5	----	1417.5-1447.5	1479.5-1485.5	1489.5-1495.5	529.5-1535.5	1549.5-1555.5
	483	468-498	530-536	540-546	580-586	600-606
1433.5	----	1418.5-1448.5	1480.5-1486.5	1490.5-1496.5	1530.5-1536.5	1550.5-1556.5
	484	469-499	531-537	541-547	581-587	601-607
1434.5	----	1419.5-1449.5	1481.5-1487.5	1491.5-1497.5	531.5-1537.5	1551.5-1557.5
	485	470-500	532-538	542-548	582-588	602-608
1435.5	----	1420.5-1450.5	1482.5-1488.5	1492.5-1498.5	1532.5-1538.5	1552.5-1558.5
	486	471-501	533-639	543-549	583-589	603-609
1436.5	----	1421.5-1451.5	1483.5-1489.5	1493.5-1499.5	1533.5-1539.5	1553.5-1559.5

AGO 10032A

High-band transmitter		Receiver channel/frequency				
Frequency	Channel	Required separation				
		-15 to +15	+50 (±3)	+60 (±3)	+100 (±3)	+120 (±3)
1437.5	487	472-602	634-540	544-560	584-590	604-610
	----	1422.5-1462.5	1484.5-1490.5	1494.5-1500.5	1534.5-1540.5	1554.5-1560.5
	488	473-503	535-541	545-551	585-591	605-611
1438.5	----	1423.5-1453.5	1485.5-1491.5	1495.5-1501.5	1535.5-1541.5	1665.5-1661.5
	489	474-504	536-542	546-562	586-592	606-612
1439.5	----	1424.5-1454.5	1486.5-1492.5	1496.5-1502.5	1536.5-1542.5	1556.5-1562.5
	490	475-505	537-543	547-553	587-593	607-613
1440.5	----	1425.5-1455.5	1487.5-1493.5	1497.5-1503.5	1537.5-1543.5	1551.5-1563.5
	491	476-506	538-544	548-664	588-594	608-614
1441.5	----	1426.5-1466.5	1488.5-1494.5	1498.5-1504.5	1538.5-1544.5	1558.5-1564.5
	492	477-507	539-545	549-555	589-595	609-615
1442.5	----	1427.5-1457.5	1489.5-1495.5	1499.5-1505.5	1539.5-1545.5	1559.5-1565.5
	493	478-508	640-646	550-556	590-596	610-616
1443.5	----	1428.5-1458.5	1490.5-1496.5	1500.5-1606.5	1540.5-1546.5	1560.5-1566.5
	494	479-509	541-547	651-567	591-597	611-617
1444.5	----	1429.5-1459.5	1491.5-1497.5	1501.5-1507.5	1541.5-1547.5	1561.5-1567.5
	495	480-510	542-548	552-558	592-598	612-618
1446.5	----	1430.5-1460.5	1492.5-1498.5	1502.5-1508.5	1642.5-1548.5	1662.5-1568.5
	496	481-511	543-549	553-559	593-599	613-619
1446.5	----	1431.5-1461.5	1493.5-1499.5	1503.5-1509.5	1543.5-1549.5	1563.5-1569.5
	497	482-512	644-650	554-560	594-600	614-620
1447.5	----	1432.5-1462.5	1494.5-1500.5	1504.5-1510.5	1544.5-1560.5	1564.5-1670.5
	498	483-513	545-551	555-561	595-601	615-621
1448.5	----	1433.5-1463.5	1495.5-1501.5	1505.5-1511.5	1545.5-1551.5	1565.5-1571.5
	499	484-514	646-552	656-662	596-602	616-622
1449.5	----	1434.5-1464.5	1496.5-1502.5	1506.5-1512.5	1546.5-1552.5	1566.5-1572.5
	500	486-515	547-553	557-563	597-603	617-623
1450.5	----	1435.5-1465.5	1497.5-1603.5	1507.5-1513.5	1547.5-1553.5	1667.5-1673.5
	501	486-516	548-654	568-564	698-604	618-624
1451.5	----	1436.5-1466.5	1498.5-1504.5	1508.5-1514.5	1548.5-1554.5	1568.5-1574.5
	502	487-517	549-555	559-565	599-605	619-625
1452.5	----	1437.5-1467.5	1499.5-1505.5	1509.5-1515.5	1549.5-1555.5	1569.5-1575.5
	503	488-518	550-556	560-566	600-606	620-626
1453.5	----	1438.5-1468.5	1500.5-1506.5	1510.5-1516.5	1650.5-1566.5	1670.5-1676.5
	504	489-619	651-667	661-667	601-607	621-627
1454.5	----	1439.5-1469.5	1501.5-1507.5	1511.5-1517.5	1551.5-1557.5	1571.5-1577.5
	506	490-520	552-558	662-568	602-608	622-628
1455.5	----	1440.5-1470.5	1502.5-1508.5	1512.5-1518.5	1552.5-1558.5	1572.5-1578.5
	506	491-521	553-559	563-669	603-609	623-629
1456.5	----	1441.5-1471.5	1503.5-1509.5	1513.5-1519.5	1553.5-1559.5	1573.5-1579.5
	507	492-522	554-560	664-670	604-610	624-630
1457.5	----	1442.5-1472.5	1504.5-1510.5	1614.5-1620.5	1554.5-1560.5	1574.5-1580.5
	508	493-523	555-561	565-571	605-611	625-631
1458.5	----	1443.5-1473.5	1505.5-1511.5	1515.5-1521.5	1555.5-1561.5	1575.5-1581.5
	509	494-524	556-562	566-672	606-612	626-632
1459.5	----	1444.5-1474.5	1506.5-1512.5	1516.5-1522.5	1556.5-1562.5	1576.5-1582.5
	510	496-626	567-563	567-573	607-613	627-633
1460.5	----	1445.5-1475.5	1507.5-1513.5	1517.5-1523.5	1667.5-1563.5	1577.5-1583.5
	511	496-626	558-664	668-574	608-614	628-634
1461.5	----	1446.5-1476-5	1508.5-1514.5	1518.5-1524.5	1558.5-1564.5	1578.5-1684.5
	512	497-627	559-665	569-575	609-615	629-635
1462.5	----	1447.5-1477.5	1509.5-1515.5	1519.5-1525.5	1559.5-1565.5	1579.5-1585.5
	513	498-528	660-566	670-576	610-616	630-636
1463.5	----	1448.5-1478.5	1510.5-1516.5	1520.5-1526.5	1560.5-1566.5	1580.5-1586.5

AGO 10032A

C1, TM 11-5820-461-12

High-band transmitter		Receiver channel/frequency				
Frequency	Channel	Required separation				
		-15 to +15	+50 (±3)	+60 (±3)	+100 (±3)	+120 (±3)
1464.5	514	499-629	661-567	571-577	611-617	631-637
	----	1449.5-1479.5	1611.5-1617.5	1521.5-1527.5	1661.5-1567.5	1581.5-1587.5
	515	600-530	562-568	672-678	612-618	632-638
1465.5	----	1460.5-1480.5	1512.5-1518.5	1522.5-1528.5	1662.5-1668.5	1682.5-1588.5
	516	501-631	663-569	573-579	613-619	633-639
1466.5	----	1451.5-1481.5	1613.5-1519.5	1523.5-1529.5	1563.5-1569.5	1583.5-1689.5
	517	502-532	564-570	574-580	614-620	634-640
1467.5	----	1452.5-1482.5	1514.5-1520.5	1524.5-1550.5	1564.5-1570.5	1684.5-1690.5
	518	503-533	565-571	676-581	616-621	636-641
1468.5	----	1453.5-1483.5	1515.5-1521.5	1525.5-1531.5	1565.5-1671.5	1586.5-1691.5
	519	604-534	566-572	576-582	616-622	636-642
1469.5	----	1454.5-1484.5	1516.5-1522.5	1526.5-1532.5	1566.5-1572.5	1586.5-1692.5
	520	505-535	567-573	577-583	617-623	637-643
1470.5	----	1455.5-1485.5	1517.5-1523.5	1527.5-1533.5	1567.5-1573.5	1587.5-1693.5
	521	506-536	568-574	578-584	618-624	638-644
1471.5	----	1456.5-1486.5	1518.5-1524.5	1528.5-1534.5	1568.5-1574.5	1588.5-1594.5
	522	507-537	669-575	579-585	619-625	639-645
1472.5	----	1467.5-1487.5	1519.5-1525.5	1529.5-1535.5	1569.5-1575.5	1689.5-1695.5
	523	508-538	570-576	680-586	620-626	640-646
1473.5	----	1468.5-1488.5	1520.5-1526.5	1530.5-1636.5	1570.5-1576.5	1690.5-1596.5
	524	509-539	571-577	581-587	621-627	641-647
1474.5	----	1459.5-1489.5	1521.5-1527.5	1531.5-1537.5	1571.5-1577.5	1591.5-1597.5
	525	510-540	572-578	682-588	622-628	642-648
1475.5	----	1460.5-1490.5	1522.5-1528.5	1532.5-1538.5	1572.5-1578.5	1592.5-1598.5
	526	511-541	573-579	583-589	623-629	643-649
1476.5	----	1461.5-1491.5	1623.5-1529.5	1533.5-1539.5	1573.5-1579.5	1593.5-1599.5
	527	512-542	574-580	684-590	624-630	644-650
1477.5	----	1462.5-1492.5	1524.5-1530.5	1534.5-1540.5	1574.5-1580.5	1594.5-1600.5
	528	513-543	575-581	585-591	625-631	645-651
1478.5	----	1463.5-1493.5	1625.5-1531.5	1535.5-1541.5	1575.5-1581.5	1595.5-1601.5
	529	514-544	576-582	686-592	626-632	646-652
1479.5	----	1464.5-1494.5	1526.5-1532.5	1536.5-1542.5	1576.5-1582.5	1696.5-1602.5
	530	515-545	577-583	587-593	627-633	647-653
1480.5	----	1465.5-1495.5	1527.5-1533.5	1637.5-1643.5	1577.5-1583.5	1697.5-1603.5
	531	516-546	578-584	588-694	628-684	648-664
1481.5	----	1466.5-1496.5	1628.5-1634.5	1538.5-1544.5	1578.5-1584.5	1598.5-1604.5
	532	517-547	579-585	589-595	629-635	649-655
1482.5	----	1467.5-1497.5	1529.5-1535.5	1539.5-1545.5	1579.5-1686.5	1599.5-1605.5
	533	518-548	580-586	590-596	630-636	650-656
1483.5	----	1468.5-1498.5	1530.5-1536.5	1540.5-1546.5	1580.5-1586.5	1600.5-1606.5
	534	519-549	581-587	591-597	631-637	661-667
1484.5	----	1469.5-1499.5	1531.5-1537.5	1541.5-1547.5	1581.5-1687.5	1601.5-1607.5
	535	520-550	582-588	592-598	632-638	652-668
1485.5	----	1470.5-1500.5	1532.5-1538.5	1542.5-1548.5	1582.5-1588.5	1602.5-1608.5
	536	521-551	583-589	593-599	633-639	653-659
1486.5	----	1471.5-1501.5	1533.5-1539.5	1543.5-1549.5	1583.5-1589.5	1603.5-1609.5
	537	522-552	584-590	694-600	634-640	664-660
1487.5	----	1472.5-1502.5	1534.5-1540.5	1544.5-1550.5	1584.5-1590.5	1604.5-1610.5
	538	523-553	585-691	595-601	635-641	655-661
1488.5	----	1473.5-1503.5	1535.5-1541.5	1545.5-1551.5	1585.5-1591.5	1605.5-1611.5
	539	524-554	586-592	596-602	636-642	656-662
1489.5	----	1474.5-1504.5	1536.5-1542.5	1546.5-1552.5	1586.5-1592.5	1606.5-1612.5
	540	525-555	587-593	597-603	637-643	667-663
1490.5	----	1475.5-1605.5	1537.5-1543.5	1547.5-1553.5	1587.5-1593.5	1607.5-1613.5

AGO 10032A

High-band transmitter		Receiver channel/frequency				
Frequency	Channel	Required separation				
		-15 to +15	+50 (±3)	+60 (±3)	+100 (±3)	+120 (±3)
1491.5	541	526-556	588-594	598-604	638-644	658-664
	----	1476.5-1506.5	1538.5-1544.5	1548.5-1554.5	1588.5-1594.5	1608.5-1614.5
1492.5	542	527-557	589-595	599-605	639-645	659-665
	----	1477.5-1507.5	1539.5-1545.5	1549.5-1555.5	1589.5-1595.5	1609.5-1615.5
1493.5	543	528-668	590-596	600-606	640-646	660-666
	----	1478.5-1508.5	1540.5-1546.5	1660.5-1556.5	1590.5-1596.5	1610.5-1616.5
1494.5	544	529-559	591-597	601-607	641-647	661-667
	----	1479.5-1509.5	1541.5-1547.5	1551.5-1557.5	1591.5-1597.5	1611.5-1617.5
1495.5	545	530-560	592-598	602-608	642-648	662-668
	----	1480.5-1510.5	1542.5-1548.5	1552.5-1558.5	1592.5-1598.5	1612.5-1618.5
1496.5	546	531-561	593-599	603-609	643-649	663-669
	----	1481.5-1511.5	1543.5-1549.5	1553.5-1559.5	1593.5-1599.5	1613.5-1619.5
1497.5	547	532-562	594-600	604-610	644-650	664-670
	----	1482.5-1512.5	1544.5-1550.5	1554.5-1560.5	1594.5-1600.5	1614.5-1620.5
1498.5	548	533-563	595-601	605-611	645-651	665-671
	----	1483.5-1513.5	1545.5-1551.5	1555.5-1561.5	1595.5-1601.5	1615.5-1621.5
1499.5	549	534-564	596-602	606-612	646-652	666-672
	----	1484.5-1514.5	1546.5-1552.5	1556.5-1562.5	1596.5-1602.5	1616.5-1622.5
1500.5	550	535-565	597-603	607-613	647-653	667-673
	----	1485.5-1515.5	1547.5-1553.5	1557.5-1563.5	1597.5-1603.5	1617.5-1623.5
1501.5	551	536-566	598-604	608-614	648-654	668-674
	----	1486.5-1516.5	1548.5-1554.5	1558.5-1564.5	1598.5-1604.5	1618.5-1624.5
1502.5	552	537-567	599-605	609-615	649-655	669-675
	----	1487.5-1517.5	1549.5-1555.5	1559.5-1565.5	1599.5-1605.5	1619.5-1625.5
1503.5	553	538-568	600-606	610-616	650-656	670-676
	----	1488.5-1518.5	1550.5-1556.5	1560.5-1566.5	1600.5-1606.5	1620.5-1626.5
1504.5	554	539-569	601-607	611-617	651-657	671-677
	----	1489.5-1519.5	1551.5-1557.5	1561.5-1567.5	1601.5-1607.5	1621.5-1627.5
1505.5	555	540-570	602-608	612-618	652-658	672-678
	----	1490.5-1520.5	1552.5-1558.5	1562.5-1568.5	1602.5-1608.5	1622.5-1628.5
1506.5	556	541-571	603-609	613-619	653-659	673-679
	----	1491.5-1521.5	1553.5-1559.5	1563.5-1569.5	1603.5-1609.5	1623.5-1629.5
1507.5	557	542-572	604-610	614-620	654-660	674-680
	----	1492.5-1522.5	1554.5-1560.5	1564.5-1570.5	1604.5-1610.5	1624.5-1630.5
1508.5	558	543-513	605-611	615-621	655-661	675-681
	----	1493.5-1523.5	1555.5-1561.5	1565.5-1571.5	1605.5-1611.5	1625.5-1631.5
1509.5	559	544-574	606-612	616-622	656-662	676-682
	----	1494.5-1524.5	1556.5-1562.5	1566.5-1572.5	1606.5-1612.5	1626.5-1632.5
1510.5	560	545-575	607-613	617-623	657-663	677-683
	----	1495.5-1525.5	1557.5-1563.5	1567.5-1573.5	1607.5-1613.5	1627.5-1633.5
1511.5	561	546-576	608-614	618-624	658-664	678-684
	----	1496.5-1526.5	1558.5-1564.5	1568.5-1574.5	1608.5-1614.5	1628.5-1634.5
1512.5	562	547-577	609-615	619-625	659-665	679-685
	----	1497.5-1527.5	1559.5-1565.5	1569.5-1575.5	1609.5-1615.5	1629.5-1635.5
1513.5	563	548-578	610-616	620-626	660-666	680-686
	----	1498.5-1528.5	1560.5-1566.5	1670.5-1676.5	1610.5-1616.5	1630.5-1636.5
1514.5	564	549-579	611-617	621-627	661-667	681-687
	----	1499.5-1529.5	1561.5-1567.5	1571.5-1577.5	1611.5-1617.5	1631.5-1637.5
1515.5	565	550-580	612-618	622-628	662-668	682-688
	----	1500.5-1530.5	1562.5-1568.5	1572.5-1578.5	1612.5-1618.5	1632.5-1638.5
1516.5	566	551-581	613-619	623-629	663-669	683-689
	----	1501.5-1531.5	1563.5-1569.5	1573.5-1579.5	1613.5-1619.5	1633.5-1639.5
1517.5	567	552-582	614-620	624-630	664-670	684-690
	----	1502.5-1532.5	1564.5-1570.5	1574.5-1580.5	1614.5-1620.5	1634.5-1640.5

AGO 10032A

High-band transmitter		Receiver channel/frequency				
Frequency	Channel	Required separation				
		-15 to +15	+50 (±3)	+60 (±3)	+100 (±3)	+120 (±3)
	568	553-583	615-621	625-631	665-671	685-691
1518.5	----	1503.5-1533.5	1565.5-1571.5	1575.5-1581.5	1615.5-1621.5	1635.5-1641.5
	569	554-584	616-622	626-632	666-672	686-692
1519.5	----	1504.5-1534.5	1566.5-1572.5	1576.5-1582.5	1616.5-1622.5	1636.5-1642.5
	570	555-585	617-623	627-633	667-673	687-693
1520.5	----	1505.5-1535.5	1567.5-1573.5	1577.5-1583.5	1617.5-1623.5	1637.5-1643.5
	571	556-586	618-624	628-634	668-674	688-694
1521.5	----	1506.5-1536.5	1568.5-1574.5	1578.5-1584.5	1618.5-1624.5	1638.5-1644.5
	572	557-587	619-625	629-635	669-675	689-695
1522.5	----	1507.5-1537.5	1569.5-1575.5	1579.5-1585.5	1619.5-1625.5	1639.5-1645.5
	573	558-688	620-626	630-636	670-676	690-696
1523.5	----	1508.5-1538.5	1570.5-1576.5	1580.5-1586.5	1620.5-1626.5	1640.5-1646.5
	574	559-589	621-627	631-637	671-677	691-697
1524.5	----	1509.5-1539.5	1571.5-1577.5	1581.5-1587.5	1621.5-1627.5	1641.5-1647.5
	575	560-590	622-628	632-638	672-678	692-698
1525.5	----	1510.5-1540.5	1572.5-1578.5	1582.5-1588.5	1622.5-1628.5	1642.5-1648.5
	576	561-591	623-629	633-639	673-679	693- 699
1526.5	----	1511.5-1541.5	1573.5-1579.5	1583.5-1589.5	1623.5-1629.5	1643.5-1649.5
	577	562-592	624-630	634-640	674-680	694-700
1527.5	----	1512.5-1542.5	1574.5-1580.5	1584.5-1590.5	1624.5-1630.5	1644.5-1650.5
	578	563-593	625-631	635-641	675-681	695-702
1528.5	----	1513.5-1543.5	1575.5-1581.5	1585.5-1591.5	1625.5-1631.5	1645.5-1651.5
	579	664-594	626-632	636-642	676-682	696-702
1529.5	----	1514.5-1644.5	1576.5-1582.5	1586.5-1592.5	1626.5-1632.5	1646.5-1652.5
	580	665-595	627-633	637-643	677-683	697-703
1530.5	----	1516.5-1546.5	1677.5-1583.5	1687.5-1693.5	1627.5-1633.5	1647.5-1653.5
	581	666-596	628-634	638-644	678-684	1;08-704
1531.5	----	1516.5-1546.5	1578.5-1584.5	1588.5-1594.5	1628.5-1634.5	1648.5-1654.5
	582	567-597	629-635	639-646	679-686	699-705
1532.5	----	1517.5-1547.5	1579.5-1585.5	1589.5-1595.5	1629.5-1635.5	1649.5-1655.5
	583	668-698	630-636	640-646	680-686	700-706
1533.5	----	1518.5-1548.5	1580.5-1586.5	1590.5-1596.5	1630.5-1636.5	1650.5-1656.5
	584	569-599	631-637	641-647	681-687	701-707
1534.5	----	1519.5-1549.5	1581.5-1587.5	1591.5-1597.5	1631.5-1637.5	1651.5-1657.5
	585	570-600	632-638	642-648	682-688	702-708
1535.5	----	1520.5-1550.5	1582.5-1588.5	1692.5-1698.5	1632.5-1638.5	1652.5-1658.5
	586	571-601	633-639	643-649	683-689	703-709
1536.5	----	1521.5-1551.5	1583.5-1589.5	1593.5-1599.5	1633.5-1639.5	1653.5-1659.5
1537.5	----	1522.5-1552.5	1584.5-1590.5	1594.5-1600.5	1634.5-1640.5	1654.5-1660.5
	588	573-603	635-641	645-651	685-691	705-711
1538.5	----	1523.5-1553.5	1585.5-1591.5	1595.5-1601.5	1635.5-1641.5	1655.5-1661.5
	589	574-604	636-642	646-652	686-692	706-712
1539.5	----	1524.5-1554.5	1586.5-1692.5	1696.5-1602.5	1636.5-1642.5	1656.5-1662.5
	590	575-605	637-643	647-653	687-693	707-713
1540.5	----	1525.5-1555.5	1587.5-1593.5	1597.5-1603.5	1637.5-1643.5	1657.5-1663.5
	591	576-606	638-644	648-654	688-694	708-714
1541.5	----	1526.5-1556.5	1588.5-1594.5	1698.5-1604.5!;	1638.5-1644.5	1668.5-1664.5
	592	577-607	639-645	649-665	689-695	709-716
1542.5	----	1527.5-1557.5	1589.5-1595.5	1599.5-1605.5	1639.5--1645.5	1669.5-1665.5
	593	578-608	640-646	650-656	690-696	710-716
1543.5	----	1528.5-1558.5	1590.5-1596.5	1600.5-1606.5	1640.5-1646.5	1660.5-1666.5
	594	579-609	641-647	651-657	691-697	711-717
1544.5	----	1529.5-1559.5	1591.5-1597.5	1601.5-1607.5	1641.5-1647.5	1661.5-1667.5

AGO 10032A

C1, TM 11-5820-461-12

High-band transmitter		Receiver channel/frequency				
Frequency	Channel	Required separation				
		-15 to +15	+50 (±3)	+60 (±3)	+100 (±3)	+120 (±3)
1545.5	595	580-610	642-648	652-658	692-698	712-718
	----	1530.5-1560.5	1592.5-1598.5	1602.5-1608.5	1642.5-1648.5	1662.5-1668.5
	596	581-611	643-649	653-659	693-699	713-719
1546.5	----	1531.5-1561.5	1593.5-1599.5	1603.5-1609.5	1643.5-1649.5	1663.5-1669.5
	597	582-612	644-650	654-660	694-700	714-720
1547.5	----	1532.5-1562.5	1594.5-1600.5	1604.5-1610.5	1644.5-1650.5	1664.5-1670.5
	598	583-613	645-651	655-661	695-701	715-721
1548.5	----	1533.5-1563.5	1595.5-1601.5	1605.5-1611.5	1645.5-1651.5	1665.5-1671.5
	599	584-614	646-652	656-662	696-702	716-722
1549.5	----	1534.5-1564.5	1596.5-1602.5	1606.5-1612.5	1646.5-1652.5	1666.5-1672.5
	600	585-615	647-653	657-663	697-703	717-723
1550.5	----	1535.5-1565.5	1597.5-1603.5	1607.5-1613.5	1647.5-1653.5	1667.5-1673.5
	601	586-616	648-654	668-664	698-704	718-724
1551.5	----	1536.5-1566.5	1698.5-1604.5	1608.5-1614.5	1648.5-1654.5	1668.5-1674.5
	602	587-617	649-665	659-665	699-705	719-725
1552.5	----	1537.5-1567.5	1599.5-1605.5	1609.5-1615.5	1649.5-1655.5	1669.5-1675.5
	603	588-618	650-656	660-666	700-706	720-726
1553.5	----	1538.5-1568.5	1600.5-1606.5	1610.5-1616.5	1650.5-1656.5	1670.5-1676.5
	604	589-619	651-657	661-667	701-707	721-727
1554.5	----	1539.5-1569.5	1601.5-1607.5	1611.5-1617.5	1651.5-1657.5	1671.5-1677.5
	605	590-620	652-658	662-668	702-708	722-728
1555.5	----	1540.5-1570.5	1602.5-1608.5	1612.5-1618.5	1652.5-1658.5	1672.5-1678.5
	606	591-621	653-659	663-669	703-709	723-729
1556.5	----	1541.5-1571.5	1603.5-1609.5	1613.5-1619.5	1653.5-1659.5	1673.5-1679.5
	607	592-622	654-660	664-670	704-710	724-730
1557.5	----	1642.5-1572.5	1604.5-1610.5	1614.5-1620.5	1654.5-1660.5	1674.5-1680.5
	608	593-623	655-661	665-671	705-711	725-731
1558.5	----	1543.5-1573.5	1605.5-1611.5	1615.5-1621.5	1655.5-1661.5	1675.5-1681.5
	609	594-624	656-662	666-672	706-712	726-732
1559.5	----	1544.5-1574.5	1606.5-1612.5	1616.5-1622.5	1656.5-1662.5	1676.5-1682.5
	610	595-625	657-663	667-673	707-713	727-733
1560.5	----	1545.5-1575.5	1607.5-1613.5	1617.5-1623.5	1657.5-1663.5	1677.5-1683.5
	611	596-626	658-664	668-674	708-714	728-734
1561.5	----	1546.5-1576.5	1608.5-1614.5	1618.5-1624.5	1658.5-1664.5	1678.5-1684.5
	612	597-627	659-665	669-675	709-715	729-735
1562.5	----	1547.5-1577.5	1609.5-1615.5	1619.5-1625.5	1659.5-1665.5	1679.5-1685.5
	613	598-628	660-666	670-676	710-716	730-736
1563.5	----	1548.5-1578.5	1610.5-1616.5	1620.5-1626.5	1660.5-1666.5	1680.5-1686.5
	614	599-629	661-667	671-677	711-717	731-737
1564.5	----	1549.5-1579.5	1611.5-1617.5	1621.5-1627.5	1661.5-1667.5	1681.5-1687.5
	615	600-630	662-668	672-678	712-718	732-738
1665.5	----	1550.5-1580.5	1612.5-1618.5	1622.5-1628.5	1662.5-1668.5	1682.5-1688.5
	616	601-631	663-669	673-679	713-719	733-739
1566.5	----	1551.5-1581.5	1613.5-1619.5	1623.5-1629.5	1663.5-1669.5	1683.5-1689.5
	617	602-632	664-670	674-680	714-720	734-740
1567.5	----	1552.5-1582.5	1614.5-1620.5	1624.5-1630.5	1664.5-1670.5	1684.5-1690.5
	618	603-633	665-671	675-681	715-721	735-741
1568.5	----	1553.5-1583.5	1615.5-1621.5	1625.5-1631.5	1665.5-1671.5	1685.5-1691.5
	619	604-634	666-672	676-682	716-722	736-742
1569.5	----	1554.5-1584.5	1616.5-1622.5	1626.5-1632.5	1666.5-1672.5	1686.5-1692.5
	620	605-635	667-673	677-683	717-723	737-743
1570.5	----	1555.5-1585.5	1617.5-1623.5	1627.5-1633.5	1667.5-1673.5	1687.5-1693.5
	621	606-636	668-674	678-684	718-724	738-744
1571.5	----	1556.5-1586.5	1618.5-1624.5	1628.5-1634.5	1668.5-1674.5	1688.5-1694.5

AGO 10032A

C1, TM 11-5820-461-12

High-band transmitter		Receiver channel/frequency				
Frequency	Channel	Required separation				
		-15 to +15	+50 (±3)	+60 (±3)	+100 (±3)	+120 (±3)
1572.5	622	607-637	669-675	679-685	719-725	739-745
	----	1557.5-1587.5	1619.5-1625.5	1629.5-1635.5	1669.5-1675.5	1689.5-1695.5
	623	608-638	670-676	680-686	720-726	740-746
1573.5	----	1558.5-1588.5	1620.5-1626.5	1630.5-1636.5	1670.5-1676.5	1690.5-1696.5
	624	609-639	671-677	681-687	721-727	741-747
1574.5	----	1559.5-1589.5	1621.5-1627.5	1631.5-1637.5	1671.5-1677.5	1691.5-1697.5
	625	610-640	672-678	682-688	722-728	742-748
1575.5	----	1560.5-1590.5	1622.5-1628.5	1632.5-1638.5	1672.5-1678.5	1692.5-1698.5
	626	611-641	673-679	683-689	723-729	743-749
1576.5	----	1561.5-1591.5	1623.5-1629.5	1633.5-1639.5	1673.5-1679.5	1693.5-1699.5
	627	612-642	674-680	684-690	724-730	744-750
1577.5	----	1562.5-1692.5	1624.5-1630.5	1634.5-1640.5	1674.5-1680.5	1694.5-1700.5
	628	613-643	675-681	685-691	725-731	745-751
1578.5	----	1563.5-1593.5	1625.5-1631.5	1635.5-1641.5	1675.5-1681.5	1695.5-1701.5
	629	614-644	676-682	686-692	726-782	746-752
1579.5	----	1564.5-1694.5	1626.5-1632.5	1636.5-1642.5	1676.5-1682.5	1696.5-1702.5
	630	616-645	677-683	687-693	727-733	747-753
1580.5	----	1565.5-1595.5	1627.5-1633.5	1637.5-1643.5	1677.5-1683.5	1697.5-1703.5
	631	616-646	678-684	688-694	728-734	748-754
1581.5	----	1566.5-1696.5	1628.5-1634.5	1638.5-1644.5	1678.5-1684.5	1698.5-1704.5
	632	617-647	679-685	689-695	729-735	749-755
1582.5	----	1567.5-1597.5	1629.5-1635.5	1639.5-1645.5	1679.5-1685.5	1699.5-1705.5
	633	618-648	680-686	690-696	730-736	750-756
1583.5	----	1568.5-1598.5	1630.5-1636.5	1640.5-1646.5	1680.5-1686.5	1700.5-1706.5
	634	619-649	681-687	691-697	731-737	751-757
1584.5	----	1569.5-1599.5	1631.5-1637.5	1641.5-1647.5	1681.5-1687.5	1701.5-1707.5
	635	620-650	682-688	692-698	732-738	752-758
1585.5	----	1570.5-1600.5	1632.5-1638.5	1642.5-1648.5	1682.5-1688.5	1702.5-1708.5
	636	621-661	683-689	693-699	733-739	753-759
1586.5	----	1571.5-1601.5	1633.5-1639.5	1643.5-1649.5	1683.5-1689.5	1703.5-1709.5
	637	622-652	684-690	694-700	734-740	754-760
1587.5	----	1572.5-1602.5	1634.5-1640.5	1644.5-1650.5	1684.5-1690.5	1704.5-1710.5
	638	623-653	685-691	695-701	735-741	755-761
1588.5	----	1573.5-1603.5	1635.5-1641.5	1645.5-1651.5	1685.5-1691.5	1705.5-1711.5
	639	624-654	686-692	696-702	736-742	756-762
1589.5	----	1574.5-1604.5	1636.5-1642.5	1646.5-1652.5	1686.5-1692.5	1706.5-1712.5
	640	625-655	687-693	697-703	737-743	757-763
1590.5	----	1575.5-1605.5	1637.5-1643.5	1647.5-1653.5	1687.5-1693.5	1707.5-1713.5
	641	626-656	688-694	698-704	738-744	758-764
1591.5	----	1576.5-1606.5	1638.5-1644.5	1648.5-1654.5	1688.5-1694.5	1708.5-1714.5
	642	627-657	689-695	699-705	739-745	759-765
1592.5	----	1577.5-1607.5	1639.5-1645.5	1649.5-1655.5	1689.5-1695.5	1709.5-1715.5
	643	628-658	690-696	700-706	740-746	760-766
1593.5	----	1578.5-1608.5	1640.5-1646.5	1650.5-1656.5	1690.5-1696.5	1710.5-1716.5
	644	629-659	691-697	701-707	741-747	761-767
1594.5	----	1579.5-1609.5	1641.5-1647.5	1651.5-1657.5	1691.5-1697.5	1711.5-1717.5
	645	630-660	692-698	702-708	742-748	762-768
1595.5	----	1580.5-1610.5	1642.5-1648.5	1652.5-1658.5	1692.5-1698.5	1712.5-1718.5
	646	631-661	693-699	703-709	743-749	763-769
1596.5	----	1581.5-1611.5	1643.5-1649.5	1653.5-1659.5	1693.5-1699.5	1713.5-1719.5
	647	632-662	694-700	704-710	744-750	764-770
1597.5	----	1582.5-1612.5	1644.5-1650.5	1654.5-1660.5	1694.5-1700.5	1714.5-1720.5
	648	633-663	695-701	705-711	745-751	765-771
1598.5	----	1583.5-1613.5	1645.5-1651.5	1655.5-1661.5	1695.5-1701.5	1715.5-1721.5

AGO 10032A

High-band transmitter		Receiver channel/frequency				
Frequency	Channel	Required separation				
		-15 to +15	+50 (±3)	+60 (±3)	+100 (±3)	+120 (±3)
	649	634-664	696-702	706-712	746-752	766-772
1599.5	----	1584.5-1614.5	1646.5-1652 r	1656.5-1662.5	1696.5-1702.5	1716.5-1722.5
	650	635-665	697-703	707-713	747-753	767-773
1600.5	----	1585.5-1615.5	1647.5-1653.5	1657.5-1663.5	1697.5-1703.5	1717.5-1723.5
	651	636-666	698-704	708-714	748-754	768-774
1601.5	----	1586.5-1616.5	1648 6-1654.5	1658.5-1664.5	1698.5-1704.5	1718.5-1724.5
	652	637-667	699-705	709-715	749-755	769-775
1602.5	----	1587.5-1617.5	1649.5-1655.5	1659.5-1665.5	1699.5-1705.5	1719.5-1725.5
	653	638-668	700-706	710-716	750-756	770-776
1603.5	----	1588.5-1618.5	1650.5-1656.5	1660.5-1666.5	1700.5-1706.5	1720.5-1726.5
	654	639-669	701-707	711-717	751-757	771-777
1604.5	----	1589.5-1619.5	1651.5-1657.5	1661.5-1667.5	1701.5-1707.5	1721.5-1727.5
	655	640-670	702-708	712-718	752-758	772-778
1605.5	----	1590.5-1620.5	1652.5-1658.5	1662.5-1668.5	1702.5-1708.5	1722.5-1728.5
	656	641-671	703-709	713-719	753-759	773-779
1606.5	----	1591.5-1621.5	1653.5-1659.5	1663.5-1669.5	1703.5-1709.5	1723.5-1729.5
	657	642-672	704-710	714-720	754-760	774-780
1607.5	----	1592.5-1622.5	1654.5-1660.5	1664.5-1670.5	1704.5-1710.5	1724.5-1730.5
	658	643-673	705-711	715-721	755-761	775-781
1608.5	----	1593.5-1623.5	1655.5-1661.5	1665.5-1671.5	1705.5-1711.5	1725.5-1731.5
	659	644-674	706-712	716-722	756-762	776-782
1609.5	----	1594.5-1624.5	1656.5-1662.5	1666.5-1672.5	1706.5-1712.5	1726.5-1732.5
	660	645-675	707-713	717-723	757-763	777-783
1610.5	----	1595.5-1625.5	1657.5-1663.5	1667.5-1673.5	1707.5-1713.5	1727.5-1733.5
	661	646-676	708-714	718-704	758-764	778-784
1611.5	----	1596.5-1626.5	1658.5-1664.5	1668.5-1674.5	1708.5-1714.5	1728.5-1734.5
	662	647-677	709-715	719-725	759-765	779-785
1612.5	----	1597.5-1627.5	1659.5-1665.5	1669.5-1675.5	1709.5-1715.5	1729.5-1735.5
	663	648-678	710-716	720-726	760-766	780-786
1613.5	----	1598.5-1628.5	1660.5-1666.5	1670.5-1676.5	1710.5-1716.5	1730.5-1736.5
	664	649-679	711-717	721-727	761-767	781-787
1614.5	----	1599.5-1629.5	1661.5-1667.5	1671.5-1677.5	1711.5-1717.5	1731.5-1737.5
	665	650-680	712-718	722-728	762-768	782-788
1615.5	----	1600.5-1630.5	1662.5-1668.5	1672.5-1678.5	1712.5-1718.5	1732.5-1738.5
	666	651-681	713-719	723-729	763-769	783-789
1616.5	----	1601.5-1631.5	1663.5-1669.5	1673.5-1679.5	1713.5-1719.5	1733.5-1739.5
	667	652-682	714-720	724-730	764-770	784-790
1617.5	----	1602.5-1632.5	1664.5-1670.5	1674.5-1680.5	1714.5-1720.5	1734.5-1740.5
	668	653-683	715-721	725-731	765-771	785-791
1618.5	----	1603.5-1633.5	1665.5-1671.5	1675.5-1681.5	1715.5-1721.5	1735.5-1741.5
	669	654-684	716-722	726-732	766-772	786-792
1619.5	----	1604.5-1634.5	1666.5-1672.5	1676.5-1682.5	1716.5-1722.5	1736.5-1742.5
	670	655-685	717-723	727-733	767-773	787-793
1620.5	----	1605.5-1635.5	1667.5-1673.5	1677.5-1683.5	1717.5-1723.5	1737.5-1743 6
	671	656-686	718-724	728-734	768-774	788-794
1621.5	----	1606.5-1636.5	1668.5-1674.5	1678.5-1684.5	1718.5-1724.5	1738.5-1744.5
	672	657-687	719-725	729-735	769-775	789-795
1622.5	----	1607.5-1637.5	1669.5-1675.5	1679.5-1685.5	1719 6-1725.5	1739.5-1745.5
	673	658-688	720-726	730-736	770-776	790-796
1623.5	----	1608.5-1638.5	1670.5-1676.5	1680.5-1686.5	1720.5-1726.5	1741.5-1746.5
	674	659-689	721-727	731-737	771-777	791-797
1624.5	----	1609.5-1639.5	1671.5-1677.5	1681.5-1687.5	1721.5-1727.5	1741 6-1747.5
	675	660-690	722-728	732-738	772-778	792-798
1625.5	----	1610.5-1640.5	1672.5-1678.5	1682.5-1688.5	1722.5-1728.5	1742.5-1748.5

AGO 10032A

High-band transmitter		Receiver channel/frequency				
Frequency	Channel	Required separation				
		-15 to +15	+50 (±3)	+60 (±3)	+100 (±3)	+120 (±3)
	676	661-691	723-729	733-739	773-779	793-799
1626.5	----	1611.5-1641.5	1673.5-1679.5	16835-1689.5	1723.5-1729.5	1743.5-1749.5
	677	662-692	724-730	734-740	774-780	794-800
1627.5	----	1612.5-1642.5	1674.5-1680.5	1684.5-1690.5	1724.5-1730.5	1744.5-1750.5
	678	663-693	725-731	735-741	775-781	795-801
1628.5	----	1613.5-1643.5	1675.5-1681.5	1685.5-1691.5	1725.5-1731.5	1745.5-1751.5
	679	664-694	726-732	736-742	776-782	796-802
1629.5	----	1614.5-1644.5	1676.5-1682.5	1686.5-1692.5	1726.5-1732.5	1746.5-1752.5
	680	665-695	727-733	737-743	777-783	797-803
1630.5	----	1615.5-1645.5	1677.5-1683.5	1687.5-1693.5	1727.5-1733.5	1747.5-1753.5
	681	666-696	728-734	738-744	778-784	798-804
1631.5	----	1616.5-1646.5	1678.5-1684.5	1688.5-1694.5	1728.5-1734.5	1748.5-1754.5
	682	667-697	729-735	739-745	779-785	799-805
1632.5	----	1617.5-1647.5	1679.5-1685.5	1689.5-1695.5	1729.5-1735.5	1749.5-1755.5
	683	668-698	730-736	740-746	780-786	800-806
1633.5	----	1618.5-1648.5	1680.5-1686.5	1690.5-1696.5	1730.5-1736.5	1750.5-1756.5
	684	669-699	731-737	741-747	781-787	801-807
1634.5	----	1619.5-1649.5	1681.5-1687.5	1691.5-1697.5	1731.5-1737.5	1751.5-1757.5
	685	670-700	732-738	742-748	782-788	802-808
1635.5	----	1620.5-1650.5	1682.5-1688.5	1692.5-1698.5	1732.5-1738.5	1752.5-1758.5
	686	671-701	733-739	743-749	783-789	803-809
1636.5	----	1621.5-1651.5	1683.5-1689.5	1693.5-1699.5	1733.5-1739.5	1753.5-1759.5
	687	672-702	734-740	744-750	784-790	804-810
1637.5	----	1622.5-1652.5	1684.5-1690.5	1694.5-1700.5	1734.5-1740.5	1754.5-1760.5
	688	673-703	735-741	745-751	785-791	805-811
1638.5	----	1623.5-1653.5	1685.5-1691.5	1695.5-1701.5	1735.5-1741.5	1755.5-1761.5
	689	674-704	736-742	746-752	786-792	806-812
1639.5	----	1624.5-1654.5	1686.5-1692.5	1696.5-1702.5	1736.5-1742.5	1756.5-1762.5
	690	675-705	737-743	747-753	787-793	807-813
1640.5	----	1625.5-1655.5	1687.5-1693.5	1697.5-1703.5	1737.5-1743.5	1757.5-1763.5
	691	676-706	738-744	748-754	788-794	808-814
1641.5	----	1626.5-1656.5	1688.5-1694.5	1698.5-1704.5	1738.5-1744.5	1758.5-1764.5
	692	677-707	739-745	749-755	789-795	809-815
1642.5	----	1627.5-1657.5	1689.5-1695.5	1699.5-1705.5	1739.5-1745.5	1759.5-1765.5
	693	678-708	740-746	750-756	790-796	810-816
1643.5	----	1628.5-1658.5	1690.5-1696.5	1700.5-1706.5	1740.5-1746.5	1760.5-1766.5
	694	679-709	741-747	751-757	791-797	811-817
1644.5	----	1629.5-1659.5	1691.5-1697.5	1701.5-1707.5	1741.5-1747.5	1761.5-1767.5
	695	680-710	742-748	752-758	792-798	812-818
1645.5	----	1630.5-1860.5	1692.5-1698.5	1702.5-1708.5	1742.5-1748.5	1762.5-1768.5
	696	681-711	743-749	753-759	793-799	813-819
1646.5	----	1631.5-1661.5	1693.5-1699.5	1703.5-1709.5	1743.5-1749.5	1763.5-1769.5
	697	682-712	744-750	754-760	794-800	814-820
1647.5	----	1632.5-1662.5	1694.5-1700.5	1704.5-1710.5	1744.5-1750.5	1764.5-1770.5
	698	683-713	745-751	755-761	795-801	815-821
1648.5	----	1633.5-1663.5	1695.5-1701.5	1705.5-1711.5	1745.5-1751.5	1765.5-1771.5
	699	684-714	746-752	756-762	796-802	816-822
1649.5	----	1634.5-1664.5	1696.5-1702.5	1706.5-1712.5	1746.5-1752.5	1766.5-1772.5
	700	685-715	747-753	767-763	797-803	817-823
1650.5	----	1635.5-1665.5	1697.5-1703.5	1707.5-1713.5	1747.5-1753.5	1767.5-1773.5
	701	686-716	748-754	758-764	798-804	818-824
1651.5	----	1636.5-1666.5	1698.5-1704.5	1708.5-1714.5	1748.5-1754.5	1768.5-1774.5
	702	687-717	749-755	759-765	799-805	819-825
1652.5	----	1637.5-1667.5	1699.5-1705.5	1709.5-1715.5	1749.5-1755.5	1769.5-1775.5

AGO 10032A

High-band transmitter		Receiver channel/frequency				
Frequency	Channel	Required separation				
		-15 to +15	+50 (±3)	+60 (±3)	+100 (±3)	+120 (±3)
653.5	703	688-718	750-756	760-766	800-806	820-826
	----	1638.5-1668.5	1700.5-1706.5	1710.5-1716.5	1750.5-1756.5	1770.5-1776.5
	704	689-719	751-757	761-767	801-807	821-827
654.5	----	1639.5-1669.5	1701.5-1707.5	1711.5-1717.5	1751.5-1757.5	1771.5-1777.5
	705	690-720	752-758	762-768	802-808	822-828
655.5	----	1640.5-1670.5	1702.5-1708.5	1712.5-1718.5	1752.5-1758.5	1772.5-1778.5
	706	691-721	753-759	763-769	803-809	823-829
656.5	----	1641.5-1671.5	1703.5-1709.5	1713.5-1719.5	1753.5-1759.5	1773.5-1779.5
	707	692-722	754-760	764-770	804-810	824-830
657.5	----	1642.5-1672.5	1704.5-1710.5	1714.5-1720.5	1754.5-1760.5	1774.5-1780.5
	708	693-723	755-761	765-771	805-811	825-831
658.5	----	1643.5-1673.5	1705.5-1711.5	1715.5-1721.5	1755.5-1761.5	1775.5-1781.5
	709	694-724	756-762	766-772	806-812	826-832
655.5	----	1644.5-1674.5	1706.5-1712.5	1716.5-1722.5	1756.5-1762.5	1776.5-1782.5
	710	695-725	757-763	767-773	807-813	827-833
660.5	----	1645.5-1675.5	1707.5-1713.5	1717.5-1723.5	1757.5-1763.5	1777.5-1783.5
	711	696-726	758-764	768-774	808-814	828-834
661.5	----	1646.5-1676.5	1708.5-1714.5	1718.5-1724.5	1758.5-1764.5	1778.5-1784.5
	712	697-727	759-765	769-775	809-815	829-835
662.5	----	1647.5-1677.5	1709.5-1715.5	1719.5-1725.5	1759.5-1765.5	1779.5-1785.5
	713	698-728	760-766	770-776	810-816	830-836
663.5	----	1648.5-1678.5	1710.5-1716.5	1720.5-1726.5	1760.5-1766.5	1780.5-1786.5
	714	699-729	761-767	771-777	811-817	831-837
664.5	----	1649.5-1679.5	1711.5-1717.5	1721.5-1727.5	1761.5-1767.5	1781.5-1787.5
	715	700-730	762-768	772-778	812-818	832-838
665.5	----	1650.5-1680.5	1712.5-1718.5	1722.5-1728.5	1762.5-1768.5	1782.5-1788.5
	716	701-731	763-769	773-779	813-819	833-839
666.5	----	1651.5-1681.5	1713.5-1719.5	1723.5-1729.5	1763.5-1769.5	1783.5-1789.5
	717	702-732	764-770	774-780	814-820	834-840
667.5	----	1652.5-1682.5	1714.5-1720.5	1724.5-1730.5	1764.5-1770.5	1784.5-1790.5
	718	703-733	765-771	775-781	815-821	835-841
668.5	----	1653.5-1683.5	1715.5-1721.5	1725.5-1731.5	1765.5-1771.5	1785.5-1791.5
	719	704-734	766-772	776-782	816-822	836-842
669.5	----	1654.5-1684.5	1716.5-1722.5	1726.5-1732.5	1766.5-1772.5	1786.5-1792.5
	720	705-735	767-773	777-783	817-823	837-843
670.5	----	1655.5-1685.5	1717.5-1723.5	1727.5-1733.5	1767.5-1773.5	1787.5-1793.5
	721	706-736	768-774	778-784	818-824	838-844
671.5	----	1656.5-1686.5	1718.5-1724.5	1728.5-1734.5	1768.5-1774.5	1788.5-1794.5
	722	707-737	769-775	779-785	819-825	839-845
672.5	----	1657.5-1687.5	1719.5-1725.5	1729.5-1735.5	1769.5-1775.5	1789.5-1795.5
	723	708-738	770-776	780-786	820-826	840-846
673.5	----	1658.5-1688.5	1720.5-1726.5	1730.5-1736.5	1770.5-1776.5	1790.5-1796.5
	724	709-739	771-777	781-787	821-827	841-847
674.5	----	1659.5-1689.5	1721.5-1727.5	1731.5-1737.5	1771.5-1777.5	1791.5-1797.5
	725	710-740	772-778	782-788	822-828	842-848
675.5	----	1660.5-1690.5	1722.5-1728.5	1732.5-1738.5	1772.5-1778.5	1792.5-1798.5
	726	711-741	773-779	783-789	823-829	843-849
676.5	----	1661.5-1691.5	1723.5-1729.5	1733.5-1739.5	1773.5-1779.5	1793.5-1799.5
	727	712-742	774-780	784-790	824-830	844-850
677.5	----	1662.5-1692.5	1724.5-1730.5	1734.5-1740.5	1774.5-1780.5	1794.5-1800.5
	728	713-743	775-781	785-791	825-831	845-851
678.5	----	1663.5-1693.5	1725.5-1731.5	1735.5-1741.5	1775.5-1781.5	1795.5-1801.5
	729	714-744	776-782	786-792	826-832	846-852
679.5	----	1664.5-1694.5	1726.5-1732.5	1736.5-1742.5	1776.5-1782.5	1796.5-18402.5

AGO 10032A

High-band transmitter		Receiver channel/frequency				
Frequency	Channel	Required separation				
		-15 to +15	+50 (±3)	+60 (±3)	+100 (±3)	+120 (±3)
	730	715-745	777-783	787-793	827-833	847-853
1680.5	----	1665.5-1695.5	1727.5-1733.5	17375-1743.5	1777.5-1783.5	17975-1803.5
	731	716-746	778-784	788-794	828-834	848-854
1681.5	----	1666.5-1696.5	1728.5-1734.5	17385-1744.5	1778.5-1784.5	1798.5-1804.5
	732	717-747	779-785	789-795	829-835	849-855
1682.5	----	1667.5-1697.5	1729.5-1735.5	1739.5-1745.5	1779.5-1785.5	1799.5-1805.5
	733	718-748	780-786	790-796	830-836	850-856
1683.5	----	1668.5-1698.5	1730.5-1736.5	1740.5-1746.5	1780.5-1786.5	18005-1806.5
	734	719-749	781-787	791-797	831-837	851-857
1684.5	----	1669.5-1699.5	17315-1737.5	1741.5-1747.5	1781 S-1787.5	1801.5-1807.5
	735	720-750	782-788	792-798	832-838	852-858
1685.5	----	1670.5-1700.5	1732.5-1738.5	1742.5-1748.5	1782.5-1788.5	1802.5-1808.5
	736	721-751	783-789	793-799	833-839	853-859
1686.5	----	1671.5-1701.5	1733.5-1739.5	17435-1749.5	1783.5-1789.5	1803.5-1809.5
	737	722-752	784-790	794-800	834-840	854-860
1687.5	----	1672.5-1702.5	1734.5-1740.5	17445-1750.5	1784.5-1790.5	1804.5-1810.5
	738	723-753	785-791	795-801	835-841	855-861
1688.5	----	1673.5-1703.5	1735.5-1741.5	1745.5-1751.5	1785.5-1791.5	1805.5-1811.5
	739	724-754	786-792	796-802	836-842	856-862
1689.5	----	1674.5-1704.5	1736.5-1742.5	1746.5-1752.5	1786.5-1792.5	18065-1812.5
	740	725-755	787-793	797-803	837-843	857-863
16905	----	1675.5-1705.5	1737.5-1743.5	17475-1753.5	1787.5-1793.5	1807.5-1813.5
	741	726-756	788-794	798-804	838-844	858-864
1691.5	----	16765-1706.5	1738.5-1744.5	17485-1754.5	1788.5-1794.5	1808.5-1814.5
	742	727-757	789-795	799-805	839-845	859-865
1692.5	----	1677.5-1707.5	1739.5-1745.5	1749.5-1755.5	1789.5-1795.5	1809.5-1815.5
	743	728-758	790-796	800-806	840-846	860-866
1693.5	----	1678.5-1708.5	1740.5-1746.5	1750.5-1756.5	1790.5-1796.5	1810.5-1816.5
	744	729-759	791-797	801-807	841-847	861-867
1694.5	----	1679.5-1709.5	1741.5-1747.5	1751.5-1757.5	1791.5-1797.5	18115-1817.5
	745	730-760	792-798	802-808	842-848	862-868
1695.5	----	1680.5-1710.5	1742.5-1748.5	1752.5-1758.5	1792.5-1798.5	1812.5-1818.5
	746	731-761	793-799	803-809	843-849	863-869
1696.5	----	1681.5-1711.5	1743.5-1749.5	1753.5-1759.5	17935-1799.5	1813.5-1819.5
	747	732-762	794-800	804-810	844-850	864-870
1697.5	----	1682.5-1712.5	1744.5-1750.5	1754.5-1760.5	1794.5-1800.5	1814.5-1820.5
	748	733-763	795-801	805-811	845-851	865-871
1698.5	----	16835-1713.5	1745.5-1751.5	1755.5-1761.5	1795.5-1901.5	1815.5-1821.5
	749	734-764	796-802	806-812	846-852	866-872
1699.5	----	1684.5-1714.5	1746.5-1762.5	1756.5-1762.5	1796.5-1802.5	1816.5-1822.5
	750	735-765	797-803	807-813	847-853	867-873
1700.5	----	1685.5-1715.5	1747.5-1753.5	1757.5-1763.5	17975-1803.5	1817.5-1823.5
	751	736-766	798-804	808-814	848-854	868-874
1701.5	----	1686.5-1716.5	1748.5-1754.5	1758.5-1764.5	1798.5-1804.5	1818.5-1824.5
	752	737-767	799-805	809-815	849-855	869-875
1702.5	----	1687.5-1717.5	1749.5-1755.5	1759.5-1765.5	1799.5-1805.5	1819.5-1825.5
	753	738-768	800-806	810-816	850-856	870-876
1703.5	----	1688.5-1718.5	1750.5-1756.5	1760.5-1766.5	18005-1806.5	1820.5-1826.5
	754	739-769	801-807	811-817	851-857	871-877
1704.5	----	1689.5-1719.5	1751.5-1757.5	1761.5-1767.5	1801.5-1807.5	1821.5-1827.5
	755	740-770	802-808	812-818	852-858	872-878
1705.5	----	1690.5-1720.5	1752.5-1758.5	1762.5-1768.5	1802.5-1808.5	1822.5-1828.5
	756	741-771	803-809	813-819	853-859	873-879
1706.5	----	1691.5-1721.5	1753.5-1759.5	1763.5-1769.5	1803.5-1809.5	1823.5-1829.5

AGO 10032A

High-band transmitter		Receiver channel/frequency				
Frequency	Channel	Required separation				
		-15 to +15	+50 (±3)	+60 (±3)	+100 (±3)	+120 (±3)
	757	742-772	804-810	814-820	854-860	874-880
1707.5	-----	1692.5-1722.5	1754.5-1760.5	1764.5-1770.5	1804.5-1810.5	18245-1830.5
	758	743-773	805-811	815-821	855-861	875-881
1708.5	-----	1693.5-1723.5	1755.5-1761.5	1765.5-1771.5	1805.5-1811.5	1825.5-1831.5
	759	744-774	806-812	816-822	856-862	876-882
1709.5	-----	1694.5-1724.5	1756.5-1762.5	1766.5-1772.5	1806.5-1812.5	1826.5-1832.5
	760	745-775	807-813	817-823	857-863	877-883
1710.5	-----	1695.5-1725.5	1757.5-1763.5	1767.5-1773.5	1807.5-1813.5	1827.5-1833.5
	761	746-776	808-814	818-824	858-864	878-884
1711.5	-----	1696.5-1726.5	1758.5-1764.5	1768.5-1774.5	1808.5-1814.5	1828.5-1834.5
	762	747-777	809-815	819-825	859-865	879-885
1712.5	-----	1697.5-1727.5	1759.5-1765.5	1769.5-1775.5	1809.5-1815.5	1829.5-1835.5
	763	748-778	810-816	820-826	860-866	880-886
1713.5	-----	1698.5-1728.5	1760.5-1766.5	1770.5-1776.5	1810.5-1816.5	1830.5-1836.5
	764	749-779	811-817	821-827	861-867	881-887
1714.5	-----	1699.5-1729.5	1761.5-1767.5	1771.5-1777.5	1811.5-1817.5	1831.5-1837.5
	765	760-780	812-818	822-828	862-868	882-888
1715.5	-----	1700.5-1730.5	1762.5-1768.5	1772.5-1778.5	1812.5-1818.5	1832.5-1838.5
	766	751-781	813-819	823-829	863-869	883-889
1716.5	-----	1701.5-1731.5	1763.5-1769.5	1773.5-1779.5	1813.5-1819.5	1833.5-1839.5
	767	752-782	814-820	824-830	864-870	884-890
1717.5	-----	1702.5-1732.5	1764.5-1770.5	1774.5-1780.5	1814.5-1820.5	1834.5-1840.5
	768	753-783	815-821	825-831	865-871	885-891
1718.5	-----	1703.5-1733.5	1765.5-1771.5	1775.5-1781.5	1815.5-1821.5	1835.5-1841.5
	769	754-784	816-822	826-832	866-872	886-892
1719.5	-----	1704.5-1734.5	1766.5-1772.5	1776.5-1782.5	1816.5-1822.5	1836.5-1842.5
	770	755-785	817-823	827-833	867-873	887-893
1720.5	-----	1705.5-1735.5	1767.5-1773.5	1777.5-1783.5	1817.5-1823.5	1837.5-1843.5
	771	756-786	818-834	828-834	868-874	888-894
1721.5	-----	1706.5-1736.5	1768.5-1774.5	1778.5-1784.5	1818.5-1824.5	1838.5-1844.5
	772	757-787	819-825	829-835	869-875	889-895
1722.5	-----	1707.5-1737.5	1769.5-1775.5	1779.5-1785.5	1819.5-1825.5	1839.5-1845.5
	773	758-788	820-826	830-836	870-876	890-896
1723.5	-----	1708.5-1738.5	1770.5-1776.5	1780.5-1786.5	1820.5-1826.5	1840.5-1846.5
	774	759-789	821-827	831-837	871-877	891-897
1724.5	-----	1709.5-1739.5	1771.5-1777.5	1781.5-1787.5	1821.5-1827.5	1841.5-1847.5
	775	760-790	822-828	832-838	872-878	892-898
1725.5	-----	1710.5-1740.5	1772.5-1778.5	1782.5-1788.5	1822.5-1828.5	1842.5-1848.5
	776	761-791	823-829	833-839	873-879	893-899
1726.5	-----	1711.5-1741.5	1773.5-1779.5	1783.5-1789.5	1823.5-1829.5	1843.5-1849.5
	777	762-792	824-830	834-840	874-880	894-899
1727.5	-----	1712.5-1742.5	1774.5-1780.5	1784.5-1790.5	1824.5-1830.5	1844.5-1849.5
	778	763-793	825-831	835-841	875-881	895-899
1728.5	-----	1713.5-1743.5	1775.5-1781.5	1785.5-1791.5	1825.5-1831.5	1845.5-1849.5
	779	764-794	826-832	836-842	876-882	896-899
1729.5	-----	1714.5-1744.5	1776.5-1782.5	1786.5-1792.5	1826.5-1832.5	1846.5-1849.5
	780	765-795	827-833	837-843	877-883	897-899
1730.5	-----	1715.5-1745.5	1777.5-1783.5	1787.5-1793.5	1827.5-1833.5	1847.5-1849.5
	781	766-796	828-834	838-844	878-884	898-899
1731.5	-----	1716.5-1746.5	1778.5-1784.5	1788.5-1794.5	1828.5-1834.5	1848.5-1849.5
	782	767-797	829-835	839-845	879-885	-899
1732.5	-----	1717.5-1747.5	1779.5-1785.5	1789.5-1795.5	1829.5-1835.5	-1849.5
	783	768-798	830-836	840-846	880-886	
1733.5	-----	1718.5-1748.5	1780.5-1786.5	1790.5-1796.5	1830.5-1836.5	

AGO 10032A

High-band transmitter		Receiver channel/frequency				
Frequency	Channel	Required separation				
		-15 to +15	+50 (±3)	+60 (±3)	+100 (±3)	+120 (±3)
	784	769-799	831-837	841-847	881-887	
1734.5	----	1719.5-1749.5	1781.5-1787.5	1791.5-1797.5	1831.5-1837.5	
	785	770-800	832-838	842-848	882-888	
1735.5	----	1720.5-1750.5	1782.5-1788.5	1792.5-1798.5	1832.5-1838.5	
	786	771-801	833-839	843-849	883-889	
1736.5	----	1721.5-1751.5	1783.5-1789.5	1793.5-1799.5	1833.5-1839.5	
	787	772-802	834-840	844-850	884-890	
1737.5	----	1722.5-1752.5	1784.5-1790.5	1794.5-1800.5	1834.5-1840.5	
	788	773-803	835-841	845-851	885-891	
1738.5	----	1723.5-1753.5	1785.5-1791.5	1795.5-1801.5	1835.5-1841.5	
	789	774-804	836-842	846-852	886-892	
1739.5	----	1724.5-1754.5	1786.5-1792.5	1796.5-1802.5	1836.5-1842.5	
	790	775-805	837-843	847-853	887-893	
1740.5	----	1725.5-1756.5	1787.5-1793.5	1797.5-1803.5	1837.5-1843.5	
	791	776-806	838-844	848-854	888-894	
1741.5	----	1726.5-1756.5	1788.5-1794.5	1798.5-1804.5	1838.5-1844.5	
	792	777-807	839-845	849-855	889-895	
1742.5	----	1727.5-1757.5	1789.5-1795.5	1799.5-1805.5	1839.5-1845.5	
	793	778-808	840-846	850-856	890-896	
1743.5	----	1728.5-1758.5	1790.5-1796.5	1800.5-1806.5	1840.5-1846.5	
	794	779-809	841-847	851-857	891-897	
1744.5	----	1729.5-1759.5	1791.5-1797.5	1801.5-1807.5	1841.5-1847.5	
	796	780-810	842-848	862-868	892-898	
1745.5	----	1730.5-1760.5	1792.5-1798.5	1802.5-1808.5	1842.5-1848.5	
	796	781-811	843-849	853-859	893-899	
1746.5	----	1731.5-1761.5	1793.5-1799.5	1803.5-1809.5	1843.5-1849.5	
	797	782-812	844-850	854-860	894-899	
1747.5	----	1732.5-1762.5	1794.5-1800.5	1804.5-1810.5	1844.5-1849.5	
	798	783-813	845-851	855-861	895-899	
1748.5	----	1733.5-1763.5	1796.5-1801.5	1805.5-1811.5	1845.5-1849.5	
	799	784-814	846-862	856-862	896-899	
1749.5	----	1734.5-1764.5	1796.5-1802.5	1806.5-1812.5	1846.5-1849.5	
	800	785-815	847-853	857-863	897-899	
1750.5	----	1735.5-1765.5	1797.5-1803.5	1807.5-1813.5	1847.5-1849.5	
	801	786-816	848-854	858-864	898-899	
1751.5	----	1736.5-1766.5	1798.5-1804.5	1808.5-1814.5	1848.5-1849.5	
	802	787-817	849-855	859-865	-899	
1762.5	----	1737.5-1767.5	1799.5-1805.5	1809.5-1815.5	-1849.5	
	803	788-818	860-866	860-866		
1763.5	----	1738.5-1768.5	1800.5-1806.5	1810.5-1816.5		
	804	789-819	851-857	861-867		
1754.5	----	1739.5-1769.5	1801.5-1807.5	1811.5-1817.5		
	805	790-820	862-858	862-868		
1755.5	----	1740.5-1770.5	1802.5-1808.5	1812.5-1818.5		
	806	791-821	853-859	863-869		
1766.5	----	1741.5-1771.5	1803.5-1809.5	1813.5-1819.5		
	807	792-822	854-860	864-870		
1757.5	----	1742.5-1772.5	1804.5-1810.5	1814.5-1820.5		
	808	793-823	855-861	865-871		
1758.5	----	1743.5-1773.5	1805.5-1811.5	1816.5-1821.5		
	809	794-824	856-862	866-872		
1759.5	----	1744.5-1774.5	1806.5-1812.5	1816.5-1822.5		
	810	795-825	857-863	867-873		
1760.5	----	1746.5-1775.5	1807.5-1813.5	1817.5-1823.5		

AGO 10032A

High-band transmitter		Receiver channel/frequency				
Frequency	Channel	Required separation				
		-15 to +15	+50 (±3)	+60 (±3)	+100 (±3)	+120 (±3)
1761.5	811	796-826	858-864	868-874		
	----	1746.5-1776.5	1808.5-1814.5	1818.5-1824.5		
1762.5	812	797-827	869-865	869-876		
	----	1747.5-1777.5	1809.5-1815.5	1819.5-1825.5		
1763.5	813	798-828	860-866	870-876		
	----	1748.5-1778.5	1810.5-1816.5	1820.5-1826.5		
1764.5	814	799-829	861-867	871-877		
	----	1749.5-1779.5	1811.5-1817.5	1821.5-1827.5		
1765.5	815	800-830	862-868	872-878		
	----	1750.5-1780.5	1812.5-1818.5	1822.5-1828.5		
1766.5	816	801-831	863-869	873-879		
	----	1751.5-1781.5	1813.5-1819.5	1823.5-1829.5		
1767.5	817	802-832	864-870	874-880		
	----	1752.5-1782.5	1814.5-1820.5	1824.5-1830.5		
1768.5	818	803-833	865-871	875-881		
	----	1753.5-1783.5	1815.5-1821.5	1825.5-1831.5		
1769.5	819	804-834	866-872	876-882		
	----	1754.5-1784.5	1816.5-1822.5	1826.5-1832.5		
1770.5	820	805-836	867-873	877-883		
	----	1755.5-1785.5	1817.5-1823.6	1827.5-1833.5		
1771.5	821	806-836	868-874	878-884		
	----	1756.5-1786.5	1818.5-1824.5	1828.5-1834.5		
1772.5	822	807-837	869-875	879-885		
	----	1757.5-1787.5	1819.5-1825.5	1829.5-1835.5		
1773.5	823	808-838	870-876	880-886		
	----	1758.5-1788.5	1820.5-1826.5	1830.5-1836.5		
1774.5	824	809-839	871-877	881-887		
	----	1759.5-1789.5	1821.5-1827.5	1831.5-1837.5		
1775.5	825	810-840	872-878	882-888		
	----	1760.5-1790.5	1822.5-1828.5	1832.5-1838.5		
1776.5	826	811-841	873-879	883-889		
	----	1761.5-1791.5	1823.5-1829.5	1833.5-1839.5		
1777.5	827	812-842	874-880	884-890		
	----	1762.5-1792.5	1824.5-1830.5	1834.5-1840.5		
1778.5	828	813-843	875-881	885-891		
	----	1763.5-1793.5	1825.5-1831.5	1835.5-1841.5		
1779.5	829	814-844	876-882	886-892		
	----	1764.5-1794.5	1826.-1832.5	1836.5-1842.5		
1780.5	830	815-845	877-883	887-893		
	----	17655-1795.5	1827.5-1833.5	1837.5-1843.5		
1781.5	831	816-846	878-884	888-894		
	----	1766.5-1796.5	1828.5-1834.5	1838.5-1844.5		
1782.5	832	817-847	879-885	889-895		
	----	1767.5-1797.5	1829.5-1835.5	1839.5-1845.5		
1783.5	833	818-848	880-886	890-896		
	----	1768.5-1798.5	1830.5-1836.5	1840.5-1846.5		
1784.5	834	819-849	881-887	891-897		
	----	1769.5-1799.5	1831.5-1837.5	1841.5-1847.5		
1785.5	835	820-850	882-888	892-898		
	----	1770.5-1800.5	1832.5-1838.5	1842.5-1848.5		
1786.5	836	821-851	883-889	893-899		
	----	1771.5-1801.5	1833.5-1839.5	1843.5-1849.5		
1787.5	837	822-852	884-890	894-899		
	----	1772.5-1802.5	1834.5-1840.5	1844.5-1849.5		

AGO 10032A

High-band transmitter		Receiver channel/frequency				
Frequency	Channel	Required separation				
		-15 to +15	+50 (±3)	+60 (±3)	+100 (±3)	+120 (±3)
1788.5	838 -----	823--853 1773.5-1803.5	885-891 1835.5-1841.5	895-899 1845.6-1849.5		
1789.5	839 -----	824-854 1774.5-1804.5	886-892 1836.5-1842.5	896-899 1846.5-1849.5		
1790.5	840 -----	825-855 1775.5-1805.5	887-893 1837.5-1843.5	897-899 1847.5-1849.5		
1791.5	841 -----	826-856 1776.5-1806.5	888-894 1838.5-1844.5	898-899 1848.5-1849.5		
1792.5	842 -----	827-857 1777.5-1807.5	889-895 1839.5-1845.5	-899 -1849.5		
1793.5	843 -----	828-858 1778.5-1808.5	890-896 1840.5-1846.5			
1794.5	844 -----	829-859 1779.5-1809.5	891-897 1841.5-1847.5			
1795.5	845 -----	830-860 1780.5-1810.5	892-898 1842.5-1848.5			
1796.5	846 -----	831-861 1781.5-1811.5	893-899 1843.5-1849.5			
1797.5	847 -----	832-862 1782.5-1812.5	894-899 1844.5-1849.5			
1798.5	848 -----	833-863 1783.5-1813.5	895-899 1845.5-1849.5			
1799.5	849 -----	834-864 1784.5-1814.5	896-899 1846.5-1849.5			
1800.5	850 -----	835-865 1785.5-1815.5	897-899 1847.5-1849.5			
1801.5	851 -----	836-866 1786.5-1816.5	898-899 1848.5-1849.5			
1802.5	852 -----	837-867 1787.5-1817.5	-899 -1849.5			
1803.5	853 -----	838-868 1788.5-1818.5				
1804.5	864 -----	839-869 1789.5-1819.5				
1805.5	855 -----	840-870 1790.5-1820.5				
1806.5	856 -----	841-871 1791.5-1821.5				
1807.5	867 -----	842-872 1792.5-1822.5				
1808.5	858 -----	843-873 1793.5-1823.5				
1809.5	859 -----	844-874 1794.5-1824.5				
1810.5	860 -----	846-875 1795.5-1825.5				
1811.5	861 -----	846-876 1796.5-1826.5				
1812.5	862 -----	847-877 1797.5-1827.5				
1813.5	863 -----	848-878 1798.5-1828.5				
1814.5	864 -----	849-879 1799.5-1829.5				

AGO 10032A

High-band transmitter		Receiver channel/frequency				
Frequency	Channel	Required separation				
		-15 to +15	+50 (±3)	+60 (±3)	+100 (±3)	+120 (±3)
1815.5	865	850-880				
		1800.5-1830.5				
	866	851-881				
1816.5		1801.5-1831.5				
	867	852-882				
1817.5		1802.5-1832.5				
	868	853-883				
1818.5		1803.5-1833.5				
	869	854-884				
1819.5		1804.5-1834.5				
	870	855-885				
1820.5		1805.5-1835.5				
	871	856-886				
1821.5		1806.5-1836.5				
	872	857-887				
1822.5		1807.5-1837.5				
	873	858-888				
1823.5		1808.5-1838.5				
	874	859-889				
1824.5		1809.5-1839.5				
	875	860-890				
1825.5		1810.5-1840.5				
	876	861-891				
1826.5		1811.5-1841.5				
	877	862-892				
1827.5		1812.5-1842.5				
	878	863-893				
1828.5		1813.5-1843.5				
	879	864-894				
1829.5		1814.5-1844.5				
	880	865-895				
1830.5		1815.5-1845.5				
	881	866-896				
1831.5		1816.5-1846.5				
	882	867-897				
1832.5		1817.5-1847.5				
	883	868-898				
1833.5		1818.5-1848.5				
	884	869-899				
1834.5		1819.5-1849.5				
	885	870-899				
1835.5		1820.5-1849.5				
	886	871-899				
1836.5		1821.5-1849.5				
	887	872-899				
1837.5		1822.5-1849.5				
	888	873-899				
1838.5		1823.5-1849.5				
	889	874-899				
1839.5		1824.5-1849				
	890	875-899				
1840.5		1825.5-1849.5				
	891	876-899				
1841.5		1826.5-1849.5				

High-band transmitter		Receiver channel/frequency				
Frequency	Channel	Required separation				
		-15 to +15	+50 (+3)	+60 (+3)	+100 (+3)	+120 (+3)
1842.5	892	877-899				
		1827.5-1849.5				
1843.5	896	878-899				
		1828.5-1849.5				
1844.5	894	879-899				
		1829.5-1849.5				
1845.5	895	880-899				
		1830.5-1849.5				
1846.5	896	881-899				
		1831.5-1849.5				
1847.5	897	882-899				
		1832.5-1849.5				
1848.5	898	883-899				
		1833.5-1849.5				
1849.5	899	884-899				
		1834.5-1849.5				

2-4. Shelter Requirements

The shelter used to house the radio set when it is to be installed without the use of a supplied shelter should provide the following:

- a. Protection from bad weather.
- b. A dry, secure mounting, free from vibration, that furnishes support for the equipment in a level position.
- c. Sufficient space for satisfactory maintenance and operation of the equipment.
- d. Adequate lighting for day and night operations with the front panel markings easily recognizable.
- e. A floorspace approximately 2 feet by 2 feet and a minimum ceiling height of 3 feet to allow for stack mounting the equipment.
- f. A power source of 115 volts \pm 17 percent, 47 to 63 cps, 12 amperes, for each radio set stack.

2-5. Tools Required for Installation

The installation of the radio set does not require the use of any special tools or test equipment. All necessary tools are supplied in the accessory case.

a. The following tools are required for the installation of transmitter, and receiver. Some are included with the radio sets (app B).

- (1) 5/16-inch socket wrench.
- (2) 7/16-inch socket wrench.
- (3) 4-inch screwdriver.
- (4) 2-1/2-inch screwdriver.

b. The tools with Mast AB-577/GRC for installation of the AT-903/G include the following:

- (1) Spanner wrench.
- (2) Mast-section clamp tool.
- (3) Sledge hammer.
- (4) Chisel-joint digging bar.

2-6. Antenna Site
 The antenna site should be large enough for adequate installation and be reasonably flat and clear of obstructions. The maximum separation between Mast AB-577/GRC and the shelter should not be more than 60 feet. The antenna components are shown in figures 1-7 and 1-8. The MK-806/GRC is not supplied with the radio sets. It may be obtained and installed with the AB-577/GRC to raise AT-903/G to 76 feet.

2-7. Antenna AT-903/G Adjustment

a. Antenna AT-903/G (fig. 1-7) is provided with a removable three-legged mounting frame which is used to position the horn for either horizontal or vertical polarization. This mounting frame may be detached from the AT-903/G by pulling the rings of the three ball-lock pins that secure the mounting frame legs to the horizontal or vertical polarization mounting lugs on the horn. The mounting frame is attached to the horn for either type of polarization by aligning the holes in the legs of the mounting frame with the holes in the horn

mounting lugs. Set the ball-lock pins until the ball locks have passed through the holes and are visible. The ball-lock pins should then be pulled back without the use of the release rings to make sure that the lock mechanism works. B. figure 1-7 illustrates the horn position for vertical polarization, and A illustrates the horn position for horizontal polarization. An arrow is painted on some antennas to indicate the horn polarity with respect to the horizon.

b. To install Antenna AT-903/G and Mast AB-577/GRC, refer to TM 11-5820-538-12.

2-8. Cable Connections and Grounding

a. *Cable Connections.* Refer to figure 6- for typical cable connections between the components of the radio set. The illustration also shows the cable connections for associated telephone carrier terminal or repeater station equipment.

b. *Grounding.* Use heavy gage, Insulated wire or ground straps to connect the GRD binding post on Power Supply PP-2054(*)/GRC to an earth grounding facility.

c. *PCM Operation.* After all the radio lends have been satisfactorily lined up (pare 3-16), the video transmission signal cable of the pcm equipment is connected to the PCM IN receptacle on the T-893(P)/GRC and the order-wire cable Is connected to the PCM ORDER WIRE connector. Connect the receiver signal cable of the pcm equipment to the PCM OUT receptacle on the receiver.

d. *Fdm Operation.*

- (1) Connect the spiral-four cable from the pcm equipment to the FDM CABLE CONNECTIONS binding posts.
- (2) Set the FDM OUTPUT TRAFFIC CHAN switch according to the type of carrier terminal equipment (4- or 12/24-channel equipment).

2-9. Wavemeter Vernier Scale Interpretation

(fig. 2-2)

To set the wavemeter, special procedures must be followed because of the intricate interpretation of the wavemeter vernier scale. Remove the wavemeter chart from its slot in either the amplifier-converter or the amplifier-oscillator. Determine the wavemeter setting by looking up the channel number to be used In the CHN column of the chart. When the transmitter is being tuned, use either the dial setting in the MAIN TUNE or OUT FREQ. columns as stated in the procedures; when the receiver is being tuned, use the dial setting in the REC. OSC. column. For example: when a setting of 961.7 is required according to the wavemeter chart, the wavemeter adjustment procedures are given in a through e below:

a. Assume that a setting corresponding to 961.7 is desired.

CAUTION

To prevent damage to the wavemeter main dial assembly, tune slowly and avoid forcing main dial against end stop.

b. Rotate the main dial knob until the number 9 on the hundreds (drum window) is directly under the index line.

c. Again rotate the main dial knob clockwise until the 61 gradation (line) on the units scale IS directly under the zero hne on the vernier scale.

d. Continue turning the main dial slowly clockwise until the seven-tenths gradation on the vernier scale exactly coincides with a gradation on the units scale.

e. Reading the dial is the reverse of inserting a setting. A gradation on the vernier scale, counterclockwise from the zero line, which coincides with a gradation on the units scale Is the dial setting In tenths; the units gradation under, or to the right of, the zero line is the dial setting In units; and the number on the hundreds (drum window) under the index line is the dial setting in hundreds.

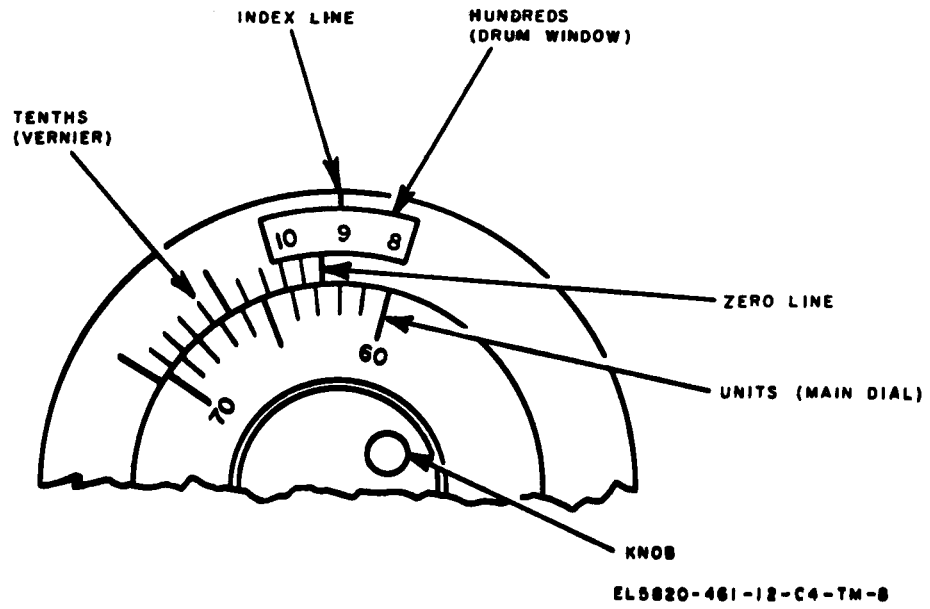

**CHAPTER 3
OPERATING INSTRUCTIONS**

Section I. OPERATOR'S CONTROLS AND INDICATORS

Note. This section covers only Items used by the operator, Items used by higher category maintenance personnel are covered in instructions for the appropriate maintenance category

Caution: To avoid receiver crystal damage, the REC SIG-1 and OSCILLATOR controls (in the receiver) and the REC SIG-2 control (in the transmitter) should not be tuned closer than 15 channels to the MAIN TUNING, POWER CUT, and COUPLING controls settings (in the transmitter).

3-1. Transmitter Controls and Indicators

a. *General.* The complete transmitter consists of Transmitter, Radio T-893(P)/GRC, Amplifier-Oscillator AM-1 957/GRC, Amplifier-Oscillator AM-1958(*)/GRC, and Power Supply PP-2054(*)/GRC. The controls and indicators are listed in b and c below.

b. *Transmitter, Radio T -98(P)/GRC, and Amplifier-Oscillators AM-1957/GRC and AM-1858(*)/GRC: (figs. 3-1, 3-2, and 3-3).* The operating controls and indicators in the following chart are common to the AM-1957/GRC and AM-1958(*)/GRC, unless otherwise noted. The AM-1957/GRC is plugged into the T-893(P)/GRC when the low-band transmitting frequencies are used, and the AM-1958(*)/GRC is plugged in when the high-band transmitting frequencies are used.

Control or indicator	Function
ARC selector switch (fig. 3-1).....	<i>sw pos</i> <i>Function</i> TUNE-----Disables arc for tuning. ODD-----Sets arc motor for use on odd-numbered channels (1, 3, 5, etc). EVEN-----Set arc motor for use on even-numbered channels (2, 4, 6, etc)
AFC CORRECTION control	Checks arc system Physical position of control (with respect to center position) indicates relative amount and polarity of afc correction voltage.
AFC LEVEL control.....	Adjusts arc signal level.
AFC meter.....	Indicates arc tuning error.
INPUT LEVELS PCM control	Sets the Input signal level of the pcm amplifier for proper amplitude at modulator. The inputs are lowered as the control is turned toward the LO position and raised as the control is turned toward the HI position.
INPUT LEVELS FDM control.....	Sets the input signal level of the fdm amplifier for proper amplitude at modulator. The inputs are lowered as the control is turned toward the LO position and raised as the control is turned toward the HI position.
INPUT LEVELS TRAFFIC CHAN switch (for FDM only).	Switches input impedance from 600 ohms (for four-channel operation) to 135 ohms (for 12/24-channel operation).

Control or indicator	Function
BUZ OFF button	Silences alarm buzzer.
ALARM ADJ control (screwdriver adjustment)	Sets power level at which alarm buzzer will ring.
LOW POWER indicator	When lighted, indicates that the transmitter is operating below the predetermined power output level
Multimeter selector switch.....	<p><i>Sw pos Causes meter to read</i></p> OFF (TRANSIT) Protects multimeter during transit OSC Oscillator cathode current. MAIN TUNE Oscillator signal level MIXER Mixer cathode voltage. AMP Amplifier output voltage. OUT FREQ Transmitter output voltage. PWR OUT Output power to the antenna. REF PWR Reflected power from the antenna. AFC LEV Afc if signal level. 1 KC IN Fdm multiplex signal input. 68 KC IN Fdm multiplex tone signal. 1 KC MOD Local signal output of modulator (test tone). 68 KC MOD Local signal output of modulator, generated by multiplex equipment. PCM IN Amplitude of pcm pulses at input to modulator. TEST External signal applied to test jacks.
Multimeter	Indicates the output of the circuit selected by the multimeter selector switch.
METER SHUNT button	Decreases meter sensitivity when multimeter reading goes off scale.
AFC TUNE control	Tunes T 893(P)IGRC cavity to desired channel frequency.
AFC TUNE CHANNEL indicator	Indicates selected channel
MAIN TUNING (figs 3-2 and 3 3):	
Control.....	Roughly tunes oscillator mixer, and power amplifier to selected channel.
Indicator.....	Indicates selected channel
MIXER control	Tunes mixer plate circuit to frequency of selected channel.
AMP control.....	Tunes power amplifier plate circuit to frequency of selected channel
WAVEMETER control.....	Adjusts wavemeter cavity.
WAVEMETER CHART.....	Table of calibrated wavemeter settings.
COUPLING control	Adjusts output coupling from power amplifier to antenna circuit
POWER OUT control.....	Tunes transmitter section of duplexer
TRANSMIT CHANNEL indicator	Indicates selected channel when transmitter section of duplexer is tuned by the POWER OUT control
REC SIG-2 control.....	Tunes receiver section of duplexer.
RECEIVE CHANNEL indicator	Indicates selected channel when receiver section of duplexes is tuned by the REC SIG-2 control.
OSC control (AM-1958(*)/GRC only).....	Tunes oscillator to selected channel frequency

c. *Power Supply PP-2054 (*)/GRC (fig. 3-4).*

Control or indicator	Function
AC POWER circuit breaker.....	Turns transmitter ac power on and off. Also serves as circuit breaker to automatically turn transmitter off if overload occurs.
OPERATE-STAND BY switch	Applies high voltage to transmitter in OPERATE position.
FIL indicator	When lighted, indicates that 116 volts ac is applied to primary of filament transformer.
LV indicator	When lighted, indicates that 115 volts ac is applied to primary of low voltage transformer
HV indicator.....	When lighted, indicates that 115 volts ac is applied to primary of high voltage transformer.

3-2. Receiver Controls and Indicators

a. *General.* The receiver consists of Receiver, Radio R-1148(P)/GRC or Receiver, Radio R-1331(*) (P)/GRC7 and Amplifier Converter AM-1955(*)/GRC or Amplifier Converter AM-1956(*)/GRC.

Note. In an emergency, the AM-1955A/GRC and AM-195fiA/GRC may be used in the R-1148(P)/GRC

b. *Receivers, Radio R- 1148(P)/GRC and R-1881(*) (P)/GRC* (figs. 3-5 and 3-6).

Control or indicator	Function
SQUELCH INCR SENS control.....	Sets level of squelch alarm.
SQUELCH NO SIGNAL indicator.....	When lighted, indicates receiver signal Input IS below predetermined level.
SQUELCH BUZZER OFF button.....	Silences alarm buzzer.
FDM OUTPUT LEVEL control.....	Adjusts fdm output level.
FDM OUTPUT TRAFFIC CHAN switch	Switches input impedance from 600 ohms (for four-channel operation) to 135 ohms (for 12/24-channel operation).
Multimeter selector switch:	<i>Sw pos</i> Causes meter to read. OFF (TRANSIT) Protects multimeter during transit. OSC Oscillator output voltage. AFC LEV ^a Afc signal output level. REC SIGNAL Signal output level of receiver. TEST TONE CAL Test tone level (when TEST TONE ON-OFF switch is on the ON position). ORDER WIRE Order-wire signal level output. 1 KC OUT Fdm output pulses (1-kc test tone) 68 KC OUT Fdm output pulses (68 kc). PCM OUT Pcm output pulses. TEST External signal applied to test jacks.
Multimeter	Indicates the output of the circuit selected by the multimeter selector switch.
INCOMING CALL indicator.....	When lighted, indicates reception of 1,600-cps ring signal
RING button	Activates 1,600 cps oscillator for signaling on order wire.
TEST TONE ON-OFF switch.....	Turns test tone signal on or off.
TEST TONE adjust control.....	Adjusts test tone signal level.
AFC meter ^a	Indicates afc tuning error.
AFC selector switch ^a	<i>Sw</i> Function TUNE disables afc for tuning. ODD Sets afc motor for use on odd-numbered channels. EVEN Sets arc motor for use on even-numbered channels
AFC LEVEL control ^a	Sets afc level.
AFC TUNE control ^a	Tunes the R-1148(P)/GRC arc cavity to desired frequency
AFC TUNE CHANNEL indicator ^a	Indicates selected channel number
AC POWER ON-OFF switch.....	Turns receiver on and off.
AC POWER indicator	When lighted, indicates 115 volts ac is applied to power transformer primary.
AFC DISABLE (R-1331(*) (P)/GRC only)	Disables afc during tuneup.

^a These controls are not Dart of Receiver. Radio R-1331P)/GRC

c. *Amplifier-Converter AM-1955(*)/GRC and Amplifier-Converter AM-1956(*)/GRC* (fig. 3-7). The operating controls and indicators listed in the following chart are common to the AM-1955(*)/GRC and AM-1956(*)/GRC, except where indicated. The AM-1955/GRC is plugged into R-1148(P)/GRC and the AM-1955A/GRC into the R-1331(*) (P)/GRC when the low-band frequencies are to be received, and the AM-1956/GRC is plugged into the R-1148(P)/GRC and the AM-1955A/GRC into the R-1331(*) (P)/GRC when the high-band frequencies are to be received. With the exception of the nameplate and AFC control on the front panel, the AM-1956/GRC is functionally

identical with the AM-1955/GRC, and the AM-1956A/GRC is functionally identical with the AM-1955A/GRC.

Note. In an emergency, the AM-1955A/GRC and AM-1956A/GRC may be used in the R-1148(P)/GRC. In this situation use of afc operations are changed as indicated in the tuning procedures

Control or indicator	Function
WAVEMETER control	Sets wavemeter to desired frequency.
WAVEMETER CHART	Table of calibrated frequency settings for wavemeter.
AFC correction control ^a	Checks afc system. Physical position of control (in respect to center position) indicates relative amount and polarity of afc correction voltage.
REC SIG-1	Tunes the amplifier-converter to desired channel
OSCILLATOR	Tunes local oscillator to desired frequency.

^a This control is not part of Amplifier-Converter AM-1955A/GRC or Amplifier-Converter AM-1956A/GRC.

3-3. Regulator, Voltage C-514/GRC, Controls and Indicators
(fig. 3-8)

Control or indicator	Function
MANUAL indicator	When lighted, indicates MANUAL-AUTOMATIC switch is in MANUAL position.
MANUAL RAISE-LOWER switch	Controls the regulator circuits from manually raise or lower the 115-volt power source input
MANUAL-AUTOMATIC switch	Switches the regulator circuits from manual to automatic control.
REGULATED OUTPUT VOTAGE meter.	Indicates the regulated output voltage
POWER switch.....	Turns voltage regulator ac power on and off. Also serves as circuit breaker to automatically turn ac power off if overload occurs.
POWER ON indicator	When lighted, indicates POWER switch is in ON position.

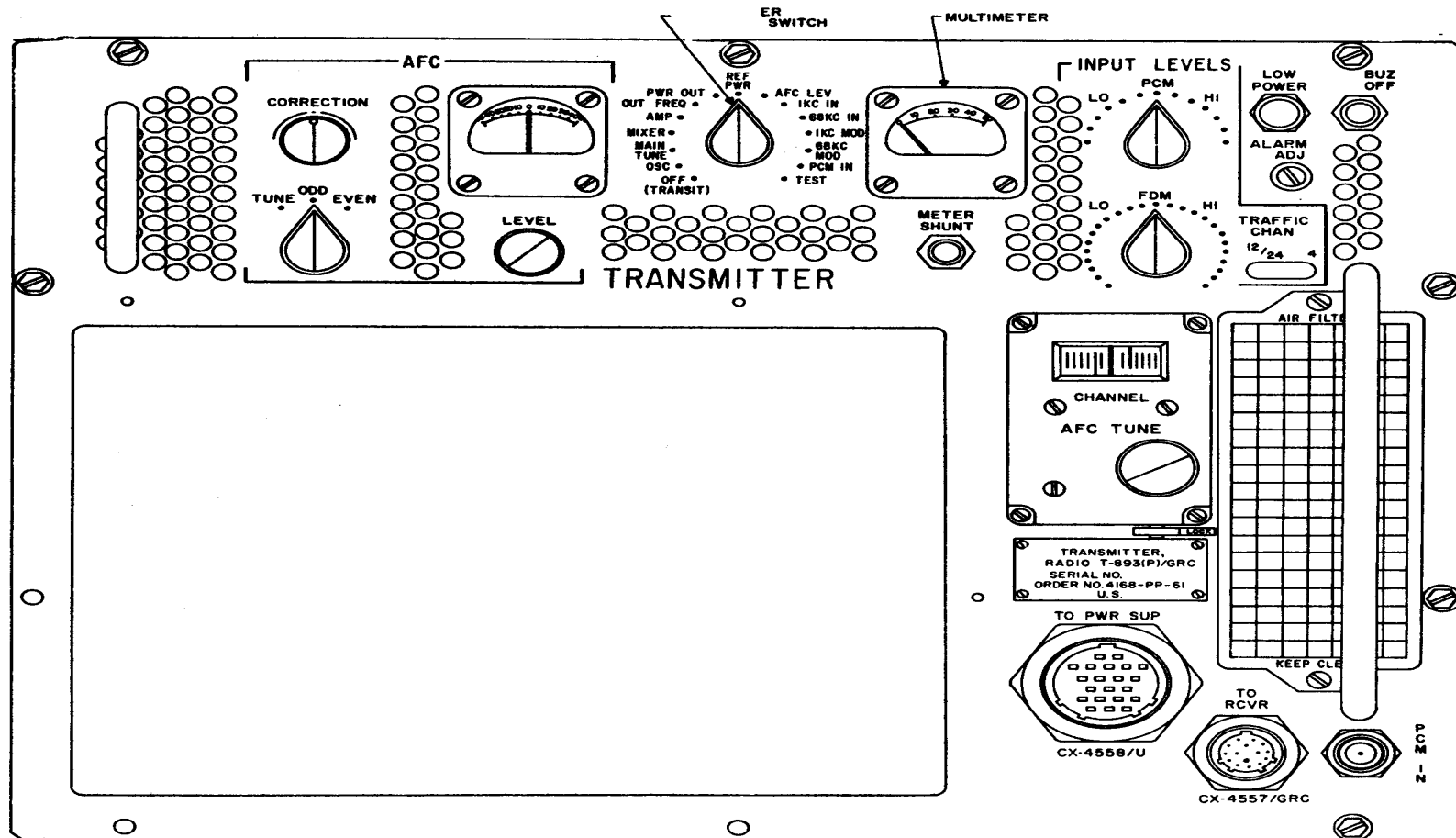

TM5820-461-12-16

Figure 3-1. Transmitter, Radio T-893(P)/GRc, front panel view

Change 4 3-5

CAUTION
 TO PREVENT DAMAGE TO THE WAVEMETER
 DIAL ASSEMBLY, TUNE SLOWLY AND AVOID
 FORCING DIAL AGAINST END STOPS.

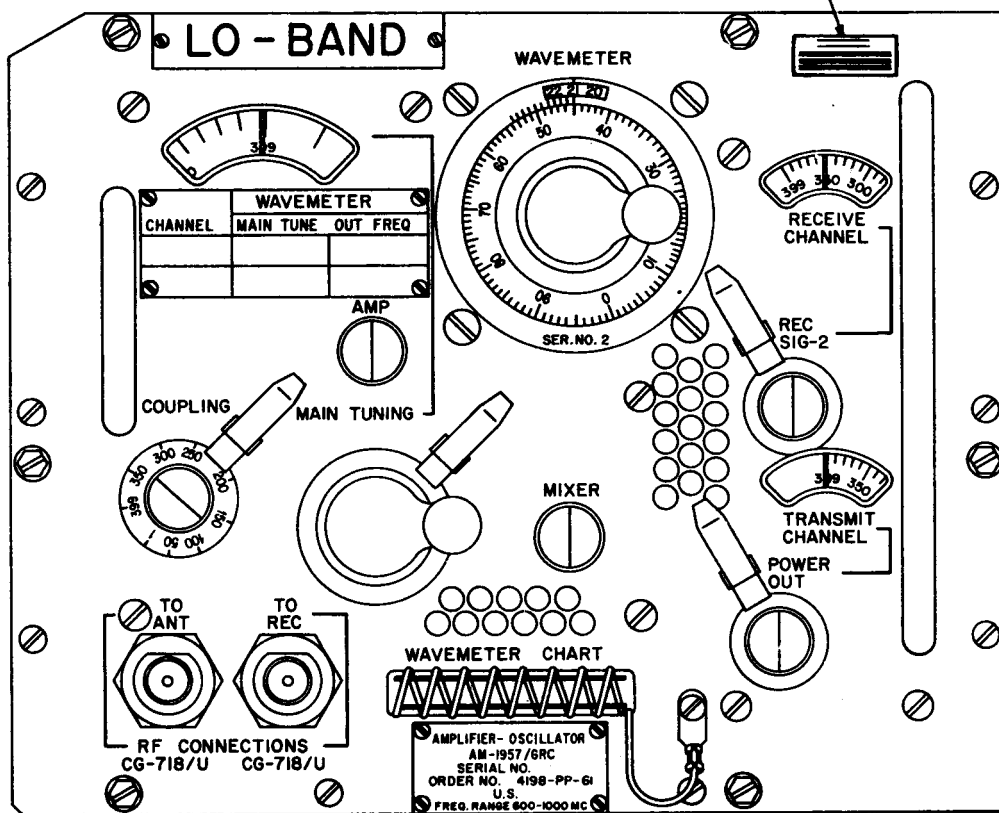

EL5820-461-12-C4-TM-9

Figure 3-2. Amplifier-Oscillator AM-1957/GRC, front panel view.

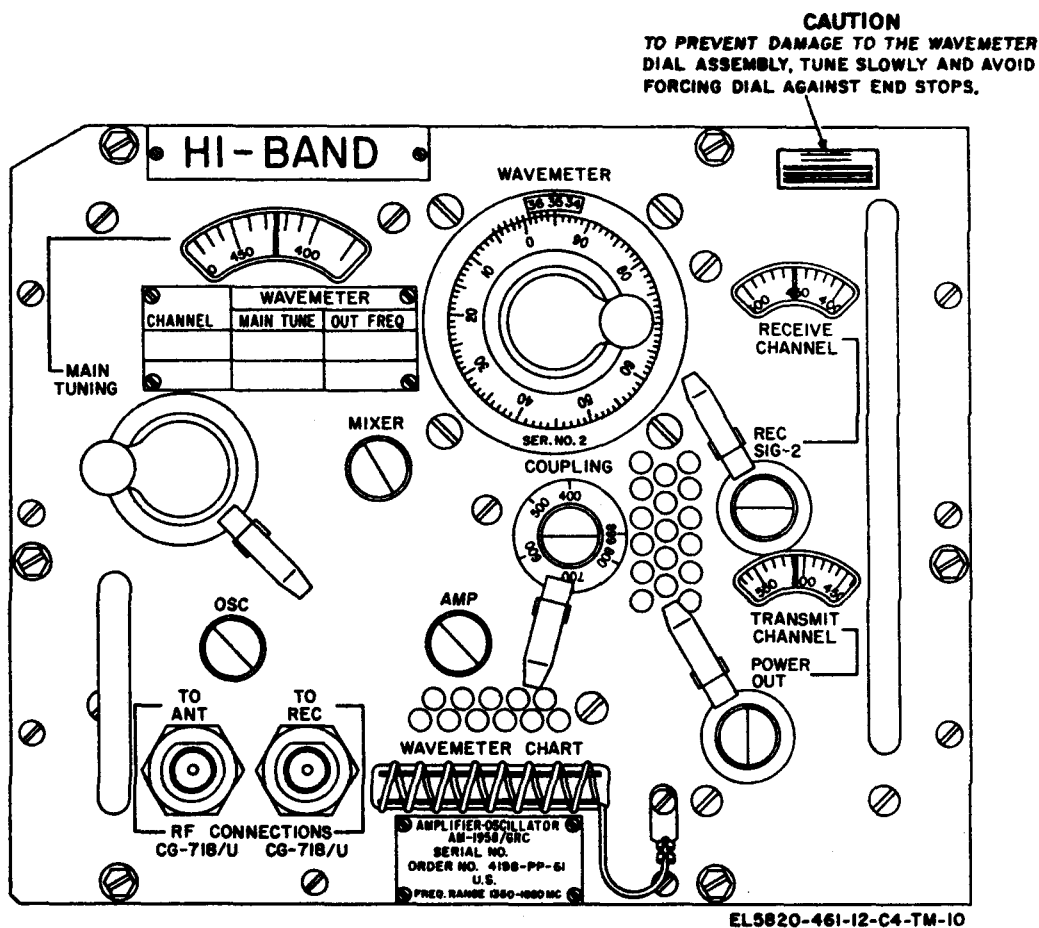

Figure 3-3. Amplifier-oscillator AM-1958/GRC, front panel view.

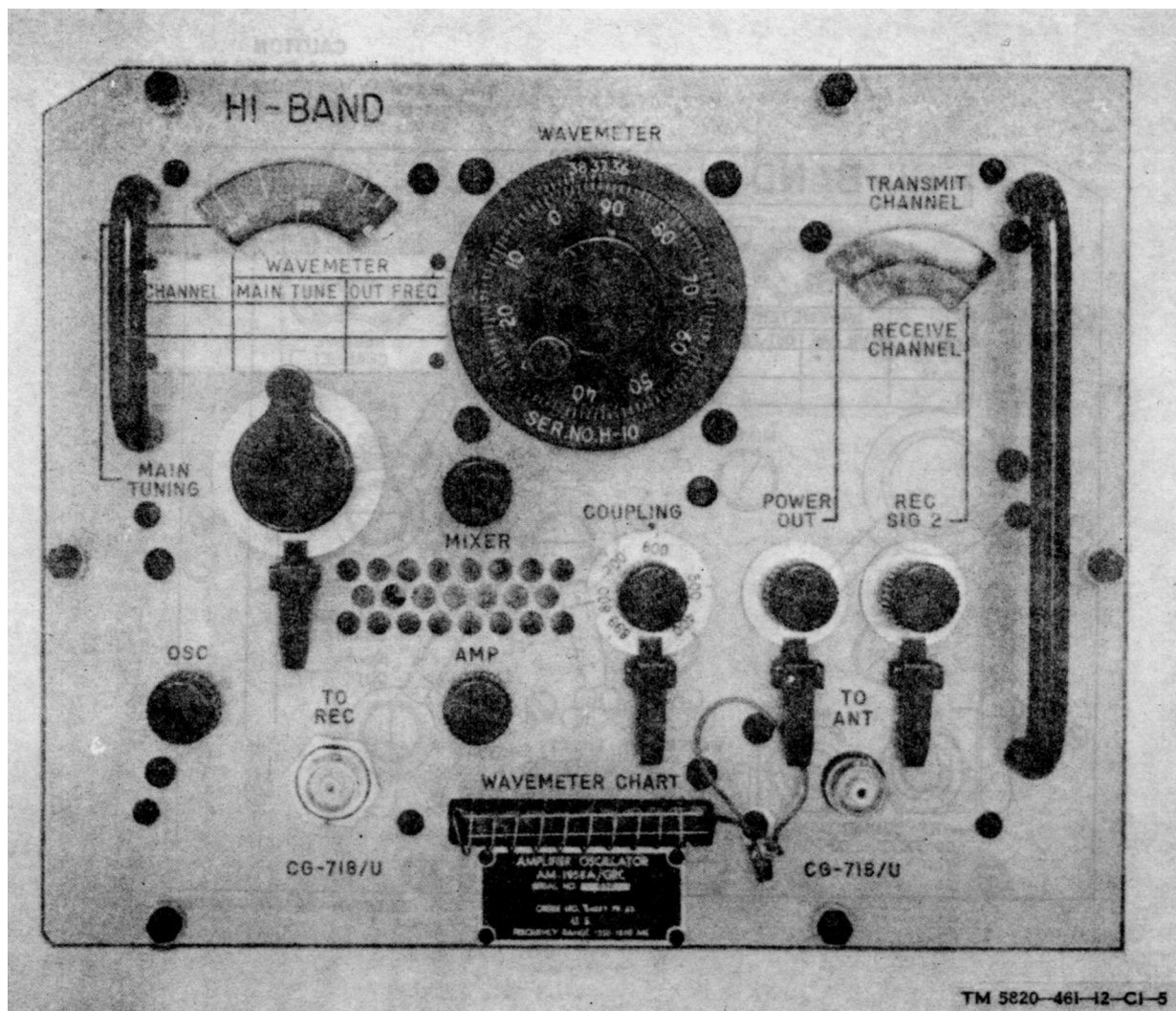

Figure 3-3.1. Amplifier-Oscillator AM-1958A/GRC, front panel view.

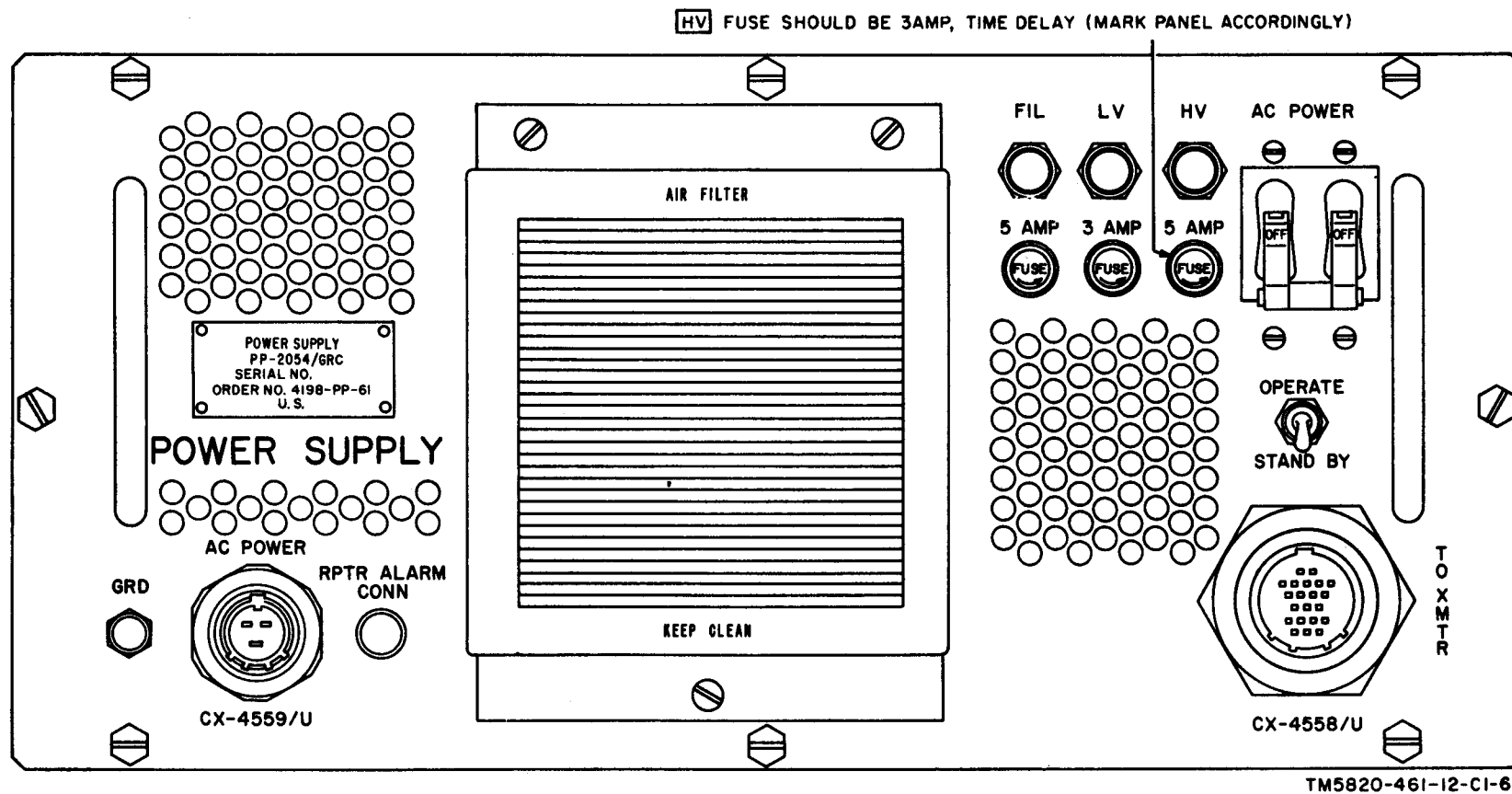
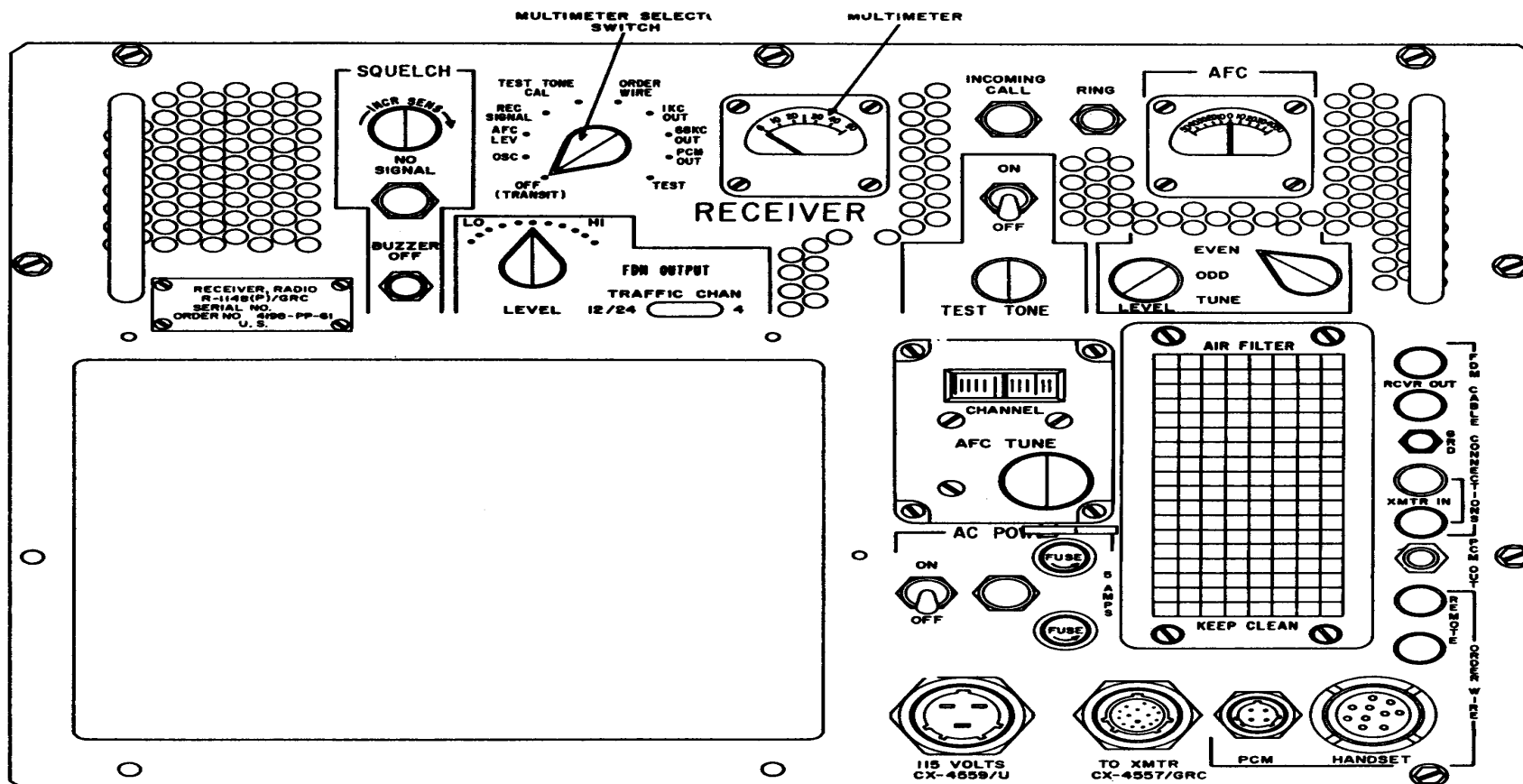

Figure 3-4. Power Supply PP-2054(*)/GRC, front panel view

Change 4 3-8.1



TM5820-461-10-20

Figure 3-5. Receiver Radio R-1148(P)/GRC, front panel view.

Change 4 3-9

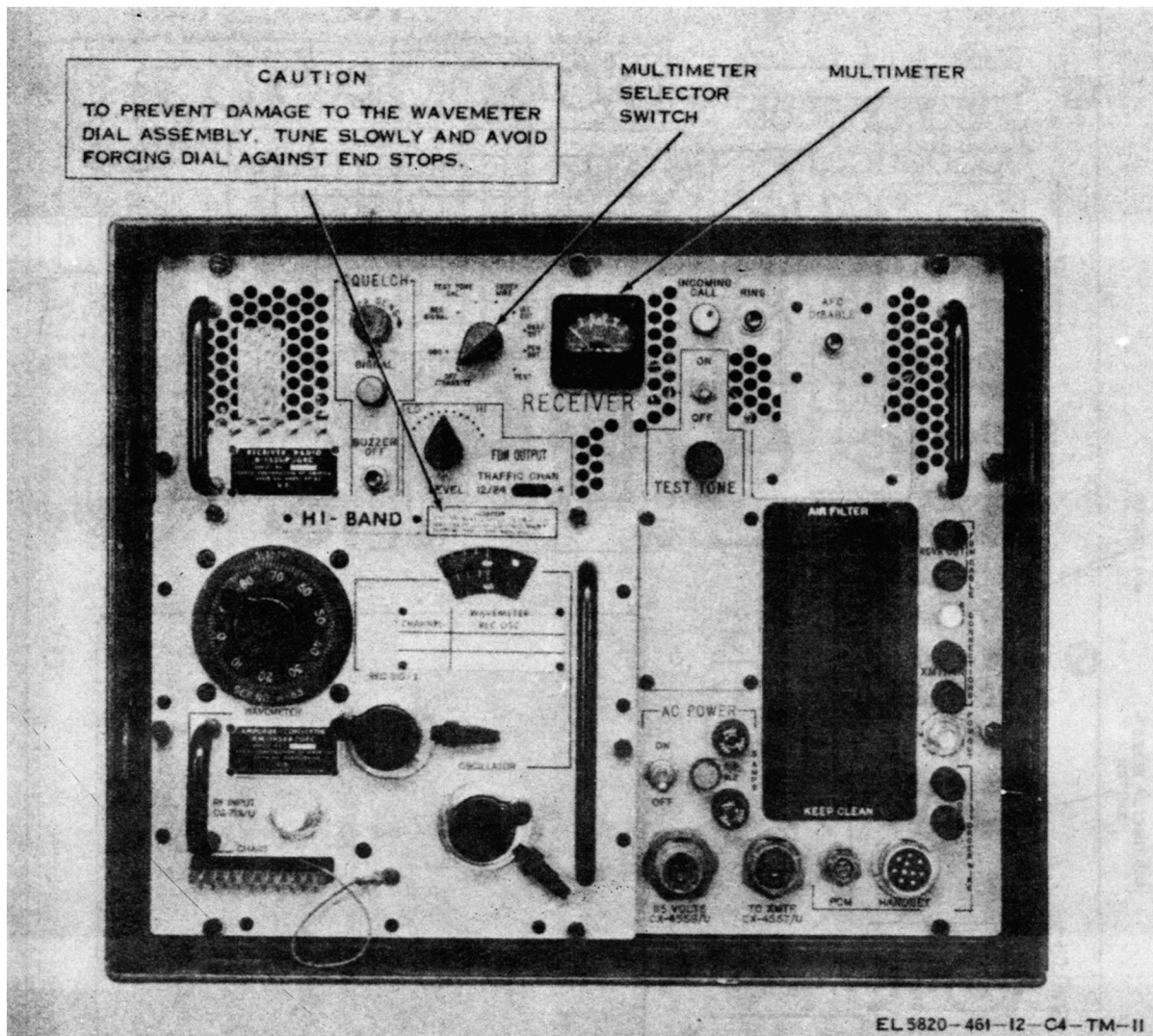

Figure 3-6. Receiver, radio R-1331(*) (P)/GRC, and Amplifier-Converter AM-1956A/GRC from panel view

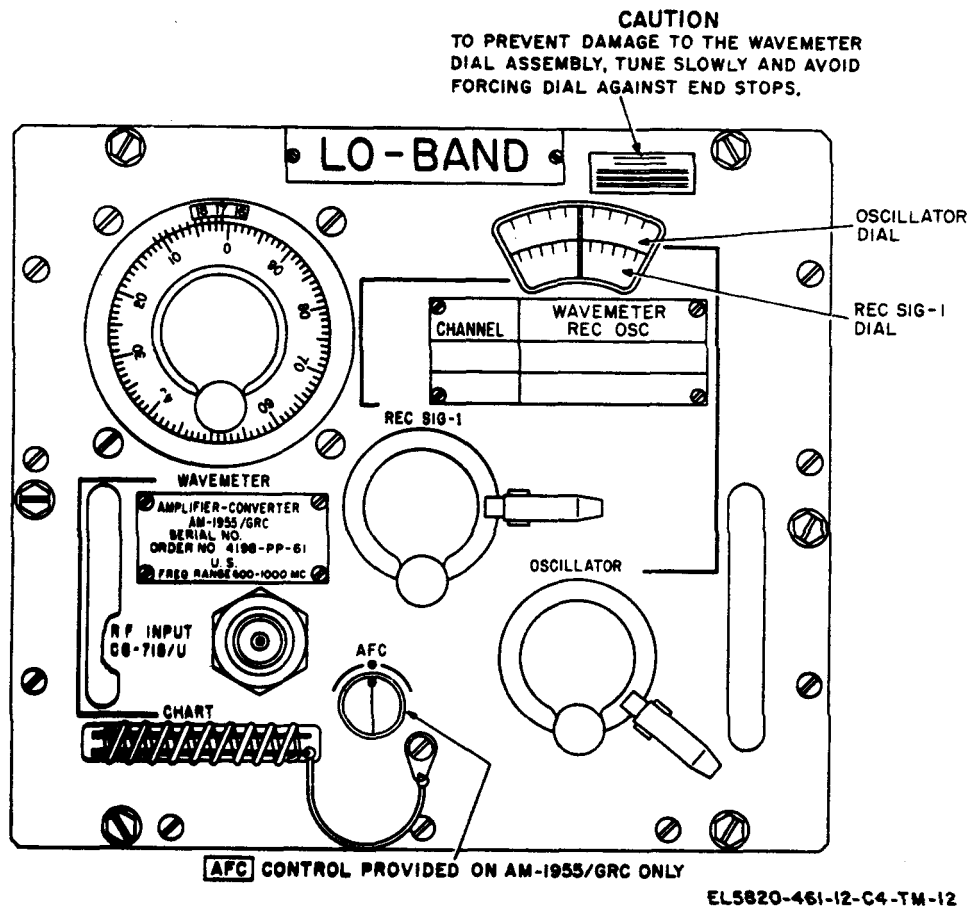

Figure 3-7. Amplifier-Converter AM-1955(*)/GRC,
front panel view.

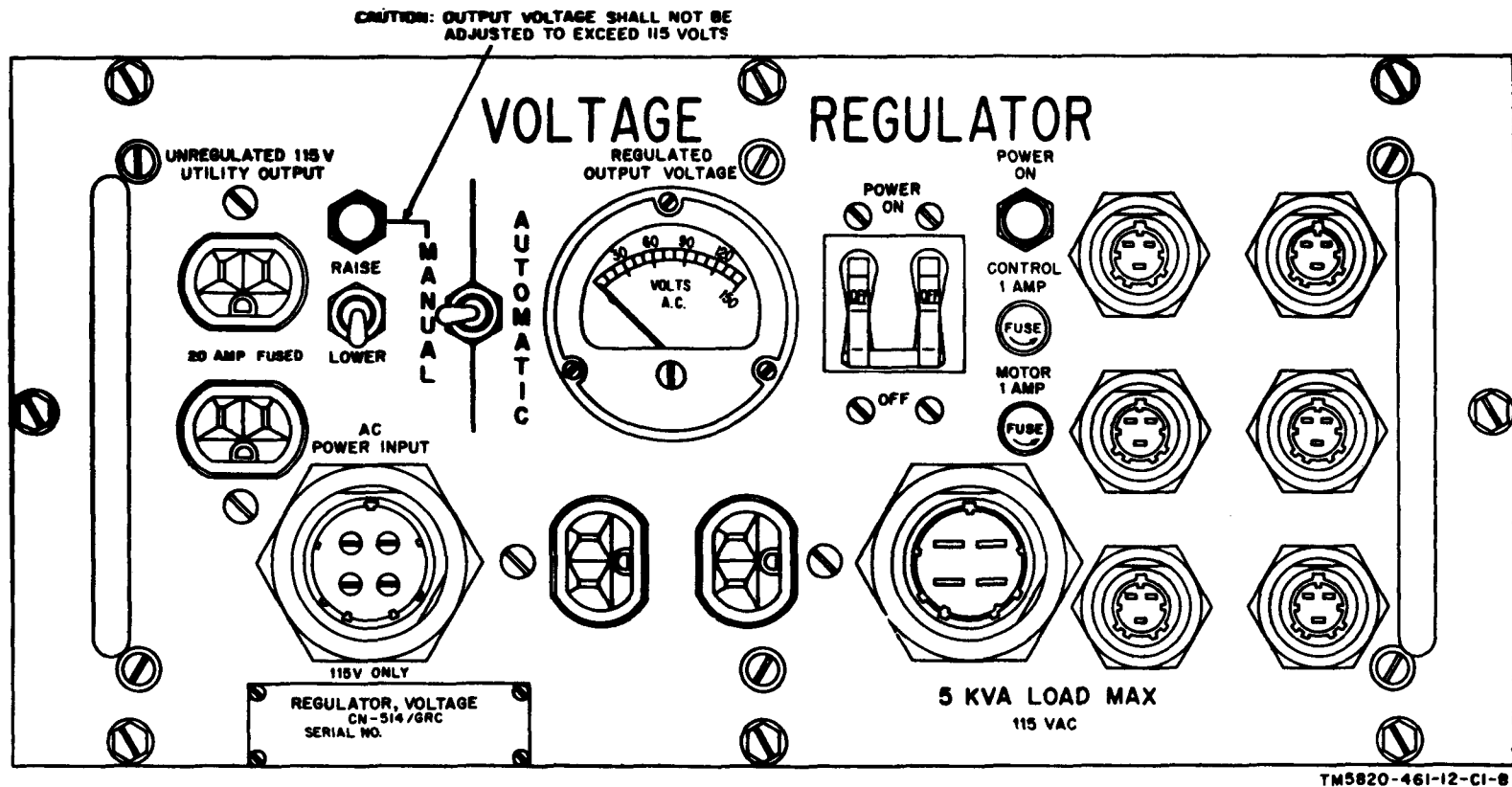

Figure 3-8. Regulator, Voltage CN-514/GRC, front panel view.

Figure 3-8. Regulator, Voltage CN-514/GRC, front panel view.

Section II. TUNING PROCEDURES

CAUTIONS

- 1 To prevent damage to the crystal diode in the receiver mixer assembly, the transmit and receive channel frequencies must be separated by at least 15 channels(15 megacycles). To observe this precaution never turn the REC SIG1 and OSCILLATOR controls in the receiver, or the REC SIG-2 controls of the transmitter, closer than 15 channels to the transmitter MAIN TUNING control setting. Conversely; never turn the transmitter MAIN TUNING control closer than 15 channels to the REC SIG-2 setting in the transmitter, and RCV SIG-1 and OSCILLATOR setting in the receiver. See caution 2 below for the procedure to be used when changing channels in the transmitter and receiver.
2. Before the radio transmitter or radio receiver is tuned, or retuned to another channel, check the channel frequencies that are set up on the transmitter and receiver to determine whether the channel to be set up will require passing through the channel set up on the other radio. For example, if the transmitter (or receiver) is set up on channel 550 and the receiver (or transmitter) is to be retuned to some channel below 550, the transmitter must be turned off first as explained in a below.
 - a. When the transmitter or receiver is to be retuned, set the PP-2054(*)/GRC OPERATE-STANDBY switch to STANDBY set the transmitter AFC TUNE-ODD-EVEN switch to TUNE, and the MAIN TUNING POWER OUT, and COUPLING controls to the new channel; then reset the PP-2054(*)/GRC OPERATE-STANDBY switch to OPERATE. Wait approximately 75 seconds for the LV and HV indicators to light before tuning the transmitter.
 - b. Do not reset PP-2054-(*)./GRC OPERATE-STANDBY switch to operate without ensuring the transmitter and receiver are preset 15 channels apart.
3. Do not turn on the transmitter (by setting the PP-2054(*)/GRC OPERATING-STANDBY switch to OPERATE) unless the DA-189/GRC or the complete antenna system is connected to the transmitter. Failure to observe this precaution may result in damage to the transmitter duplexer assembly which, in turn, may provide incorrect meter readings for PWR OUT and REF PWR.
4. To prevent damage to the WAVEMETER dial assembly, turn the dial slowly and avoid forcing the dial against the end stops.
5. Operate the CN-514/GRC on automatic control (para 3-7b(3)). Do not operate it on manual control unless the automatic function is defective. In which case, the output voltage must be adjusted to 115 volts and monitored to insure it does not exceed 115 volts.

3-4. General

Before the radio set is used in a communication system, it is tuned to the assigned operating channels (paras 3-7 through 3-11). When the equipment has been satisfactorily tuned, the telephone carrier equipment is connected to the radio system, and the radio is adjusted to the type of multiplex equipment used (para 3-13 or 3-14). Finally, the radio sites are operated on a routine basis, using the order wire circuit for communication between the radio sites and between the radio sites and multiplex equipment.

3-5. Installation of Tuning Units

Use the procedures given below to change the AM-1957/GRC and AM-1958(*)/GRC in the transmitter; the AM-1955/GRC and AM-1956/GRC in the R1148(P)/GRC; and the AM-1955A/GRC or AM-1955B/GRC and AM-1956A/GRC or AM-1956B/GRC in the R-1331(*)/GRC.

CAUTION

To prevent serious damage to the radio set, remove the primary power from the equipment while performing the following procedures.

NOTE

In an emergency, the AM-1955A/GRC and AM-1956A/GRC may be used in the R-1148(P)/GRC.

a. Remove the short interconnecting cable, CG-718B/U (fig. 6-3), between the AM-1957/GRC and the AM-1955(*)/GRC; or between the AM-1958(*)/GRC and the AM-1956(*)/GRC. Disconnect the antenna cable from the AM-1957/GRC or the AM-1958(*)/GRC.

b. Loosen the captive screws that hold the unit to the unit frame, and slide the unit out.

c. Slide the appropriate unit into the unit frame and tighten the captive screws. Make sure that all the screws are tight.

CAUTION

Make sure that the target bolt screw on the right side of the AM-1957/GRC or AM-1958(*)/GRC (fig. 1-4) is screwed in fully. Failure to make this bolt tight results in no power being applied to the transmitter equipment.

d. Replace the interconnecting antenna cables.

NOTE

When the AM-1957/GRC or AM-1958(*)/GRC is changed in the transmitter, the current regulator circuits *must be checked and adjusted, if necessary* (para 5-13b).

3-6. Determining Channel Frequency

Operating frequencies are generally assigned in megacycles (mc). To convert megacycles to channel numbers of the AN/GRC-50/(*) (V), and channel numbers to megacycles, use the methods given in a and b below. Refer to paragraph 2-3c for information on frequency assignment restrictions.

a. *Low Band.* To convert a channel number to its corresponding frequency, add 600.5 to the channel number.

Example: Determine the frequency of channel 399:

$$\begin{array}{r} 399 \text{ channel} \\ +600.5 \\ \hline 999.5=999.5 \text{ (mc).} \end{array}$$

To determine the channel number from a given frequency, subtract 600.5 from the frequency.

Example: Determine the channel number corresponding to a frequency of 601.5 (mc).

$$\begin{array}{r} 601.5 \text{ (mc).} \\ -600.5 \\ \hline 1 = \text{channel 1} \end{array}$$

b. *High Band.* To convert a channel number to its corresponding frequency, add 950.5 to the channel number.

Example: Determine the frequency of channel 899:

$$\begin{array}{r} 899 \text{ channel} \\ +950.5 \\ \hline 1,849.5=1,849.5 \text{ (mc).} \end{array}$$

To determine the channel number from a given frequency, subtract 950.5 from the frequency.

Example: Determine the channel number corresponding to a frequency of: 1,350.5 (mc).

$$\begin{array}{r} 1,350.5 \text{ (mc).} \\ -950.5 \\ \hline 400.0 = \text{channel 400.} \end{array}$$

3-7. Preliminary Starting Procedures

a. *Checks.*

- (1) Set all power switches and circuit breakers to OFF.
- (2) Check for proper 3-ampere, time-delay fuse in the HV fuse receptacle of PP-2054(*)/GRC (para 1-14g).
- (3) Check to see that all cables are properly installed. Refer to figure 6 3 or the technical manual applicable to the assembly in which the radio set is installed (para 1-14a).
- (4) When pcm multiplex equipment is used, remove the video cable from PCM IN connector on the transmitter (fig. 6 3) and the pcm order wire cable from PCM connector on the receiver until after the transmitter has been tuned and satisfactory reception has been established throughout the system. When fdm multiplex equipment is used, no cables need be removed.

b. *CN-514/GRC Adjustments.* Always use the CN-514/GRC in automatic operation by setting the MANUAL-AUTOMATIC switch in AUTOMATIC position unless the voltage indication on the REGULATED OUTPUT VOLTAGE meter will not remain at 115 volts. In which case, set the MANUAL-AUTOMATIC switch

to MANUAL and adjust the RAISE-LOWER switch until the meter indicates 115 volts. Under this condition, periodically monitor the meter indication and adjust the output voltage to maintain it at 115 volts. Adjust the CN-514/GRC as follows:

CAUTION

Do not exceed the 115-volt output on the CN-514/GRC (fig. 3-8) except for testing. The small increase in output power of the transmitter is offset by reduced life of the tubes in the equipment.

- (1) Set POWER switch to ON.
- (2) Set MANUAL-AUTOMATIC switch to MANUAL, and observe that the MANUAL indicator lamp lights.
- (3) Set RAISE-LOWER switch to LOWER. Hold the switch until approximately 105 volts is indicated on the REGULATED OUTPUT VOLTAGE meter.
- (4) Set MANUAL-AUTOMATIC switch to AUTOMATIC. Observe that the MANUAL indicator lamp goes out and the voltage is automatically raised to 115 volts on the meter.
- (5) Set MANUAL-AUTOMATIC switch to MANUAL, and observe that the MANUAL indicator lamp lights.
- (6) Set RAISE-LOWER switch to RAISE. Hold the switch until approximately 120 volts is indicated on the meter.
- (7) Set MANUAL-AUTOMATIC switch to AUTOMATIC. Observe that the MANUAL indicator lamp goes out and the voltage is automatically lowered to 115 volts on the meter.

3-8. Receiver Tuning Procedures

NOTE

Radio receiver used in the following procedures applies to R-1148(P)/GRC and R-1331(*)/GRC.

CAUTIONS

1. If the AC power fails and the R-1148(P)/GRC is being used, immediately set the AFC TUNE-ODD-EVEN switch to TUNE. After the power is restored, wait about 2 minutes before setting the AFC TUNE-ODD-EVEN switch to the original setting of ODD or EVEN as applicable.
2. Do not turn on the receiver again immediately after it has been turned off. Wait about 5 minutes before turning it on again. This procedure allows power control circuits to be reestablished.

Step	Unit	Switch or control	Position or action
1	Radio receiver.....	AC POWER..... TEST TONE switch TEST TONE control..... FDM OUTPUT LEVEL SQUELCH INCR SENS..... TRAFFIC CHAN.....	OFF. OFF. Maximum counterclockwise. Midrange. Maximum clockwise. Set to 12/24 for fdm multiplex 12- or 24-channel system. Set to 4 fdm multiplex 4-channel system.
2	R-1148(P)/GRC only ^a	AFC LEVEL AFC TUNE-ODD-EVEN	Midrange. TUNE.
3	AM-1955/GRC or AM- 1956/GRC only.	AFC correction.....	Set to midrange (white dot in up position).
4	AM-1955(*)/GRC or AM- 1956(*)/GRC.	REC SIG-1	Set to desired receive channel as indicated on respective dial.
5	AM-1957/GRC or AM- 1958(*)/GRC (In the transmitter).	REC SIG-2	Set to desired receive channel as Indicated on respective dial.
6	AM-1965(*)/GRC or AM- 1956(*)/GRC.	OSCILLATOR.....	Set to desired receive channel as indicated on respective dial.

Step	Unit	Switch or control	Position or action
7	R-1148(P)/GRC ^a	AFC TUNE.....	Set to desired receive channel as indicated on AFC TUNE CHANNEL indicator. (ODD numbered channels are on top scale; EVEN numbered channels are on bottom scale).
8	CN-514/GRC		Check to see that the CN-514/GRC is properly adjusted (para 3-7b).
9	Radio receiver.....	AC POWER.....	ON. The AC POWER indicator should light and the blower motor should run. The INCOMING CALL indicator may light and the buzzer may sound. Wait a few seconds; the INCOMING CALL indicator should go out and the buzzer should stop sounding. Wait approximately 5 minutes before proceeding to the tuning procedures.
10	AM-1955(*)/GRC or AM-1956(*)/GRC.	<i>Tuning procedure</i> WAVEMETER.....	Set the wavemeter dial to the position indicated in the WAVE-METER chart under REC OSC column which corresponds to the desired channel. Caution: Before tuning the receiver OSCILLATOR control, check the channel settings of the OSCILLATOR control and the transmitter MAIN TUNING control. If the receiver channel to be set up is on the other side of the transmitter channel, turn off the receiver (AC POWER switch to OFF) until the OSCILLATOR control is set to the new channel. See cautions No. 1 and 2 at the beginning of this section.
11	Radio receiver.....	Multimeter selector.....	OSC.
12	AM-1955(*)/GRC or AM-1956(*)/GRC	OSCILLATOR.....	Adjust for peak indication on multimeter. Lock the control
13	R-1148(P)/GRC only ^a	Multimeter. Selector	AFC LEVEL.
		AFC LEVEL	Adjust for peak indication on multimeter.
		AFC TUNE	Adjust for peak indication on multimeter.
		AFC TUNE-ODD-EVEN	Set the switch to ODD when the receiver channel is odd numbered (e.g., 401, 403, 405, etc.) or to EVEN when the receiver channel is even numbered (e.g. 402, 404, 406, etc.).
		AFC correction.....	Rotate control until AFC meter indicates approximately 40 on either side of center scale. The AFC meter needle and the AFC correction control should simultaneously move back to near center position.

Step	Unit	Switch or control	Position or action
14	AM-1955/GRC or AM-1956/GRC in R-1148(P)/GRC only.	WAVEMETER	Adjust for maximum indication on the multimeter. The WAVE-METER dial setting should indicate within two divisions of the setting required according to the REC OSC column for the desired channel. If the dial setting is beyond this requirement, repeat the tuning procedures to this point (steps 10 through 14 above).
15	Radio receiver.....	<i>Tuning receiver to distant terminal</i>	REC SIGNAL. The multimeter. should show 0 (no signal) indication until the signal from the distant station transmitter causes the meter needle to deflect. At this indication, adjust REC SIG-1 control for peak meter indication. Use the order wire to communicate with the distant terminal (para 3-18). Do not use the clarity of the order wire to tune in the receiver. Check with the distant station transmitter to insure that the pcm video cables are not connected at that station (para 3-14c, caution and note). Hold this switch depressed while performing the next adjustment in step 18.
16	AM-1955(*)/GRC or AM-1956(*)/GRC.	Multimeter. selector switch..... REC SIG-1	
17	R-1331(*)/GRC only ^b	AFC DISABLE	Adjust for peak indication on multimeter. Lock the control. Release the AFC DISABLE switch.
18	AM-1955(*)/GRC or AM-1956(*)/GRC	OSCILLATOR	Adjust for peak indication on multimeter. It is not necessary to turn on the transmitter for this adjustment.
19	In the transmitter: AM-1957/GRC or AM-1958(*)/GRC.	REC SIG-2	Elevation-depression adjustments of the AT-903/GRC cannot be made after it has been erected (TM 11-5820-538-12). The procedures in steps 21 through 23 below refer to azimuth adjustment only.
20	Antenna (AT-903/GRC or equivalent).	<i>Note 1</i> The following antenna adjustments assume a two terminal radio link. Repeat these procedures for each radio link. One terminal is referred to as terminal A, the other as terminal B (fig 3-10) <i>Note 2</i> To with the person stationed at the base of the antenna mast (fig 3-9), locate a field telephone at the antenna mast base Connect a pair of telephone field wires between the telephone and REMOTE connectors on the receiver (fig 6-3) Use the order wire to communicate with the person at the telephone (para 3-18a)

Step	Unit	Switch or control	Position or action
21	Radio Receivers, terminals A and B.	Multimeter selector switches	Caution: Unless a telephone signal converter is used with the telephone, do not use the telephone ringer. The 20 cps ringing voltage can damage the radio receiver. REC SIGNAL.
22	Terminal B radio receiver	Observe receiver multimeter indication and advise the person located at the antenna base to rotate the base of the AB-577/GRC (fig. 3-9) back and forth approximately 15° until peak meter indication is obtained. Continue to observe receiver multimeter indication and advise terminal A to rotate his AB-577/GRC to attempt to raise received signal indication.
23	Terminal A radio receiver	Observe receiver multimeter indication and advise the person located at the antenna base to rotate the AB-577/GRC back and forth approximately 15° until peak meter indication is obtained. Check with terminal B radio receiver and arrange a compromise of antenna adjustment to provide highest indication of received signal levels at both terminals.
24	AM-1955/GRC or AM-1956/GRC in R-1148(P)/GRC only.	AFC correction control	If AFC correction control is more than 10° from center position after about 20 minutes of operation, repeat tuning procedures (step 2 and steps 10 through 14 above)
25	Radio receiver	<i>Radio receiver squelch adjustment</i> Multimeter selector switch.....	REC SIGNAL
26	AM-1955(*)/GRC or AM-1956(*)/GRC,	REC SIG-1	Adjust until signal is just audible in H-156/U.
27	Radio receiver.....	SQUELCH INCR SENS.....	Starting at maximum clockwise position, rotate until SQUELCH NO SIGNAL indicator lights and buzzer sounds. Silence buzzer by depressing SQUELCH BUZZER OFF pushbutton.
28	AM-1955(*)/GRC or AM-1956(*)GRC.	REC SIG-1	Readjust to obtain maximum indication on multimeter SQUELCH NO SIGNAL indicator should extinguish and buzzer should sound. Silence buzzer by depressing SQUELCH BUZZER OFF PUSHBUTTON.
29	Radio receiver.....	<i>System lineup procedures</i>	The proceeding tuning procedures apply whether fdm or pcm equipment is used with the radio set. After the transmitter has been tuned (para 3-11) perform system lineup procedures For fdm equip-

Step	Unit	Switch or control	Position or action
			ment, refer to paragraph 3-13; for pcm refer to paragraph 3-14 To retune the radio receiver to another channel, perform the operations given in steps 10 through 28 above. When R-1148(P)/GRC is used, set AFC TUNE ODD-EVEN switch to TUNE before performing the operations.

^a Omit this step If the AM-1955A/GRC or AM-1966A/GRC is being used In the R-1148(P)/GRC

^b If the AM-1955A/GRC or AM-1966A/GRC is being used In the R-1148(P)/GRC, this operation by connecting a jumper between test Jacks J5 and J7 on second IF assembly 3A5 (fig 5-8). Remove the Jumper after the adjustment is made

3-9. Transmitter Tuning Requirements

Some precautions that must be observed during the operation of the transmitter are given in a through i below.

CAUTION

Never turn on the transmitter (by setting the PP-2054()/GRC OPERATE-STANDBY switch to OPERATE) unless the DA-189/GRC or the complete antenna system is connected to the transmitter (fig. 6-3). Failure to observe this caution will result in damage to the duplex assembly which, in turn, will indicate incorrect meter readings for PWR OUT and REF PWR.*

- a. Observe the required frequency (channel) separation between the transmitter and receiver (para 2-3c).
- b. Check to see that the target bolt on the amplifier-oscillator (fig. 1-4) is fully screwed in. If the bolt is not fully screwed in, no power will be applied to the transmitter.
- c. When the amplifier-oscillator is changed in the transmitter, or a tube in the amplifier-oscillator is changed, a check of, and adjustment if necessary, must be performed on current regulator control R14, R15, or R16 (fig. 6-4). Procedures for the check and adjustment are given in paragraph 5-13b.
- d. When the transmitter is operating with pcm multiplex equipment, the cable connection to the PCM IN connector must be removed until all receivers throughout the system have been satisfactorily lined up to the transmitter frequency.
 - (1) When the pcm multiplex frequency band is applied to the transmitter, the REC SIG indication at the distant receiver will usually be lowered, this is normal. If the receiver operator readjusts REC SIG-1 control to obtain a higher indication (which sometimes can be done), he will be tuning to a transmitter carrier signal which is no longer peaked at the point of the original transmitter carrier signal (before pcm modulation). The receiver circuits can still accept this dislocation without distorting the pcm intelligence.
 - (2) If the receiver were tuned to the peak of the dislocated carrier signal, it could result in a loss or distortion of some speech or intelligence on one end of the pcm band. This problem does not exist when fdm multiplex signal band is applied to the transmitter carrier signal.
- e. For cold and damp areas or after an overnight turnoff, the following starting procedures are required:
 - (1) Raise the shelter or room temperature before turning on the equipment.
 - (2) On the receiver, set the AFC selector switch to TUNE and the AC POWER switch to ON.
 - (3) On the transmitter, set the AFC TUNE-ODD-EVEN switch to TUNE and the PP-2054(*)/GRC OPERATE-STANDBY switch to STANDBY.
 - (4) Leave the equipment in this warmup condition until the room and the equipment have warmed up.
- f. Before time-delay relays were installed in the transmitter by the application of MWO

11-5820-461-35/3 (for equipment procedure on orders No. 4198-PP-61, 15104-PP 62, and 64027-PP-63), it was necessary to set the transmitter AFC TUNE-ODD-EVEN switch to TUNE and the PP-2054(*)/GRC OPERATE-STANDBY switch to STANDBY as soon as an ac power interruption occurred. This procedure was required to deactivate the transmitter arc motor correction until the afc and oscillator tube circuits had warmed up after the power restoration. Failure to set the switch to TUNE usually resulted in the transmitter locking in on the wrong transmitting frequency after the power was restored. In transmitters modified by the MWO and in the later-procured transmitters, this requirement is no longer necessary.

g. Observe the following precaution:

- (1) After the transmitter has been tuned, do not increase the CN-514/GRC output voltage beyond 115 volts. The small increase in transmitter power obtained as a result of increasing the CN-514/GRC voltage is countered by greatly reducing the life of the tubes in the amplifier-oscillator.
- (2) Keep the transmitter AFC TUNE-ODD-EVEN switch at ODD or EVEN, as applicable, to prevent frequency drift after the transmitter has been tuned. This requirement is even more important in those systems in which the R-1331(*) (P)/GRC IS used, since the primary afc circuit of this receiver has been removed.

h. On the WAVEMETER CHART are condensed tuning procedures. However, always tune the transmitter first with the DA-189/GRC and after it has been determined that the transmitter is functioning satisfactorily for the assigned channel, connect the transmitter to the antenna system.

3-10. Transmitter Tuning Procedures

a. General.

- (1) Observe the cautions given at the beginning of this section and the instructions given in paragraph 3-9.
- (2) Depress the BUZ OFF pushbutton each time the buzzer sounds. The LOW POWER indicator is a true indication and on crates only when the output power is below the preset level (steps 17 and 18 in b below).
- (3) To check the performance of transmitter, receiver, and associated multiplex equipment at a terminal or repeater station before going on a mission, use the loop-back tuning procedures given in paragraph 3-11.

b. Procedure.

Step	Unit	Switch or control	Position or action
1	DA-1891/GRC	<i>Preliminary operations</i>	Use CG-718B/U and connect DA-189/GRC to TO ANT receptacle on the amplifier-oscillator. ON POWER. ON indicator lights AUTOMATIC. The meter should indicate 115 volts (para 3-7b) STANDBY ON. The FIL indicator lights. The blower motors in the PP-2054(*)/GRC and transmitter should be heard running Allow the PP-2054(*)/GRC to warm up for approximately 15 minutes.
2	CN-514/GRC	POWER	
3	PP-2054(*)/GRC	OPERATE-STANDBY	
		AC POWER	
4	Transmitter	AFC CORRECTION	Midrange Midrange. Midrange TUNE. Set to assigned transmitting channel. Odd-numbered channels are on top scale; even ones on bottom scale. Set to 12/24 for fdm multiplex system
		PCM INPUT LEVELS	
		FDM INPUT LEVELS	
		AFC TUNE-ODD-EVEN	
		AFC TUNE	
		TRAFFIC CHAN	

Step	Unit	Switch or control	Position or action
5	Amplifier-oscillator.....	POWER OUT..... COUPLING..... MAIN TUNING..... REC SIGN.....	Set to 4 for 4-channel fdm multiplex system Unlock all controls. Set to assigned transmitting channel. Set to assigned transmitting channel. Caution: Observe cautions 1 and 2 given at beginning of this section. Set to assigned transmitting channel. This is receiver tuning control. It should be set to assigned receiving channel.
6	PP-2054*/GRC.....	OPERATE-STANDBY.....	OPERATE. LV and HV indicators should light. <i>Note 1. When multimeter indications are off scale, depress METER SHUNT push button and continue control adjustment for peak meter needle deflection</i> <i>Note 2. The MAIN TUNING control must be locked after adjustment</i> Adjustment of OSC, AMP, and MIXER may change setting of MAIN TUNING control
7	Amplifier-oscillator.....	<i>MAIN TUNING operations</i> WAVEMETER.....	Set control to setting listed under MAIN TUNE column of the WAVE METER chart corresponding to the assigned transmitting channel.
8a	AM-1957/GRC only.....	MAIN TUNING.....	Set multimeter switch to MAIN TUNE and adjust control for peak multimeter indication. Lock the control.
8b	AM-1958(*)/GRC only.....	OSC..... MAIN TUNING.....	Set multimeter switch to OSC and adjust control for peak multimeter indication Set multimeter switch to MAIN TUNE and adjust control for peak multimeter indication.
8c	AM-1958(*)/GRC only.....	Repeat tuning procedures in step 8b.
9	Amplifier-oscillator.....	WAVEMETER.....	Lock the MAIN TUNING control. Set control to setting: listed In OUT FREQ column of WAVEMETER chart corresponding to assigned transmitting channel.
10	Amplifier-oscillator.....	MIXER.....	Set multimeter switch to MIXER and adjust control for peak multimeter indications.
11	Amplifier-oscillator.....	AMP.....	Set multimeter switch to AMP and adjust control for peak multimeter and DA-189/GRC meter indications
12	Transmitter.....	AFC CORRECTION.....	Adjust control through its range to obtain peak multimeter indication; the control should be within 40 degrees of center position <i>Note</i> If either of these conditions is not met, reset AFC CORRECTION to midposition and repeat tuning in steps through 11.

The procedures from this point prepare the transmitter for maximum output. The procedures in steps 12 through 19 check the performance of the transmitter with Dummy Load DA-189/GRC. When the transmitter performance is satisfactory, the antenna system is connected and the transmitter is tuned for maximum output (steps 20 through 25).

Step	Unit	Switch or control	Position or action
13	Amplifier-oscillator.....	<i>Output power operation</i> WAVEMETER.....	<p>Check that action of step 9 has been performed.</p> <p>Set multimeter selector switch to PWR OUT.</p> <p>Adjust POWER OUT control for peak DA-189/GRC and multimeter indications.</p> <p>Adjust controls for peak DA-189/GRC meter and multimeter indications</p> <p>Readjust the three controls until no further increase in meter indications can be obtained.</p> <p>While carefully adjusting AMP control, rotate COUPLING control for peak meter indications.</p> <p>Lock the controls.</p> <p>With AM-1957/GRC, the meter should indicate more than 12 watts for channels 1 through 99 and more than 15 watts for channels 100 through 399.</p> <p>With AM-1958(*)/GRC, the meter should indicate more than 8 watts REF PWR. The multimeter indication should be near zero.</p> <p>PWR OUT. The multimeter indication should be no less than 20; exception; for channels 1 through 20 using AM-1957/GRC), the indication should be no less than 16.</p> <p>MAIN TUNE. The multimeter indication should be no less than 10 AMP. The multimeter indication should be no less than 10.</p> <p>Set multimeter switch to PWR OUT</p> <p>Adjust control to lower DA-189/GRC Indication to 5 watts when AM-1958(*)/GRC 19 being used or to 11 watts when AM-1957/GRC is being used.</p> <p>Adjust control until LOW POWER indicator lights. The buzzer should sound. Silence buzzer with BUZ OFF pushbutton</p> <p>Adjust control for peak DA-189/GRC meter and multimeter indications</p> <p>The buzzer should sound, silence it with BUZ OFF pushbutton.</p> <p>If LOW POWER Indicator is not extinguished at this point, higher maintenance services are required to correct the fault.</p>
14	Amplifier-oscillator.....	POWER OUT.....	
		AMP and COUPLING.....	
15	DA-189/GRC.....	POWER OUT and COUPLING.....	
16	Transmitter.....	Multimeter selector switch.....	
17	Amplifier-oscillator.....	POWER OUT.....	
18	Transmitter.....	ALARM ADJ.....	
19	Amplifier-oscillator.....	POWER OUT.....	

When the transmitter is satisfactory to this point, connect the antenna to the transmitter (step 20) and tune the power circuits again (steps 21 through 25)

Step	Unit	Switch or control	Position or action
20	Transmitter	<p>Disconnect the pcm equipment cable from PCM IN receptacle on the transmitter (fig. 6-3) The fdm equipment cables need not be removed.</p> <p>Check that the transmitter AFC TUNE-ODD-EVEN switch is set to TUNE</p> <p><i>The following three operations must be performed within 6 seconds (After 6 seconds, the time-delay circuits remove power from the oscillator and amplifier circuits of the amplifier-oscillator)</i></p> <ol style="list-style-type: none"> 1. Operate PP-2054(*)/GRC OPERATE-STANDBY switch to STANDBY. 2. Remove DA-189/GRC connection and connect antenna cable to transmitter. 3. Reset PP-2054(*)/GRC OPERATE-STANDBY switch to OPERATE. <p>If the above three operations take more than 6 seconds, the tuning procedures in steps 7 and 8 must be performed before proceeding to step 21.</p> <p>Make sure all antenna cable connections are tight and that the antenna is properly oriented toward the next receiver in the radio system.</p>
21	Amplifier-oscillator	MIXER	<p>Set multimeter switch to MIXER and adjust control for peak meter indication</p>
22	Amplifier-oscillator	<p>POWER OUT.....</p> <p>AMP.....</p> <p>AMP and COUPLING</p> <p>POWER OUT.....</p>	<p>Check that the WAVEMETER control is still set for OUT FREQ setting of channel being used.</p> <p>Set multimeter switch to PWR OUT. Adjust control for peak multimeter indication</p> <p>Adjust control for peak multimeter indication</p> <p>Adjust AMP control while rotating COUPLING control for peak multimeter indication.</p> <p>Set multimeter selector switch to REF PWR. Carefully readjust control to obtain maximum dip indication on multimeter. When the AM-1957/GRC is used, if two dips occur, adjust the control to the peak indication <i>between</i> dips. When the AM-1958(*)/GRC is used, do not adjust for a dip.</p>

Step	Unit	Switch or control	Position or action
23	Transmitter	AMP and COUPLING	Set the multimeter switch to PWR OUT. Carefully readjust the AMP control while rotating COUPLING control for peak multimeter indication Lock these controls Set the switch to REF PWR and PWR OUT; note the meter indications. PWR OUT indication should be not less than four times the REF PWR indication. With the AM-1957/GRC, the REF PWR indication may be higher than the PWR OUT indication when the transmitter is being tuned on the upper end of the band. When the correct indication is not obtained, check the antenna system, particularly cable connections Note The REF PWR indication should only be used as a reference so that if it should increase, trouble may have occurred in the antenna system. The more nearly the antenna system is matched to the frequency being used, the lower will be the REF PWR reading, and the farther will be the separation between REF PWR and PWR OUT readings
24	Transmitter	Multimeter selector switch AFC LEVEL..... AFC TUNE AFC LEVEL and AFC TUNE..... AFC TUNE-ODD-EVEN..... AFC CORRECTION	AFC LEV. Adjust for peak multimeter indication. Rotate a number of turns to locate the peak position at which the AFC meter indicates near center scale Adjust for peak multimeter indication Readjust for peak multimeter indication and center AFC meter indication. Set to ODD for odd-numbered channels (501, 503, 505, etc.), set to EVEN for even-numbered channels (502, 504, 506, etc.) Check afc circuit for proper lock-on by rotating the control slightly in either direction until AFC meter indicates 40 (right or left). The meter indication should slowly move back to midposition. The control should also move back to midposition Check the transmitter frequency by moving the WAVE METER control (in the area in which it is preset) for peak multimeter indication. If the WAVEMETER dial is not within two divisions of the required setting for the channel, repeat the tuning procedures using steps 7, 8, and 21 through 24 above, after setting AFC TUNE-ODD-EVEN so switch to TUNE

Step	Unit	Switch or control	Position or action
25	Transmitter.....	Reconnect the cable from the pcm multiplex equipment to PCM IN receptacle (fig 6-3) <i>after</i> all receivers in the system have been lined up.
26	Transmitter.....	Multimeter selector switch.....	Set the switch to each position between OSC and AFC LEV and record the meter indication for each position. When the system is lined up, record the meter indications for each position between IKC IN to PCM IN. The indications will be used as reference during periodic checks of the system (para 3-19 <i>b</i>).
		<i>System lineup operations</i>	
27	Transmitter.....	For remaining system lineup procedures with fdm equipment, refer to paragraph 3-13. For remaining system lineup procedures with pcm equipment, refer to paragraph 3-14
		<i>Returning operations</i>	
28	Transmitter.....	To change operation to another channel, proceed as follows: Notify multiplex terminals that system operation will be interrupted until the radio system is satisfactorily lined up. Before changing channels, review the requirements specified in cautions 1 and 2 at the beginning of this section. When pcm multiplex equipment is used, disconnect the pcm cable from PCM IN receptacle (fig. 6-3).
29	Transmitter.....	AFC TUNE ODD-EVEN	TUNE.
		AFC CORRECTION	Midrange.
30	Amplifier-oscillator.....	AFC TUNE	Set to assigned transmitting channel.
		POWER OUT, COUPLING, and MAIN TUNING.	Set to assigned transmitting channel
31	Amplifier-oscillator.....	Perform tuning operations in steps 7 and 8.
		Perform operations in steps 21 through 26.
32	Transmitter.....	Check the operation of the multiplex system (para 3-13 or 3-14).

3-11. Single Stack Look-Back Operational Tests

a. General. The loop-back operational tests given in *b* below allow the attendant to make a complete operational check of the terminal prior to undertaking a mission. The procedure makes use of the "image" frequency response of the receiver which is always 120 channels above the transmitter frequency. The test channels used in the following procedure are channel 500 for the transmitter and channel 620 for the receiver. Whenever possible, tune the transmitter to the assigned channel frequency and the receiver to a test channel 120 channels above the transmitter

channel frequency (para 2-3c(3)). This procedure would then require a minimum retuning after the terminal checkout has been completed. Refer to caution at the beginning of this section before tuning the transmitter and receiver to the assigned operating frequencies.

b. *Tuning and Testing Procedures.*

NOTE

This image loopback check cannot be made when PCM is in secure.

Step	Unit	Switch or control	Position or action
		<i>Preliminary operations</i>	
1	DA-1891GRC	Use CG-718B/U and connect DA-189/GRC to the TO ANT receptacle on the amplifier-oscillator.
2	CN-514/GRC	POWER..... MANUAL-AUTOMATIC	ON. AUTOMATIC. The REGULATED OUTPUT VOLTAGE meter should indicate 115 volts (para 3-7b).
3	PP-2054(*)/GRC.....	OPERATE-STANDBY	STANDBY.
4	Receiver	AC POWER..... AC POWER..... OSC	ON. OFF. Set to test channel 620 (or 120 channels above assigned transmitter channel).
		REC SIGN	Set to test channel 620 (or 120 channels above assigned transmitter channel).
		TEST TONE switch.....	OFF.
		AFC TUNE-ODD-EVEN.....	TUNE. (This applies only to R-1148(P)/GRC.)
		WAVEMETER.....	Set control to setting listed under REC OSC column of WAVEMETER chart for test channel 620 (or 120 channels above assigned transmitter channel).
6	Transmitter.....	AFC CORRECTION..... PCM INPUT LEVELS..... FDM INPUT LEVELS..... AFC TUNE-ODD-EVEN..... AFC TUNE.....	Midrange. Midrange. Midrange. TUNE. Set to test channel 500 (or assigned transmitting channel), as indicated on AFC TUNE indicator.
		TRAFFIC CHAN.....	Set to 12/24 for FDM or PCM multiplex system; set to 4 for 4-channel FDM multiplex system.
6	Amplifier-oscillator..... POWER OUT	Unlock all controls Set to test channel 500 (or assigned transmitting channel).
		MAIN TUNING	Set to test channel 500 (or assigned transmitting channel)
		COUPLING.....	Set to test channel 500 (or assigned transmitting channel)
		REC SIG-2.....	Set to test channel 620 (or 120 channels above assigned transmitter channel).
7	Receiver	AC POWER.....	ON.
8	PP-2054(*)/GRC.....	OPERATE-STANDBY	OPERATE.
9	Amplifier-oscillator.....	WAVEMETER.....	Set control to setting listed under MAIN TUNE column of WAVE-METER chart for test channel 500 (or assigned transmitting channel).

Step	Unit	Switch or control	Position or action
<i>Tuning procedures</i>			
10	Transmitter and amplifier oscillator.	Perform transmitter tuning procedures given in paragraph 3-10 <i>b</i> steps 7 through 19, 24, and 25.
11	Receiver and amplifier converter	<p>Perform receiver tuning procedures given in paragraph 3-8, steps 10 through 19 and 25 through 28.</p> <p>With the loop-back procedures, the REC SIG indication may be too high to be able to determine the peak settings for REC SIG-1 and REC SIG-2. If off-scale indications are obtained, leave these controls on the channel number previously preset in steps 4 and 6 above. These controls will be properly adjusted during system lineup with the distant radio terminal.</p>
<i>Local tests</i>			
12	Receiver	Multimeter selector switch TEST TONE switch..... TEST TONE control	TEST TONE CAL. ON. Adjust for center scale (green area) of multimeter
13	Transmitter	Multimeter selector switch	1 KC MOD. The multimeter should indicate in green area. <i>Note.</i> If the FDM CABLE REC OUT terminals are not connected to FMD multiplex

Step	Unit	Switch or control	Position or action
14	Receiver.....	Multimeter selector switch.....	equipment, the multimeter indication will be to the right of midscale 1 KC OUT and ORDER WIRE. In both positions, multimeter should indicate in green area
15	Handset.....		
16	Receiver.....	TEST TONE switch	Listen on the handset, the 1-kc test tone should be heard.
17	Receiver.....	TEST TONE control..... RING pushbutton	OFF. Counterclockwise Depress the pushbutton. The INCOMING CALL indicator should light and buzzer should sound
18	Handset.....		The 1,600 cps ringing tone should be heard in the handset. Speak into the microphone; sidetone should be heard.
19	PCM or FDM multiplex equipment.	Tests with multiplex equipment a. Turn on and tune the transmitting and receiving equipment.
20	PCM or FDM multiplex equipment.	b. Connect the cables from the transmitting and receiving multiplex equipment to the radio (para 2-8 and fig. 6 3). a. Refer to paragraph 3-13; for fdm equipment or to paragraph 8-14 for pcm equipment and perform the indicated transmission and receiving operations. The required indications should be obtained on the radio equipment and the multiplex equipment. b. Check some of the local channels of the multiplex equipment to determine that satisfactory communication occurs from the transmitting channel back to the associated receiving channel. c. When the equipment performs satisfactorily, proceed to the retuning procedures in c below.

c. Retuning Transmitter and Receiver. After the radio and multiplex equipment have been successfully tested using the procedures in b above, retune the transmitter and/or receiver as given in (1), (2), and (3) below. In retuning the transmitter and receiver, observe the precautions given in caution 2 above at the beginning of this section

- (1) If the transmitter has been tuned to the assigned channel, the DA-189/GRC may be removed and the antenna system connected in less than 6 seconds without retuning the transmitter (step 20, para 3-10b)
- (2) If the transmitter must be retuned to the assigned channel, leave the DA-189/GRC connected and retune the transmitter using the procedures given in steps 7 through 27 of paragraph 3-10b)

- (3) If the receiver must be retuned to the assigned receiving channel, retune the receiver using the procedures given in steps 10 through 29 of paragraph 3-8.

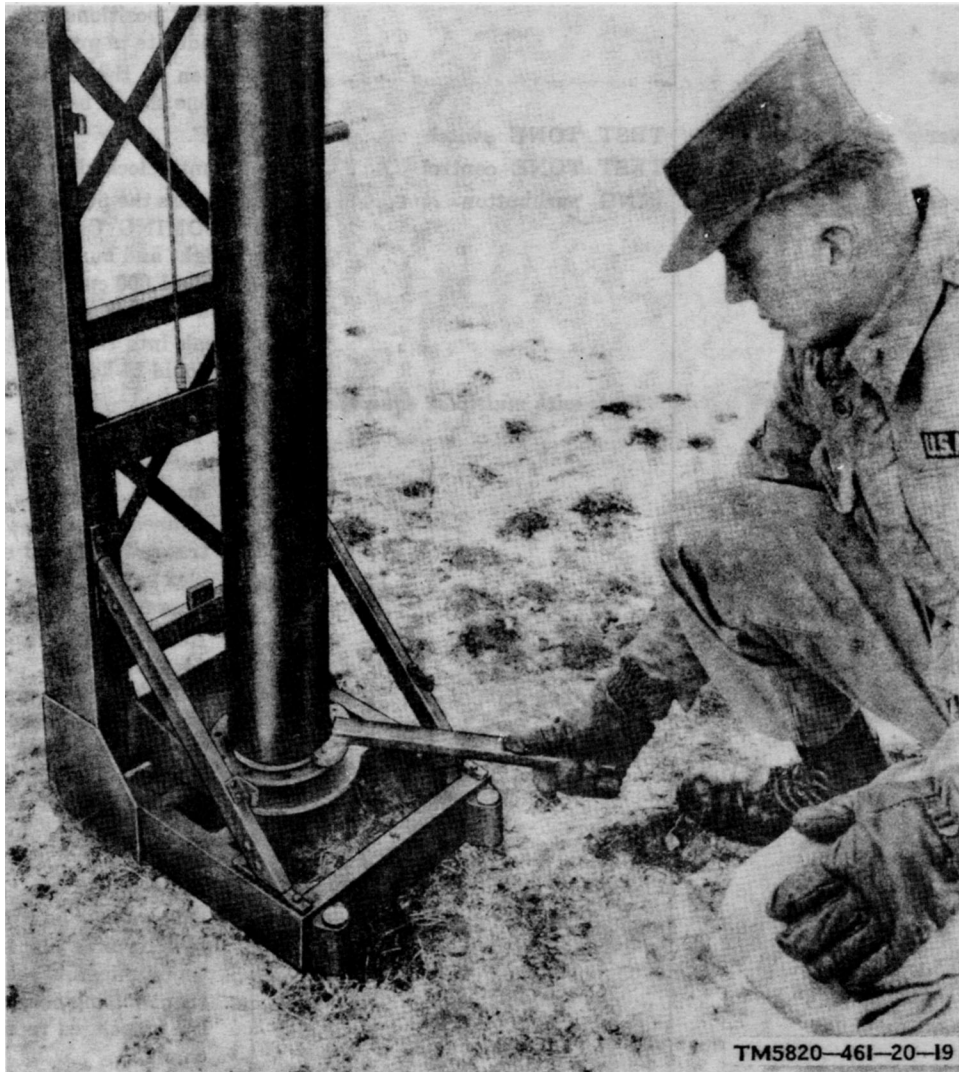

Figure 3-9. Rotating base of Mast AB-577/GRC to change azimuth of antenna on top of mast

Section III. SYSTEM LINEUP PROCEDURES

3-12. General

System lineup consist of checking the system signal levels from station to station in the system. The lineup is required to insure the system provides the optimum communication from terminal to terminal The lineup procedures provide means for setting and checking the receiving levels at all stations in the system. The procedures described use front panel controls only, and the levels are indicated on the front panel meters.

NOTE

When the system lineup is completed, record the meter readings for positions

of the multimeter selector switches and the positions of the other controls. These will be used for routine operations (para 3-19).

a. *Control of Lineup.* All system procedures should be supervised by a designated control station in the system. During lineup procedures, intermediate stations will report completion of lineup procedures to the control station. The control station will then order the next station to begin the procedures.

b. *General Lineup Procedures.* One terminal in the system is designated as the control station; this station will be designated terminal A, and the other terminal as terminal B (fig. 3-10). The lineup procedures will be performed between terminal A and the next station in the line. When the procedures are completed between these two stations, the operator at terminal A will inform the operator at the next station to begin lineup procedures with the station next to it in the A-to-B direction. The lineup procedures are continued until all stations in A-to-B direction of the system have performed system lineup procedures. Terminal B then assumes temporary control of the system, and the lineup procedures are performed in the B-to-A direction. The system is ready for normal operation after completion of the following: lineup procedures in B-to-A direction.

3-13. Fdm System Lineup

The following procedures are used after the transmitting and receiving equipment (radio and fdm) are prepared for system lineup:

- a. Connect the spiral-four cable from the fdm equipment to the receiver (fig. 6-3). The fdm equipment must have been lined up for transmission and reception.
- b. Tune the transmitter (para 3-10) and receiver (para 3 8).
- c. Set the TRAFFIC CHAN switch to 12124 for 135-ohm impedance fdm equipment (such as Terminal, Telephone AN/TCC-7 or AN/TCC-50); set the TRAFFIC CHAN switch to 4 for 600-ohm impedance fdm equipment (such as Terminal, Telephone AN/TCC- 3).
- d. Use the order wire circuit for calling and communication between the radio terminals and the fdm terminals (para 3-18).
- e. Prepare the equipment for 1-kc and 68-kc adjustments as follows:
 - (1) Request the fdm multiplex terminal to transmit 1 kc- test signal adjusted to 0-dbm level.
 - (2) At the radio transmitter, perform the
 - (a) Set the multimeter selector switch

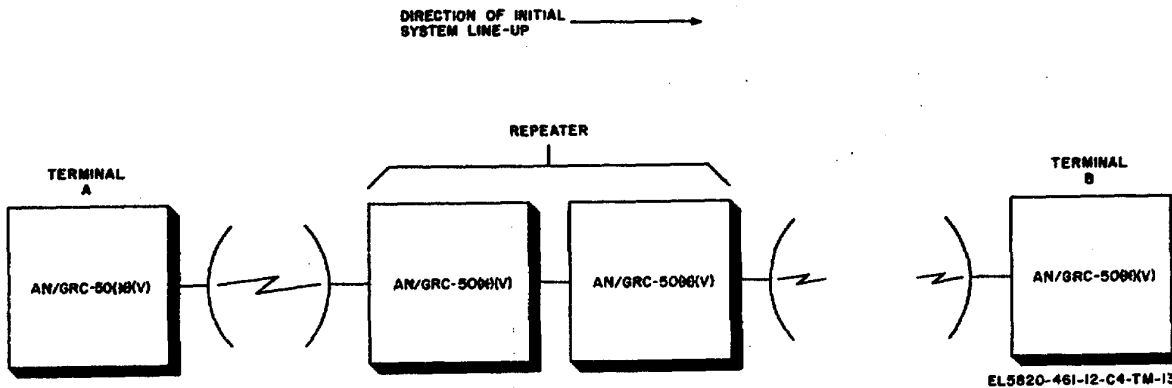

Figure 3-10. System lineup.

TM 11-5820-461-12

to 1 KC IN and 68 KC IN. The transmitter multimeter should indicate within the green area for both positions of the switch. If not, adjust the FDM INPUT LEVELS control until both meter indications are within the green area.

(b) To check the passage of the 1-kc and 68-kc signals through the transmitter, set the transmitter multimeter selector switch to 1 KC MOD and 68 KC MOD. The multimeter should indicate within the green area for both positions of the switch.

(c) If the test signal is not required by the distant receiver terminal ((3) below)? request the fdm terminal to stop sending the test signal

(3) At the radio receiver, perform the following adjustments after the transmitter adjustments ((2) above) have been successfully performed.

(a) Request the preceding transmitter terminal to send 1-kc test signal. Use either the 1-kc, 0-dbm test signal from the fdm terminal; or use the 1-kc test signal from the transmitter (adjusted to 0 dbm (para 3-15a).

(b) Set the receiver multimeter selector switch to 1 KC OUT and 68 KC OUT. The receiver multimeter should indicate within the green area. If the meter does not indicate within the green area, adjust the FDM OUT PUT LEVELS control until the receiver multimeter indicates in the green area for both positions of the meter switch.

(c) Notify the fdm receiving terminal to perform required receive signal adjustments.

(d) At the conclusion of the receiver adjustments, notify the transmitter terminal to stop sending the 1-kc test signal.

(4) Fdm operation should proceed without further radio adjustments, except normal system monitoring (para 3-19).

3-14. Pcm System Lineup

The following procedures are used after the transmitter and receiver (radio and pcm) are prepared for system lineup

a. Tune the transmitter (para 3-10) and the receiver (para 3-8) without the pcm video and order wire cables connected to the radio sets (fig. 6-3).

b. When satisfactory radio reception is obtained, connect the pcm video and order wire cables to the radio sets (fig. 6-3).

c. As soon as the pcm video cable is connected to the transmitter, the REC SIGNAL indication at the radio receiver usually is lowered and will become lower as more channels of the pcm equipment are in operation. For satisfactory pcm operation, the REC SIGNAL indication should be about 20.

CAUTION

When the pcm video cable is connected at distant transmitter, do not readjust the REC SIG-1 and REC SIG-2 controls at the receiving station to attempt to raise the REC SIGNAL level indication

NOTE

When pcm signals are applied to the transmitter, the peak of the radio carrier signal is moved slightly to one side of the assigned carrier frequency; this is normal. Readjustment of the REC SIG-1 and REC SIG-2 controls at the receiver will increase the REC SIGNAL indication. However, to do so usually will result in loss of intelligence of some pcm channels at one end of the pcm band. This problem does not exist with fdm signals, thus the fdm cables can be connected to the radio before radio system lineup.

d. Adjust the order wire circuit in both directions as follows:

(1) At the transmitting radio terminal, turn on and adjust the output of the 1-kc test signal (para 3-15a). To check the level of the test signal, set the transmitter multimeter selector switch to 1 KC MOD. The multimeter should indicate in the green area. Do not attempt to increase the indication obtained

(2) At the receiving terminal, request the pcm terminal operator to adjust the level of the 1-kc test signal to the proper indication on the pcm indicator.

(3) From the pcm terminal, the test signal (and order wire channel) is applied through the radio receiver to the metering circuit (and the handset). To check the level of the 1-kc test signal, set the receiver multimeter switch to ORDER WIRE. The multimeter shows some indication; record the indication obtained for future use. Do not attempt to increase the indication obtained.

(4) At the conclusion of the 1-kc test signal test, request the transmitting terminal to stop sending the test signal. ((1) above).

e. After the order wire circuits have been adjusted (*d* above), adjust the video circuits in both directions as follows:

(1) At the radio receiving terminal, set the receiver multimeter selector switch to PCM OUT.

(2) At the radio transmitting terminal, check to see that the pcm transmitting terminal is properly adjusted for transmission. Then, adjust the PCM INPUT LEVELS control at the radio *transmitter* until the radio *receiving* terminal states that the receiver multimeter indicates in the green area.

(3) At the radio transmitting terminal, set the transmitter multimeter selector switch to PCM IN and record the meter indication for future reference.

(4) At the pcm receiving terminal, adjust the received pcm signal level for proper indications on metering circuits.

(5) At the radio receiving terminal, set the receiver multimeter to PCM OUT and record the meter indication for future reference.

3-15. System Checks and Adjustments

The following procedures are used to check and adjust, if necessary, the passage of signals through the radio set. The procedures are performed on a routine basis after fdm or pcm multiplex equipment is connected to the radio.

a. *Test Tone Calibration.* The following procedure provides adjustment of the 1-kc test signal used for checking the performance of the order wire circuit in the system. Perform the following operations at the receiver:

(1) Set the multimeter selector switch to TEST TONE CAL.

(2) Set the TEST TONE switch to ON.

(3) Adjust the TEST TONE control for an indication of 25 (approx 0 dbm) on the receiver multimeter.

(4) Set the TEST TONE switch to OFF and TEST TONE control fully ccw if test tone is no longer required.

b. *Fdm Signal Checks in Transmitter.* These procedures check the passage of the 1-kc and 68-kc signals through the transmitter. The fdm cable is connected to the radio (fig. 6-3) and the fdm equipment is adjusted for proper transmission.

(1) Request the associated fdm multiplex terminal to send a 1-kc test signal adjusted to 0 dbm.

(2) Set the transmitter multimeter selector switch to 1 KC IN and 68 KC IN. The multimeter should indicate in the green area.

(3) If necessary, adjust the FDM INPUT LEVELS control until the meter indicates in the green area for both positions of the switch.

(4) Set the transmitter multimeter selector switch to 1 KC MOD and 68 KC MOD. The multimeter should indicate in the green area. There is no adjustment provided.

b. *Pcm Signal Checks in Transmitter.* These procedures check the passage of the 1-kc and pcm signals through the transmitter. An pcm cables are connected to the radio set and the pcm terminal equipment is properly adjusted for transmission.

(1) On the receiver, set the TEST TONE switch to ON (adjusted for 0-dbm output (*a* above)).

(2) Set the transmitter multimeter selector switch to 1 KC MOD. The multimeter should indicate within the green area.

(3) Set the transmitter multimeter selector switch to PCM IN. The multimeter usually indicates within the green area. The actual indication obtained depends on the setting of the PCM INPUT LEVELS control when it was adjusted during pcm system lineup (para 3-14e).

d. *Fdm Signal Checks in Receiver.* The following procedures check the passage of 1-kc and 68-kc signals through the receiver.

(1) Request the distant transmitter station to send a 1-kc test signal adjusted to 0

TM 11-5820-461-12

dbm. Send it from the radio transmitter (a above) or from the fdm transmitter terminal.

(2) Set the receiver multimeter selector switch to 1 KC OUT and 68 KC OUT. The multimeter should indicate within the green area for both switch positions.

(3) If necessary, adjust the FDM OUTPUT LEVELS control until the meter indicates in the green area for both switch positions.

(4) With the 1-kc test signal still being sent from the distant transmitter station, set the receiver multimeter selector switch to ORDER WIRE. The meter should indicate within the green area. No adjustment is provided.

e. *Pcm Signal Checks at Receiver.* The following procedures check the passage of 1-kc and pcm signals through the receiver:

(1) Request the distant transmitter station to send a 1-kc test signal adjusted to 0 dbm. Send it from the radio transmitter (a above).

(2) Set the receiver multimeter selector switch to ORDER WIRE. The multimeter usually indicates in the green area. The actual indication obtained depends on the setting of the order wire control in the pcm receiver terminal during pcm system lineup (para 3-14d(3)).

(3) Set the receiver multimeter selector switch to PCM OUT. The meter usually indicates in the green area. The actual indication obtained depends on the setting of the PCM INPUT LEVELS control of the *distant* radio transmitter during pcm system lineup (para 3-14e(2)).

3-16. Multiplex Terminal Adjustments

When the radio system has been satisfactorily lined up, using procedures in paragraphs 3-13 or 3-14, and 3-15, the multiplex terminals in the communication system are advised that the radio system is ready for traffic. The multiplex terminals proceed to perform their system lineup. Routine radio operation is discussed in paragraphs 3-17 through 3-20.

Section IV. ROUTINE OPERATING PROCEDURES

3-17. General

a. After the system lineup of the radio and multiplex equipment, the radio operator will periodically monitor the quality of the circuits and check the output power of the transmitter and the level of the signal received on the receiver. Communication among the radio operators and multiplex attendants is accomplished on the order wire circuits.

b. Refer to paragraph 3-19 for routine tests and adjustments used to observe operation of the radio and multiplex equipment circuits.

3-18. Order-Wire Operation

a. *Originating Order Wire Communications.* Use the procedures given below to originate an order wire communication.

(1) Lift Handset H-156/U from its bracket.

(2) Press the RING push-button on the R-1148(P)/GRC or R-1131(*) (P)/GRC front panel to inform the other station (or field telephone) that order wire communication is desired.

(3) Wait for the station called to answer.

(4) Press the Handset H-156/U PRESS-TO-TALK switch and speak into the handset.

NOTE

To originate an order-wire communication from a remote location, follow the operational instructions supplied with the field telephone being used.

(5) For remote operation on the order wire circuit, connect field wire from the REMOTE terminals of the receiver (fig. 6-3) to the remote telephone. To enable 1,600 cps ringing signals from the radio and 20 cps ringing signals from the telephone to function in the order wire circuit, connect a telephone signal converter to the telephone. If the converter is not used, do not ring on the telephone; the 20 cps is not detected in the radio system and the receiver may be damaged by the ringing voltage (6-90 volts ac).

b. *Receiving Order Wire Communications.* If the INCOMING CALL buzzer sounds and the INCOMING CALL lamp lights at the equipment location, an order wire communication ;B being originated at a distant station (or a field telephone). Proceed as follows:

- (1) Lift Handset H-156/U from its mounting brackets.
- (2) Depress the Handset H-156/U PRESS-TO-TALK switch and identify your station.
- (3) Wait for the order wire message.

c. *Pcm or Fdm Operation.* Once the type of operation (pcm or fdm) is determined and the radio set is correctly tuned (paras 3-13 through 3-16), no additional adjustments are required for transmission or reception of multiplexed signals. Use the order wire la and b above) to notify the distant terminal that the equipment is ready for use.

3-19. Monitoring Equipment

a. *General.* The following checklist provides a list of items with nominal or required indications observed by the radio set operator. Each item should be monitored periodically.

b. *Checklist.*

Component	Item	Indication
CN-514/GRC PP-2054(*)/GRC	OUTPUT VOLTAGE	115 volts.
	FIL indicator	Lighted.
	LV indicator	Lighted.
	HV indicator	Lighted.
	Blower	Operating,
	Blower motor	Operating.
Transmitter with AM-1957/GRC or AM-1958(*)/GRC	WAVEMETER	Set within two divisions of re- quired setting according to WAVEMETER CHART.
	MAIN TUNING control	Locked.
	COUPLING control	Locked.
	REC SIG-2 control	Locked.
	POWER OUT control	Locked.
	LOW POWER lamp	Not lighted.
	AFC TUNE-ODD-EVEN switch	Set at ODD or EVEN to corres- pond to transmitting channel.
	PCM INPUT LEVELS control	Position same as recorded during system lineup.
	FDM INPUT LEVELS control	Position same as recorded during lineup.
	AFC TUNE CHANNEL Indicator	Same as transmitting channel.
	<i>Multimeter selector switch position:</i>	Compare meter reading with reading recorded while performing system lineup.
	OSC position	Reading recorded durning system lineup.
	MAIN TUNE position	Reading recorded durning system lineup.
	MIXER position	Reading recorded durning system lineup.
	AMP position	Reading recorded durning system lineup.
	OUT FREQ position	Reading recorded durning system lineup.
	PWR OUT position	Reading recorded durning system lineup.
	REF PWR	Reading recorded durning system lineup.
	AFC LEV position	Reading recorded durning system lineup.

1KC IN	Green area when 1-kc test signal is sent from multiplex terminal
1KC MOD	Green area when 1-kc test signal IS sent from multiplex terminal or when receiver TEST TONE switch IS operated to ON
68KC IN	Green area when fdm equipment is connected to radio set
68KC MOD	Green area when fdm equipment is connected to radio set
PCM IN	Reading recorded when PCM was connected to transmitter
TEST	Paragraph 5-13b
TEST TONE switch	OFF
TEST TONE control	Counterclockwise position
Multimeter selector switch position:	Compare meter reading with reading recorded while performing system lineup
OSC	Reading recorded during system lineup
AFC LEV (R-1148(P)/GRC only)	Reading recorded during system lineup
REC SIGNAL	Reading recorded during system lineup
TEST TONE CAL	Green area when TEST TONE switch is set to ON and control Is adjusted.
ORDER WIRE	Green area when distant radio station or multiplex terminal sends 1-kc test signal
1KC OUT	Green area when distant radio station or multiplex terminal sends 1-kc test signal
68KC OUT	Green area when fdm equipment connected to distant radio set
PCM OUT	Green area when pcm equipment connected to distant radio set
TEST	See para 5-13

3-20. Stopping Procedure

The radio set may be placed in standby or completely turned off. Normally, the stopping procedure takes from 2 to 3 minutes. In an emergency, the radio set may be stopped immediately.

a. Standby. To place the radio set in standby, place the PP-2054(*)/GRC OPERATE-STANDBY switch al STANDBY. This action will remove the direct current (dc) potentials (filaments are left on) from the transmitter The receiver will remain on.

b. Normal Stopping. The normal stopping procedure for the radio set is listed below. Use this procedure only when the equipment is to be off for 2 hours or longer. For periods of less than 2 hours, place the equipment in standby.

Component Control Position	R-1148(P)/GRC or R-1331(*) (P)/GRC	AC POWER ON-OFF
OFF	R-1 148(P)/GRC.	AFC selector switch
TUNE	PP-2054(*)/GRC	OPERATE-STANDBY
STANDBY (for 2 or 3 minutes)	PP-2054(*)/GRC	AC POWER .
OFF	T-893(P)/GRC	AFC selector switch
TUNE	CN-514/GRC	POWER ON-OFF
OFF		

e. Emergency Stopping. To turn off the radio set m R- 1331 (*) (P)/GRC, PP-2054 (*) /GRC, and an emergency, place the R-1148(P)/GRC, or CN-514/GRC AC POWER switches at OFF

Component	Item Indication	Blower motor	Operating
Receiver with AM-1955(*)/GRC or AM-1956(*)/GRC		WAVEMETER	Set within two divisions of required setting according to WAVEMETER CHART
		OSCILLATOR contra	Locked
		REC SIG-I control	Locked

Component	Item	Indication
	SQUELCH control.....	Position same as recorded during system lineup
	NO SIGNAL lamp	Not lighted
	AFC TUNE CHANNEL indicator (R-1 148(P)/GRC only)	Same as receiving channel
	AFC TUNE-ODD-EVEN switch (R- 1148(P)/GRC only)	Set at ODD or EVEN to correspond to receiving channel
	FDM OUTPUT LEVEL control	Position same as recorded during system lineup
	RING push-button.....	When depressed 1600 cps tone heard in H-156/U.

CHAPTER 4

OPERATOR'S MAINTENANCE

4-1. Scope of Operator's Maintenance

a. The following is a list of maintenance duties normally performed by the operator of the radio set. These procedures do not require special tools or test equipment.

b. Operator's maintenance for the radio set consists of the following:

- (1) Preventive maintenance (paras 4-2- 4-6).
- (2) Visual inspection (para 4-7).
- (3) Operational check (para 4-8).
- (4) Replacement of indicator lamps (para 4-9).
- (5) Replacement of fuses (para 4-10).

4-2. Operator's Preventive Maintenance

Preventive maintenance is the systematic care, servicing, and inspection of equipment to prevent the occurrence of trouble, to reduce downtime, and to assure that the equipment is serviceable.

a. Systematic Care. The procedures given in paragraphs 4-3 through 4-6 cover routine systems and care and cleaning essential to proper upkeep and operation of the equipment.

b. Preventive Maintenance Checks and Services. The preventive maintenance! checks and services charts (paras 4-3 and 4-5) outline functions to be performed at specific intervals. These checks and services are to maintain Army electronic equipment in a combat serviceable condition; that is in good general (physical) condition and in good operating condition. To assist operator in maintaining combat serviceability, the charts indicate what to check, how to check, and the normal conditions; the references column lists the illustrations, paragraphs, or manuals that contain supplementary information. If the defect cannot be remedied by the operator, higher category maintenance or repair is required. Records and reports of these checks and services must be made in accordance with the requirements set forth in TM 38-750.

4-3. Preventive Maintenance Checks and Services Periods

Preventive maintenance checks and services are required daily and weekly Paragraphs 4 and 4-5 specify the items to be inspected and serviced.

a. Paragraph 4-4 specifies the items to be checked and serviced daily. In addition to daily checks, the equipment should be re-inspected and serviced immediately before going on a mission and as soon after the completion of the mission as possible.

b. Paragraph 4-5 specifies the items to be checked and serviced once each week. If the equipment is maintained in a standby condition, the daily and weekly services and inspections should be accomplished at the same time.

4-4. Daily Preventive Maintenance Checks and Services Chart

Sequence No.	Item to be inspected	Procedures	References
1	Radio set	Cleans cases, cables, and frost panels Para 4 -6	
2	Cables	Check all cables for cables for tight connection to receptacles.	
3	Controls	None. a. During tuning operations, note any switch or control that does not operate smoothly and lock into position. a. Higher category of maintenance required.	
4	Operation	Check the condition of indicator lights and meter indications. See para 3-19.	
5	Filters	Check the condition of the filters in the transmitter and in the receiver. Para 4-11.	

4-5. Weekly Preventive Maintenance Checks and Services Chart

Sequence No.	Item to be inspected	Procedures	References
1	Antenna system -----	a. Tighten any guys that are not properly tensioned. b. Reset any stakes that are not firmly in the earth c. Check to see that the antenna cables is not endangered by, or is a danger to vehicles and pedestrians.	TM 11-5820-538-12
2	Mounting screws -----	a. Tighten all screws holding chassis in cases. b. Tighten all screws holding cases and cables in the shelter.	a. None b. None
3	Metal surfaces -----	a. Check all metal surfaces for rust and corrosion. a. Para 4-6. Higher maintenance services required if painting is necessary b. Check AB-577/GRC launcher for rust and corrosion. b. Same as a above.	b. TM 38-750.
4	Cables -----	a. Check all cables for cuts and kinks and for broken insulation. b. Temporarily tape open cable insulation and report defect to higher maintenance category.	a. None
5	Wavemeters -----	a. Check to see that the charts are attached to each wavemeter with the nylon cord. a. Higher maintenance b. Check to see that serial numbers on the charts are the same as the numbers on the wavemeter dial.	b. Higher maintenance services
6	Transmitter -----	Check the voltages of the current regulator circuits and adjust if necessary.	Para 5-13b(2).
7	Filters -----	Check the condition of the filters in the transmitter and receiver.	Para 4-11.

4-6. Cleaning

Inspect the exteriors of the radio set. The exteriors should be free of dust, dirt grease, and fungus.

- a. Remove dust and loose dirt with a clean, soft cloth.

WARNING

Cleaning compound trichloroethane (Federal stock No. 6810-292-9625; 1 qt) is toxic. Provide thorough ventilation when it is used. **DO NOT USE NEAR AN OPEN FLAME.** It is not flammable, but exposure of the fumes to a flame converts the fumes to highly toxic and dangerous gases.

- b. Remove grease, fungus, and ground-in dirt from surfaces; use a cloth dampened (not wet) with cleaning compound.
- c. Remove dirt from plugs and jacks with a brush.
- d. A cloth dampened with water and soap is effective in cleaning surfaces and cables.

4-7. Visual Inspection

- a. When the equipment fails to perform properly, check the items listed below.
 - (1) Check for improper settings of switches and controls.
 - (2) Check antenna lead-in cable for breaks and loose connections. Check the looseness of the cable CG-718B/U between the transmitter and receiver (fig. 6-3).
 - (3) Improper channel selection (para 2 3).
- b. If the above checks do not identify the trouble, proceed to the operational checklist (para 4 8).

4-8. Operational Checklist

a. *General.* The operational checklist consists of preliminary starting and operating procedures and is supplemental to the operator's repair procedures (paras 4-9, 4-10, and 4-11). The corrective measures listed are those the operator can perform. When no corrective measures are listed or if the measures recommended do not restore normal equipment performance, troubleshooting is required by higher maintenance category. Note on the repair tag what corrective measures were performed at the time of the failure.

b. *Procedure.* To check the operation of the equipment, perform the operations given in c and d below. Do not proceed to later steps until the abnormal condition is corrected. Before proceeding with the checks, turn off all of the equipment and notify the other stations in the system of the situation.

c. *Conditions.* The following operational conditions are based on the following conditions:

- (1) Set the PP-2054(*)/GRC OPERATE-STANDBY switch to STANDBY and connect the DA-189/GRC to the transmitter.
- (2) The loop-back testing procedures will be used to make the operational check of the transmitter, receiver, and multiplex equipment (para 3-11). If possible, use the assigned transmitting channel and tune the receiver 120 channels above the transmitting channel. If this is not possible, select channels that are 120 channels apart.

d. *Checklist.* The receiver in the following checklist refers to R-1148(P)/GRC or R1331(*)/GRC; the amplifier-oscillator refers to the AM-1957/GRC or AM-1958(*)/GRC in the transmitter; and the amplifier-converter refers to the AM-1955(*)/GRC or AM-1956(*)/GRC in the receiver.

Step	Component	Action	Normal Indication	Corrective Measures
1	Radio receiver	Perform receiver operations given in steps 1 through 7, paragraph 3-8.	None.....	None.
2	CN-514/GRC.....	Set POWER switch to ON	POWER ON indicator lights.	Check power cable connections. Replace POWER ON indicator lamp.
3	CN-5 14/GRC.....	Set MANUAL-AUTO-	Meter indicates voltage.	Replace MANUAL indica-

Step	Component	Action	Normal Indication	Corrective Measures
4	CN-514/GRC	Set RAISE-LOWER switch to RAISE then to LOWER	Meter indicates increase in voltage then decrease in voltage.	Check MOTOR 1 AMP fuse; replace if defective (para 4-10).
5	CN-514/GRC	Set MANUAL-AUTOMATIC switch to AUTOMATIC.		
6	Radio receiver		MANUAL indicators lamp goes out. Meter indicates a voltage change and settles at 115 volts.	If abnormal indications are obtained, higher maintenance services are required.
7	Transmitter	Check CONTROL 1 AMP fuse, replace if defective (para 4-10)	PP-2054(*)/GRC	Set OPERATE-STANDBY switch to STANDBY. Set AC POWER switch ON
8	Replace LOW POWER indicator lamp (para 4-9).	If abnormal indications are obtained, higher maintenance services are required.	AC POWER indicator lights. The INCOMING CALL indicator lamp may light and buzzer sound; after a few seconds, the lamp goes out and the buzzer should stop sounding.	Refer to paragraph 3-11b and perform operations in steps 5, 6, 9, and 10.
9	Check two 5 AMPS fuses; replace if defective (para 4-10). Replace AC POWER indicator lamp (para 4-9).	FIL indicator lights and blower motors in PP-2054(*)/GRC and transmitter run.	Replace FIL lamp (para 4-9). If blower motors do not run, check cable connections to CN-514/GRC and transmitter. Check 5 AMP FIL fuse (para 4-10).	None.
10	Transmitter	At least 15 minutes after step 6, set OPERATE-STANDBY switch to OPERATE.	PP-2054(*)/GRC	Normal indications are given in turning procedures.
11	Receiver	The LV and HV indicator lamps light.	Note position of LOW POWER ALARM ADJUST control, and rotate it until LOW POWER indicator lights; then reset to original position. Silence buzzer by operating BUZ OFF push-button.	Set AC POWER switch to ON. Note: Before turning on the receiver, make sure it has been turned off for at least 5 minutes.
	Refer to paragraph 3-11b, step 11 and tune receiver.	Check tightness of target bolt (fig 1-4). If LV indicator does not light, check 3 AMP LV fuse (para 4-10). Replace LV indicator lamp. If HV Indicator does not light, check 3 AMP HV fuse. (This fuse, even when equipment is marked with 5 AMP, should be 3-amp, time-delay fuse in all equipments (para 1-14f). Replace if defective (para 4-10). Replace HV indicator lamp (para 4-9).	LOW POWER indicator lights and buzzer sounds. Buzzer is silenced when BUZ OFF push-button is operated.	Normal indications are given in tuning procedure.

Step	Component	Action	Normal Indication	Corrective Measures
12	Transmitter receiver and multiplex equipment.	Refer to paragraph 3-11b and perform operations given in steps 12 through 20.	Normal indications are given in the local test procedures.	When the required indications are not obtained on the radio transmitter and receiver multimeters during checks of the pcm (or fdm) multiplex circuits (para 3-14 or 3-13), check the multiplex equipment cable connections at the radio and at the multiplex equipment. Perform local troubleshooting checks at the multiplex equipment.

4-9. Replacement of Indicator lamps

a. The following indicator lamps may be replaced by the operator.

NOTE

Type 327 lamp is used in the CN-514/GRC. All other components use type 328 lamps. Do not interchange lamp types.

Unit	Indicator
CN-5 14/GRC Receiver	POWER ON MANUAL AC POWER INCOMING CALL NO SIGNAL
PP-2054(*)/GRC Transmitter	FIL LV HV LOW POWER

b. Replace the indicator lamps as follows:

- (1) Turn the lampholder counterclockwise and remove it from the receptacle.
- (2) Remove the defective lamp from the lampholder.
- (3) Insert the replacement lamp in the lampholder.

Replace the lampholder in its receptacle and tighten the holder by turning it clockwise.

4-10. Replacement of Fuses

a. The following fuses may be replaced by the operator:

Unit	Indicator
CN-514/GRC Receiver	MOTOR 1 AMP CONTROL 1 AMP Fuses F1 and F2 (fig. 5-11); 20 amperes AC POWER 5 AMPS
PP-2064(*)/GRC	FIL 5 AMP LV 3 AMP HV 3 AMP (This fuse will be 3 amp time-delay fuse even on those units that have HV 5 AMP marked on the front panel; see para 1-14g)

*Fuses F1 and F2 (fig. 5-11) (20 amps) protect the CN-514/GRC from overload from equipment connected to the utility outlets on the left of CN-514/GRC front panel (fig. 3-8).

b. Replace the fuse as follows:

- (1) Remove the fuse holder from its socket; remove the fuse from the fuse holder.
- (2) To replace the fuse, insert the replacement fuse in the fuse holder, and replace the fuse holder in its socket.

4-11. Replacement of Air Filter

CAUTIONS

1. Observe the precaution marked on the filter screens: KEEP CLEAN.
2. Do not operate the equipment without a filter. The filters in the transmitter (fig. 3-1), receiver (figs. 3-5 and 3-6), and PP-2054(*)/GRC (fig. 3-4) should be free of clogging dust and dirt. To make sure that they are in this

TM 11-5820-461-12

condition, they should be removed and cleaned by tapping and shaking to remove the accumulated dust and dirt (para 5-6c(3)).

a. In dusty and damp areas, the cleaning procedures should be performed daily. In other areas, the cleaning operation should be performed at least weekly.

b. When the filter appears clogged and cleaning operations are ineffective in removing dust and dirt, replace the filter.

CHAPTER 5 ORGANIZATIONAL MAINTENANCE

Section I. MAINTENANCE

5-1. Scope of Organizational Maintenance

Organizational maintenance includes preventive maintenance (paras 5-2 through 5-7), troubleshooting (paras 5-8 through 5-14), and repairs (para 5-15).

5-2. Tools, Materials, and Test Equipment Required

Refer to TM 11-5820-461-25P for those items of the radio set that are authorized for replacement at organizational maintenance. The materials, tools, and test equipment are listed in a, b, and c below.

a. Materials.

WARNING

Adequate ventilation should be provided while using TRICHLOROTRIFLUOROETHANE. Prolonged breathing of vapor should be avoided. The solvent should not be used near heat or open flame; the products of decomposition are toxic and irritating. Since TRICHLOROTRIFLUOROETHANE dissolves natural oils, prolonged contact with skin should be avoided. When necessary, use gloves which the solvent cannot penetrate. If the solvent is taken internally, consult a physician immediately.

- (1) Cleaning Compound, trichlorotrifluoroethane
- (2) Cleaning cloth
- (3) Sandpaper, No. 000.
- (4) Grease, Aircraft and Instrument (GL) (NSN 9150-00-985-7245).

b. Tools.

- (1) 5/16-inch socket wrench.
- (2) 7/6-inch socket wrench.
- (3) 4 inch screwdriver.
- (4) 3-inch screwdriver.
- (5) Tube puller TL-201.
- (6) Tube puller (7-pin miniature).
- (7) Tube puller (9-pin miniature).
- (8) Tube puller for 3CX100A5, 7289, 7211.
- (9) Tool Kit TK-101/G.
- (10) Maintenance test leads.
- (11) Small brush.
- (12) Trouble lamp.

NOTE

With the exception of Tool Kit TK-101/G and the small brush, all these tools are located in Accessory flay BG-102A and in Case, Standardized Components, Electrical CY-2583/GRC.

c. Test Equipment.

- (1) Multimeter AN/URM-105.
- (2) Test Set, Electron Tube TV-7(*)/U.
- (3) Dummy Load, Electrical DA-189/GRC (part of radio set).

5-3. Organizational Preventive Maintenance

a. Preventive maintenance is the systematic care, inspection, and servicing of the equipment to maintain it in serviceable condition, prevent breakdowns, and insure maximum operational capability. Preventive maintenance is the responsibility of all maintenance categories concerned with the equipment, and includes the inspection, testing and repair or replacement of parts, subassemblies, or units that inspection and tests indicate would probably fail before the next scheduled periodic service. Preventive maintenance service and inspection of the radio set at organizational category are made quarterly unless otherwise directed by the commanding officer.

b. Maintenance forms and records to be used and maintained on this equipment are specified in TM 38-750.

5-4. Quarterly Maintenance

Quarterly maintenance on the radio set will be scheduled in accordance with the requirements of TM 38-750. All deficiencies or shortcomings will be recorded, and those not corrected during the inspection and service will be immediately reported to higher maintenance category by use of forms and procedures specified in TM 38-750. Equipment that has a deficiency that cannot be corrected by organizational personnel should be deadlined in accordance with TM 38-750. Perform all the services listed in the quarterly maintenance and inspection chart (para 5-5)

TM 11-5820-461-12

in the sequence listed. Whenever a *normal condition* or *result* is not observed, take a corrective action in accordance with the paragraph or figure listed under *references*, or refer to higher maintenance category.

5-5. Quarterly Maintenance Service and Inspection Chart

Sequence No.	Procedure		References
	Item to be inspected	Normal Indication or result	
1	<p>Set: Inspect the equipment for:</p> <ul style="list-style-type: none"> a. Completeness b. Proper installation c. Cleanliness <p>d. Preservation</p> <ul style="list-style-type: none"> a. Equipment must be complete b. Equipment is properly installed c. Radio set must be clean inside and out, and free of dust, dirt, grease, and fungus. d. Painted surfaces must be free of bare spots, rust, and corrosion, equipment markings must be legible. Touchup where necessary. 	<p>c. DA Pam 310-4</p>	<ul style="list-style-type: none"> a. None. b. Para 5-6. 9 <p>The fuses and the spares should be of the indicated value and located as follows:</p> <ul style="list-style-type: none"> a. Regulator, Voltage CN-514/GRC front panel: MOTOR: 1 ea. 1 amp. CONTROL: 1 ea. 1 amp. inside: F1, F2: 20 amp.
2	<p>PUBLICATIONS. See that pertinent publications are available.</p> <ul style="list-style-type: none"> a. Organizational maintenance manual must be complete and serviceable. b. Repair parts and special tools list. must be complete and serviceable. c. All changes pertinent to the equipment must be on hand. <p>a. DA Pam 310-4, TM 11-5820-461-12</p>		<ul style="list-style-type: none"> b. Radio receiver: AC POWER: 2 ea. 5 amp. c. Power Supply PP-2054(*)/GRC front panel: FIL: 1 ea. 5 amp. LV: 1 ea. 3 amp. HV: 1 ea 3 amp (para 1-14g). c. Para 4-6.
3	<p>MODIFICATION WORK ORDERS: Check DA Pam 310-7 to determine If new applicable MWO's have been published.</p>	<p>All URGENT MWO's have been applied to the equipment. All NORMAL MWO's. have been scheduled.</p>	
4	<p>LUBRICATION: Perform a complete lubrication of the equipment.</p>	<p>Mechanisms do not show signs of overlubrication or underlubrication.</p>	<ul style="list-style-type: none"> d. Para 5 6d and TB 746-10.
5	<p>CONNECTIONS: Inspect interior wiring for abrasions and broken or loose connections.</p>	<p>Binding posts have sufficient tension to hold wire. Wiring has no abrasions.</p>	
6	<p>KNOBS, DIALS, AND SWITCHES: Check for proper mechanical action by setting each control to each of its positions.</p>	<p>Action is positive without backlash, looseness, binding, or scraping.</p>	
7	<p>PLUCHOUT ITEMS: Inspect vacuum tubes, lamps, and crystals for proper seating and visible damage</p>	<p>Vacuum tubes, lamps and crystals are securely mounted There is no visible damage.</p>	
8	<p>CIRCUIT BREAKERS: (Power Supply PP-2054(*)/GRC and Regulator age CN-514/GRC.) Inspect circuit breakers for loose mounting hardware, corroded contacts, and loose electrical connections.</p>		<ul style="list-style-type: none"> b. TM 11-5820-461-25P
9	<p>FUSES: Check for proper fuses</p>		<p>Para 4-10.</p>

Sequence No.	Procedure		References
	Item to be inspected	Normal Indication or result	
10	ANTENNA: Inspect the antenna assembly for damage, proper installation, and proper guy wire tension	a. The antenna assembly is complete and properly installed. b. There must be no damage to the launcher frame, mast sections, Antenna AT-903/G, the winch assembly, cable reels, and cables.	a. TM 11-5820-538-12. b. None.
11	NORMAL OPERATION: Check the operation of the equipment by the use of the checklist	There is no evidence of malfunction when the procedures in the checklist are performed.	Para 5-11
12	PP-2054(*)/GRC VOLTAGES	Check the output voltages of the power supply; perform the required adjustments.	Para 5-13a
13	TRANSMITTER TESTS: a. Current regulator circuits of amplifier-oscillator tubes. b. Voltages of modulator assembly 2A5 and afc assembly 2A4.	a. Check the current regulator circuits; perform required adjustments. b. Check the voltages of the two assemblies; perform required adjustments	a. Para 5-13b. b. Para 5-13c
14	RECEIVER TESTS: a. Power supplies b. Amplifier converter and crystal mixer CRT. c. R-1148(P)/GRC only: afc assembly	a. Check the power supply voltages, perform required adjustments b. Check the unit for required indications. c. Check the unit for required indications.	a. Para 5-13d. b. Para 5-13e c. Para 5-13f

5-6. Additional Maintenance Items

a. *Chain Linkage.* Inspect the chain linkage in Regulator, Voltage CN-514/GRC for dirt, rust, corrosion, or loose and worn links. Remove dirt with a cleaning cloth dipped in cleaning compound. Remove rust or corrosion with fine sandpaper. If any sanding is performed, wipe abraded area thoroughly with a cleaning cloth dipped in cleaning compound; then coat the area lightly with grease (GL). If links are loose or worn excessively, higher category of maintenance is required.

b. *Gears /and Shafts.* Check the gears, shafts, and couplings of afc assemblies 2A4/3A4 (figs. 6-4 and 6-6), modulator assembly 2A5 (fig. IN Amplifier-Converters AM-1955(*)/GRC and AM-1956(*)/GRC, and Amplifier-Oscillators AM-1957JGRC and AM-1958(*)/GRC for dirt, rust, or corrosion, and evidence of wear. If the gears, shafts, or couplings are excessively worn, higher category of maintenance is required.

c. *Cleaning.* Clean the radio set as follows:

WARNING

The fumes of cleaning compound trichloroethane (FSN 6810-292-9625; 1 at) are toxic. Provide enough ventilation whenever used. DO NOT use near an open flame. Trichloroethane is not flammable but exposure to the open flame converts the fumes to a highly toxic, and dangerous gas.

(1) Remove dirt from terminal blocks and lightning arrestors with a cleaning cloth and cleaning compound.

(2) Use a cleaning cloth dipped in cleaning compound to remove the dirt and dust from the exterior surfaces and fan blades of blower motors In the PP-2054(*)/GRC, T-893(P)/GRC, R-1148(P)/GRC, R-1331(*) (P)/GRC, and the synchomotors in modulator assembly 2A5.

(3) Remove dust and dirt from the air filters by tapping the filter on a solid surface. If compressed air IS available, blow the dust and dirt out by directing the airflow over the surface of the filter. Clean the surface with a cleaning cloth dipped in cleaning compound.

NOTE

To remove the air filters from their housing loosen the fasteners of the air filters from the component. After cleaning, replace the air filter in the housing and tighten the fasteners.

d. Painting. Remove rust and corrosion from metal surfaces by lightly brushing them with sandpaper. Brush two thin coats of paint on the bare metal to protect it from further corrosion. Refer to applicable cleaning and refinishing practices in TB 746-10.

5-7. Lubrication

The symbol Q appearing in the illustrations showing the lubrication points of the radio set stands for a period of 3 months. A 8-month interval consists of 90 days of normal 8-hour operation. If the equipment is operated more than 8 hours a DA>, the lubrication inspection intervals will have to be adjusted to prevent active wear. *For example* if the radio set is operated 16 hours a day instead of 8, inspection for lubrication will be necessary, and new lubrication applied as required every 45 days instead of every 90 days.

CAUTION

Do not apply grease to any part that enters any cavity during tuning or operation of the radio set.

a. Amplifier-Oscillator AM-1957/GRC and AM-1958(*)/GRC. Loosen the front panel mounting screws on the AM-19571GRC or the AM-1958(*)1GRC and remove it from the T -8 93(P)/GRC. Locate all the points to be lubricated (fig. 5-1) and clean them with a brush dipped in cleaning compound. Use a clean brush to apply a light film of grease ((GL) to the points indicated. Replace the components and tighten the mounting screws.

b. Amplifier-Converters AM-1953(*)/GRC and AM-1956(*)/GRC. Loosen the front panel mounting screws on the AM-1955(*)/GRC or the AM-1956(*)/GRC and remove it from the R-1148(P3)/GRC or the R-1381(*)/GRC. Locate all points to be lubricated and clean them with a brush dipped in cleaning compound (fig. 5-2). Apply a light film of grease (GL) with a clean brush to the points indicated. Replace the AM-1955(*)/GRC or the AM-1956(*)/GRC and tighten the front panel mounting screws.

c. Regulator, Voltage CN-514/GRC Loosen the mounting screws that attach the CN-514/GRC to the component case and remove the CN-514/GRC from the component case. Clean the sprockets and the chain with a brush dipped in cleaning compound (fig. 5-3). Apply a light film of grease (GL) to the sprockets and chain with a clean brush.

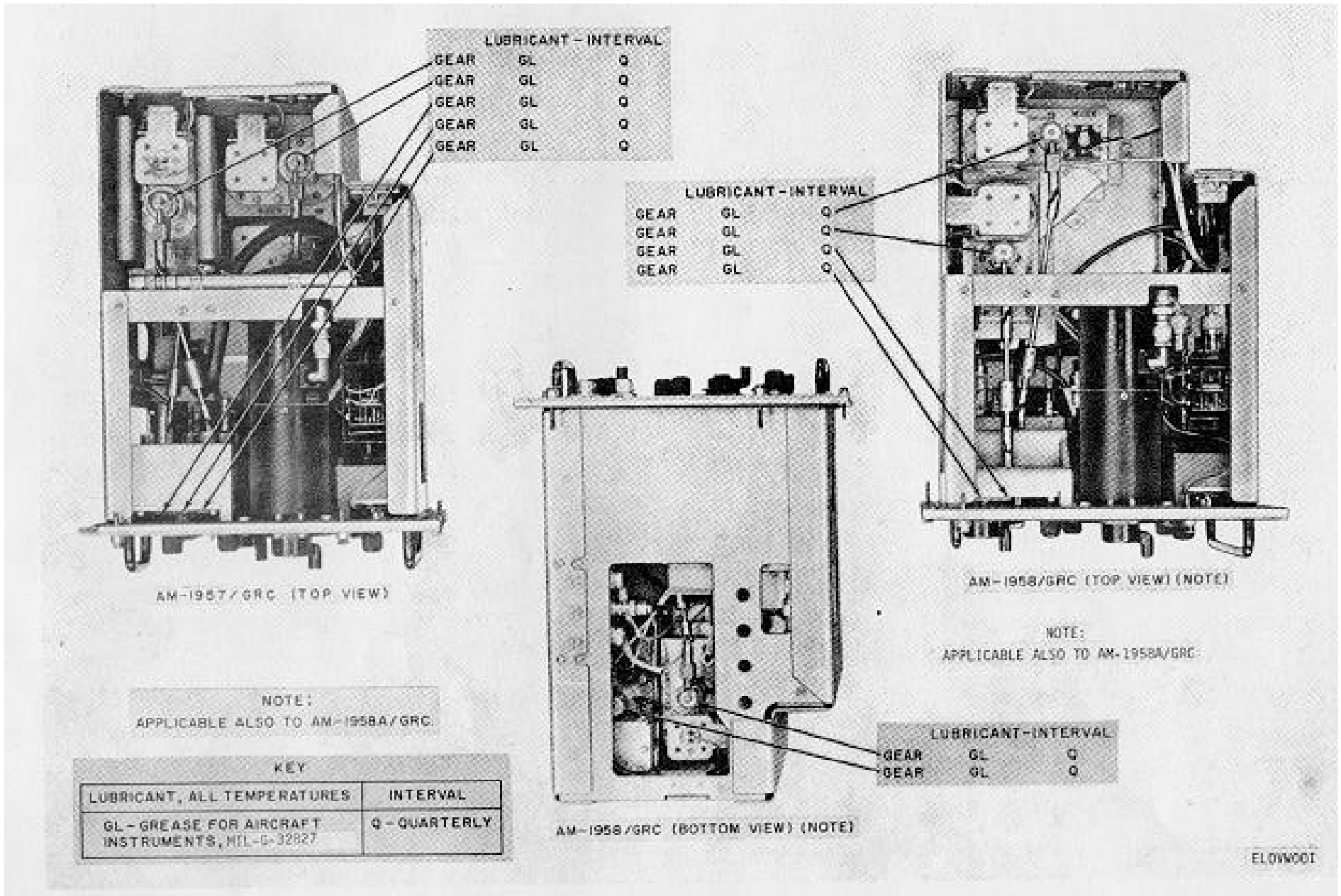

Figure 5-1. Amplifier-Oscillators AM-1957/GRC and AM-1958(*)/GRC, lubrication points.

Change 7 5-4.1/5-4.2 (blank)

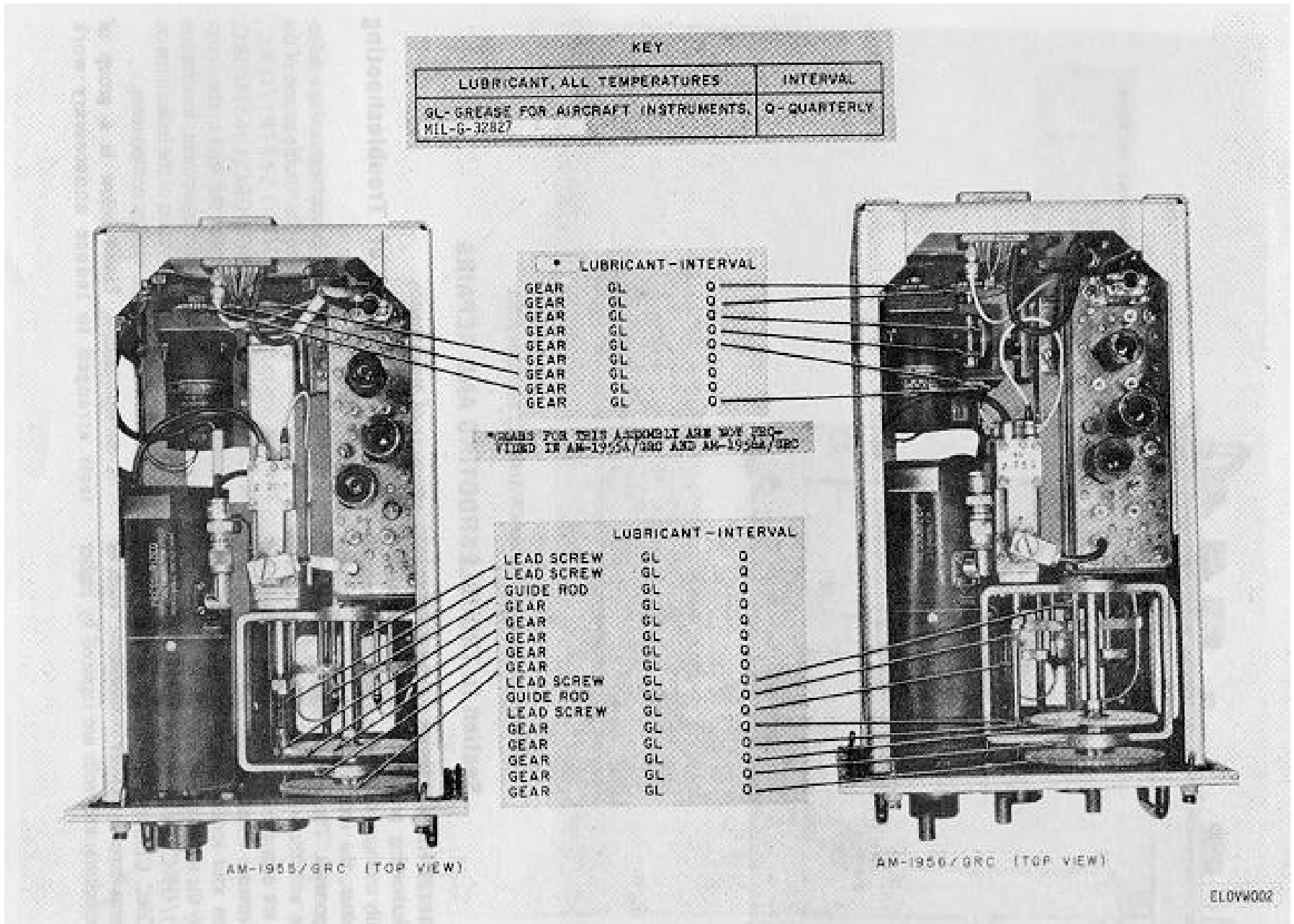

Figure 5-2. Amplifier-Oscillators AM-1955(*)/GRC and AM-1956(*)/GRC, lubrication points.

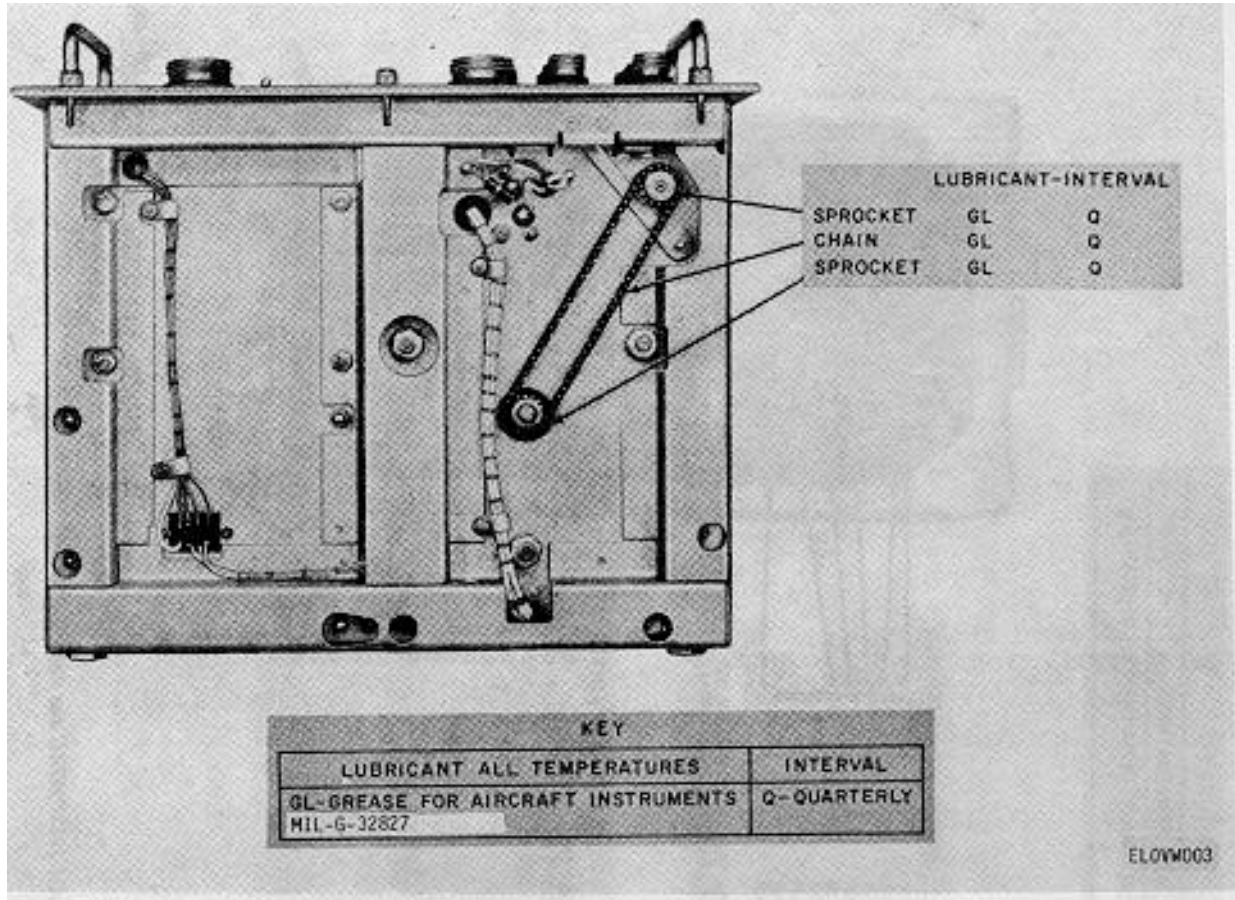

Figure 5-3. Regulator, Voltage CN-514/GRC, lubrication points.

Section II. TROUBLESHOOTING AND REPAIRS

5-8. General Instructions

The troubleshooting procedures in this manual are systematically arranged to provide detailed coverage of the transmitter, the receiver, the plug-in units, and other components. The troubleshooting procedures, which begin with the operational check at the operator's level are expanded through the use of an equipment performance checklist (para 5-11), and by sectionalization and localization. Troubleshooting is simplified by the use of the built-in multimeters on the R- 1148 (P) /GRC or R- 13 31 (*) (P) /GRC and T-893(P)/GRC. Component replacement is limited to pluckout items (app B). Other components, such as resistors, capacitors, and coils are replaced by higher category of maintenance.

5-9. Organization of Troubleshooting Procedures

a. General. The first step in troubleshooting a defective radio set is to sectionalize the trouble to one of the major components (R-1148(P)/GRC, R-1331 (*) (P)/GRC, T-893(P)/GRC, CN-514/GRC, etc). The next step is to localize the fault in the defective major component. In this equipment, localization may be performed by observation of the indications on the built-in meters in the various components.

b. Sectionalization. Listed below is a group of tests arranged to reduce unnecessary work and to aid in tracing troubles to a defective major component within the radio set. To locate the unit at fault, proceed as follows:

and to aid in tracing troubles to a defective major component within the radio set. To locate the unit at fault, proceed as follows:

(1) *Visual inspection.* The purpose of visual inspection is to locate faults without testing or measuring circuits. Observe all meter readings or other visual signs and attempt to sectionalize the fault to one of the major units. Refer to paragraph 5-8 for trouble sectionalizing by use of the front panel indications.

(2) *Operational tests.* Operational tests frequently indicate the general location of trouble. In many instances, the tests will help to determine the exact nature of the fault. The equipment performance checklist (para 5-11) is a good operational check.

c. Localization.

(1) *Voltage and current measurements.* A set of tests and adjustments, by the use of panel-mounted meters, is provided in paragraph 5-13. These tests recommend specific adjustment or repair procedures.

(2) *Intermittent troubles.* In all these tests, do not overlook the possibility of intermittent troubles. If present, this type of trouble often may be made to appear by tapping or jarring the equipment. Check the interconnecting cables for firm seating.

5-10. Visual Inspection

NOTE

Turn off all power before proceeding with the inspection.

When equipment failure occurs, inspect the equipment carefully before performing detailed troubleshooting procedures. This will save time and may also avoid further damage. Loosen the captive screws that hold the component to the component case. Remove the component partially from the component case and inspect it for the defects listed below.

- a. Improperly seated assemblies.
- b. Worn, broken, or disconnected cords or connectors.
- c. Improperly connected cords or connectors.
- d. Broken wires or parts because of strain or excessive vibration.
- e. Broken or cracked tubes.
- f. Defective operation of switches and controls.
- g. Improper setting of operating frequency.
- h. Discolored or blistered resistors, capacitors, and silicone rectifiers.
- i. Cracked glass seals on hermetically sealed components.

5-11. Equipment Performance Checklist

a. *General.* The equipment performance checklist is a procedure to systematically check equipment performance. All corrective measures that the organizational repairmen can perform are given in the Corrective measures column. When using the checklist, follow each step in the order given. If the corrective measures indicated do not restore normal performance, or if no corrective measures are given, troubleshooting is required by higher category of maintenance. Note on the repair tag how the equipment performed and what corrective measures were taken.

NOTE

Refer to paragraph 5-14 for the tube replacement procedures.

- (1) Select test channels so that receiving channel is 120 channels above transmitting channel (para 3-11a).
- (2) Connect DA-189/GRC to transmitter.

TM 11-5820-461-12

b. Checklist

PREPARATORY

Step	Unit	Action	Normal indication	Corrective measures
1	CN-514/GRC	Set POWER ON-OFF circuit breaker to OFF.		
2	CN-514/GRC	Set MANUAL-AUTOMATIC switch to MANUAL.		
3	PP-2054/GRC	Set AC POWER circuit breaker to OFF.		
4	PP-2054/GRC	Set OPERATE-STANDBY switch to STANDBY.		
5	T-893(P)/GRC	Set multimeter selector switch to TEST.		
6	T-893(P)/GRC	Rotate AFC CORRECTION control to midrange.		
7	T-893(P)/GRC	Set AFC TUNE-ODD-EVEN switch to TUNE.		
8	T-893(P)/GRC	Rotate PCM INPUT Levels control to midrange.		
9	T-893(P)/GRC	ROTATE FDM INPUT LEVELS control to midrange.		
10	T-893(P)/GRC (fdm only)	Set TRAFFIC CHAN switch to 12/24 or 4, depending on channel operation desired.		
11	T-893(P)/GRC	Set AFC TUNE control to desired channel.		
12	AM-1957/GRC or AM-1958(*) /GRC	Set MAIN TUNING control to desired channel.		
13	AM-1957/GRC or AM-1958(*) /GRC	Rotate WAVEMETER control to indication listed under MAIN TUNE column of WAVEMETER CHART corresponding to desired channel.		
14	AM-1957/GRC or AM-1958(*) /GRC	Rotate COUPLING control to desired channel.		

Caution: To avoid burning out receiver crystal, do not tune the POWER OUT control through, or closer than 15 channels to, receiver channels. Refer to paragraph 2-3a for other frequency restrictions. Observe cautions given on page 3-13.

15	AM-1957/GRC or AM-1958(*) /GRC.	Rotate REC SIG-2 control to desired channel indicated on RECEIVE CHANNEL dial.		
16	AM-1957/GRC or AM-1958(*) /GRC	Rotate POWER OUT control to desired channel indicated on TRANSMIT CHANNEL dial.		

PREPARATORY

Step	Unit	Action	Normal indication	Corrective measures
17	R-1148(P)/GRC or R-1331(*) (P) /GRC.	Set AC POWER switch to OFF.		
18	R-1148(P)/GRC or R-1331(*) (P) /GRC.	Set meter selector switch to OFF (TRANSMIT)		
19	R-1148(P)/GRC or R-1331(*) (P) /GRC.	Rotate FDM OUTPUT LEVEL control to midrange.		
20	R-1148(P)/GRC or R-1331(*) (P) /GRC.	Set FDM OUTPUT TRAFFIC CHANS switch to 12/24 or 4, depending on number of channels to be received.		
21	R-1148(P)/GRC or R-1331(*) (P) /GRC.	Set TEST TONE ON-OFF switch to OFF		
22	R-1148(P)/GRC or R-1331(*) (P) /GRC.	Set TEST TONE control to counterclockwise position.		
23	R-1148(P)/GRC only. Omit this step if using Amplifier-Converter AM-1955A/GRC or AM-1956A/GRC in R-1148-(P)/GRC.	Set AFC TUNE-ODD-EVEN switch to TUNE.		
24	R-1148(P)/GRC only. Omit this step if using Amplifier-Converter AM-1955A/GRC or AM-1956A/GRC in R-1148 (P)/GRC.	Set AFC TUNE control to desired channel.		
25	R-1148(P)/GRC or R-1331(*) (P) /GRC.	Set SQUELCH INCR SENS control fully clockwise.		
26	AM-/655(*)/GRC or AM-1956(*)/ GRC.	Rotate WAVEMETER control to indication in WAVEMETER CHART that corresponds to desired channel.		

Caution: To avoid burning out receiver crystal, do not tune REC SIG-1, REC SIG-2, and the OSCILLATOR controls through, or closer than 16 channels to, transmitter channels. Refer to paragraph 2-3c for other frequency restrictions. Observe the cautions given on page 3-13.

27	AM-1955(*)/GRC or AM-1956(*)/ GRC.	Rotate REC SIG-1 control to desired channel.		
28	AM-1955(*)/GRC or AM-1956(*)/ GRC	Rotate OSCILLATOR control to desired channel.		

TM 11-5820-461-12

Step	Unit	Action	Normal indication	Corrective measures
29	AM-1955/GRC or AM-1956/GRC only.	Set AFC correction control to midrange.		
30	AM-1957/GRC or AM-1958 (*)/GRC	Connect the DA-189/GRC to ANT connector.		

EQUIPMENT PERFORMANCE

Step	Unit	Action	Normal indication	Corrective measures
31	CN-514/GRC	Set POWER circuit breaker to ON.	<i>POWER ON indicator light.</i> MANUAL indicator lights.	Check power source output and power cable connections. Check POWER ON indicator lamp. Check MANUAL indicator lamp <i>Check MOTOR 1 AMP fuse</i>
32	CN-514/GRC	Set MANUAL RAISE-LOWER switch to RAISE then to LOWER.	Meter indicates raise in voltage then decrease in voltage.	
33	CN-514/GRC	Set MANUAL-AUTOMATIC switch to AUTOMATIC.	Meter indicates 115 volts. MANUAL indicator goes out.	
34	CN-514/GRC	Set MANUAL-AUTOMATIC switch to MANUAL and MANUAL RAISE-LOWER switch to LOWER until meter indicates approximately 105 volts. Then set MANUAL AUTOMATIC switch to AUTOMATIC. Repeat above except operate switch to RAISE until meter indicates approximately 120 volts.	Voltage indication on meter changes back to 115 volts in both operations.	Check CONTROL 1 AMP fuse. Check V1 and V2. Replace plug-in assembly.
35	PP-2054(*)/GRC	Set AC POWER circuit breaker to ON. Allow equipment to warm up for 5 minutes.	Blower motor operates. FIL indicator lights. Blower motor in T-893(P)/GRC operates.	Check 5 AMP FIL fuse. Check FIL indicator lamp. Check silicon rectifiers in PP-2054 (*)/GRC. If they are blistered or discolored, higher maintenance services are required. Check cable connection between TO XMTR on PP-2054 (*)/GRC and TO PWR SUP on T898(P)/GRC.
36	PP-2054(*)/GRC	Set OPERATE-STANDBY switch to OPERATE.	The LV and HV indicators light. Target bolt (interlock switch (fig. 1-4)) is tight; also all bolts holding amplifier-oscillator are tight. If buzzer sounds in T-893(P)/ GRC, silence it by operating BUZ OFF push-button.	If LV indicator does not light, check 3 AMP LV fuse. Check LV lamp. If HV indicator does not light, check HV fuse. (This fuse, whether equipment is marked with 6 AMP or 3 AMP should be replaced with 8 amp, time-delay fuse in all equipments (para 1-14g). Check HV lamp. Check V1.

EQUIPMENT PERFORMANCE

Step	Unit	Action	Normal indication	Corrective measures
37	AM-1958(*)/ GRC only.	Set multimeter selector switch to OSC and adjust OSC control for peak multimeter indication.	Peak indication is obtained. <i>Note</i> When meter needle goes off scale for any reading, depress METER SHUNT push-button and continue to adjust control for Peak indication.	Check V1. If V1 replace. Readjust R14 (para 5-13b).
38	AM-1957/GRC or AM-1958(*)/ GRC	Set multimeter selector switch on T-893(P)/GRC to MAIN TUNE and adjust MAIN tuning control for peak indication on multimeter.	Peak indication is obtained on multimeter.	Check V1. If V1 is replaced, readjust R14 (para 5-13b). Replace rectifier CR3 on wavemeter. Para 5-13c.
39	AM-1957/GRC or AM-1958(*)/ GRC.	Repeat steps 37 and 38. Lock MAIN TUNING control.		
40	AM-1957/GRC or AM-1958(*)/ GRC.	Set multimeter selector switch on T-893(P)/GRC to MIXER and adjust MIXER control for peak indication on multimeter.	Peak indication is obtained on multimeter. (If meter needle deflects off scale, press METER SHUNT push-button.)	Check V2. If V2 is replaced, readjust R15 (para 5-13b). If V2 does not help, do step 41 action and correction.
41	AM-1957/GRC or AM-1958(*)/GRC.	Rotate WAVEMETER control to indication listed under OUT FREQ column of WAVEMETER CHART that corresponds to desired transmitter channel. Set multimeter selector switch to T-893(P)/GRC to AMP, and adjust AMP control for peak indication on multimeter.	Peak indication is obtained on multimeter.	Check V3. If V3 is replaced, readjust R16 (para 5-13b).
42	T-893(P)/GRC	Set multimeter switch to AMP. Adjust AFC CORRECTION through its range for peak indication.	Peak indication is obtained on multimeter. AFC CORRECTION control is not over 10° from midrange.	If there is no meter indication, check V1 through V4 by substitution in assembly 2A4. If indication is now obtained, but AFC CORRECTION control is set more than 10° from midrange, check V1 and V2 by substitution in assembly 2A5 until one tube provides indication within 10° of midrange. If control is still more than 10°, check V6 and V7 by

Step	Unit	Action	Normal indication	Corrective measures
43	AM-1957/GRC or AM-1958(*)/GRC.	Set multimeter selector switch on T-893(P)/GRC to PWR OUT, and adjust POWER OUT control for peak Indication on DA-189/GRC meter. Adjust AMP, POWER OUT, and COUPLING controls until no further increase can be obtained on DA-189/GRC.	Peak indication is obtained on DA-189/GRC meter. Multimeter indicates peak deflection.	substitution in assembly 2A4 until the control is within 10° Note: Do not discard until unsatisfactory tubes; they may be used in other circuits satisfactorily. When multimeter indication is obtained, but DA-189/GRC meter shows no indication, open back of DA-189/GRC and replace diode with one of spares stowed in DA-189/GRC (fig 1-14).
44	AM-1957/GRC or AM-1958(*)/GRC.	Set multimeter selector switch to MIXER and adjust MIXER control to in-crease DA-189/GRC indication. Repeat adjustments in step 43 above.		
45	AM-1957/GRC.	Set multimeter selector switch to REF PWR. Carefully re-adjust POWER OUT control for maximum dip on multimeter within reducing DA-189/GRC Indication. On AM-1957/GRC only, if two dips occur on the multimeter, adjust the control to peak indication between dips.		
46	AM-1957/GRC or AM-1958(*)/GRC.	Set multimeter selector switch on T-893 (P)/GRC to PWR OUT and readjust AMP control while rotating COUPLING control to obtain higher DA-1891 GRC meter indication. Lock POWER OUT and COUPLING controls.	With AM-1957/GRC, DA-189/GRC meter should Indicate more than 12 watts. With AM-1968(*)/GRC, DA-189/GRC meter should Indicate more than 8 watts.	If minimum wattage is not obtained, check tubes V3, V2, and V1, in turn, and adjust associated resistor If necessary (para 5-13b). If tubes are replaced, repeat tuning procedures from step 38 through 46. Replace the amplifier-oscillator.
47	T-893 (P)/GRC	Set multimeter selector switch to REF PWR and PWR OUT and note multimeter indications. Set multimeter selector switch to PWR OUT.	PWR OUT indication should be no less than 4 times greater than REF PWR indication Multimeter indication should be no less than 20, in the HI and LO-band, except for channels 1 thru 20 in the LO-band where the indication should be no less than 16. LOW POWER indicator should be extinguished.	Substitute cable between T-893(P)/GRC and DA-189/GRC. Check amplifier-Oscillator tubes V1, V2, and V3 and adjust associated resistor if necessary

EQUIPMENT PERFORMANCE

Step	Unit	Action	Normal indication	Corrective measures
			indication should be no less than 16. LOW POWER indicator should be extinguished.	para 5-13b). If tubes are replaced, repeat tuning procedure from step 38 through step 47. Higher maintenance category repair required.
48	T-893(P)/GRC	Set multimeter selector switch to AFC LEV and adjust AFC LEVEL control for peak indication on multimeter.	Peak indication of more than 10 is obtained on multimeter and AFC meter indicates in center.	Check voltage supplied to afc assembly 2A4 (para 5-13e). Check tubes V6, V7, and V1 through V4 in afc assembly 2A4.
49	T-893(P)/GRC	Adjust AFC TUNE control slightly for peak indication on multimeter.	Peak indication is obtained on multimeter.	
50	T-893(P)/GRC	Set AFC TUNE-ODD-EVEN switch to ODD if selected channel is odd-numbered, or to EVEN if selected channel is even numbered. Rotate AFC CORRECTION control 30° to the right from its original setting. <i>Note.</i> Due to the time delay in afc circuit, wait until AFC meter indication has returned to its original indication before proceeding.	AFC meter indication moves off center then slowly returns to center; simultaneously, AFC CORRECTION control returns to original setting.	Check tubes V8 and V9 of assembly 2A4
51	T-893(P)/GRC	Rotate AFC CORRECTION control 30° to the left from its original setting.	Same as step 50.	Same as step 50. Adjust R42 on afc assembly to center AFC meter indication.
52	T-893(P)/GRC	Set multimeter selector switch to PWR OUT. Adjust POWER OUT control to reduce DA-189/GRC indication as follows: With AM-1957/GRC, reduce power to 11 watts; with AM-1958 (*)/GRC, reduce power to 5 watts. Adjust ALARM ADJ control until LOW POWER indicator lights and buzzer sounds. Depress BUZZ OFF push-button to silence buzzer. Readjust POWER OUT control to obtain original maximum indication on DA-189/GRC.	LOW POWER indicator lights and buzzer sounds. LOW POWER indicator extinguishes and buzzer sounds.	Replace indicator lamp. Check V1 on T-893(P)/GRC main frame.

EQUIPMENT PERFORMANCE

Step	Unit	Action	Normal indication	Corrective measures
53	R-1148(P)/GRC or R-1333(*) (P)/GRC	Set AC POWER switch to ON. Allow 5-minute warm-up.	AC POWER indicator lights. INCOMING CALL lamp lights momentarily. RING buzzer sounds momentarily. Blower motor operates.	Check silicon rectifiers on bottom of receiver for blistering or discoloration. If rectifiers are blistered or discolored, or show any signs of malfunction, higher category of maintenance is required.
54	R-1148(P)/GRC or R-1333(*) (P)/GRC	Set multimeter selector to TEST TONE CAL. Set TEST TONE switch to ON and adjust TEST TONE control for indication in green area of receiver multimeter.	Multimeter indicates in green area of meter scale.	Check V2 in signaling unit 3A6.
55	T-893(P)/GRC	Set multimeter selector switch to 1 KC MOD.	Multimeter indicates in green area of meter scale.	Check V1, V2, and V4 on 2A3. Check V5 on afc assembly 2A4. Check all tubes in modulator 2A5.
56	AM-1955(*)/GRC or AM-1956(*)/GRC	Set multimeter selector switch on R-1148(P)/GRC or R-1331(*) (P)/GRC to OSC and adjust OSCILLATOR control for peak indication on multimeter.	Peak indication is obtained on multimeter.	Check WAVEMETER control for correct setting. Check diode CR2 in wave-meter.
57	R-1148(P)/GRC. (Omit this step when using AM-1955A/GRC or AM-1956A/GRC.)	Set multimeter selector switch to AFC LEV. or more. Tune AFC LEVEL control for peak indication on multimeter.	Multimeter indicates 10 or more.	Check V1 through V7 on afc assembly 3A4.
58	R-1148(P)/GRC. (Omit this step when using AM-1955A/GRC or AM-1956A/GRC.)	Adjust AFC TUNE control for peak indication on multimeter.	Peak is indicated on multimeter.	
59	R-1148(P)/GRC (Omit this step when using AM-1955A/GRC or AM-1956A/GRC.)	Set AFC TUNE-ODD-EVEN switch to ODD if receiver channel is odd-numbered, or to EVEN if receiver channel is even-numbered. Rotate AFC correction control on AM-1955/GRC or AM-1956/GRC until AFC meter indicates ± 40 . After normal indication, repeat in the other direction.	AFC meter needle moves back toward center and stops near center. AFC correction control on AM-1955/GRC or AM-1956/GRC moves away from center position and then returns to original setting.	Adjust R42 on afc assembly 3A4 to center AFC meter needle. Check V8 and V9 on AFC assembly 3A4. If V8 is replaced, adjust R42 as required

EQUIPMENT PERFORMANCE

Step	Unit	Action	Normal indication	Corrective measures
60	AM-1955(*)/ GRC or AM-1956(*)/GRC.	Set multimeter selector switch on R-1148-(P)/GRC or R-1331(P)/GRC to OSC. Adjust WAVEMETER control for peak indication on multimeter.	Peak is indicated on multimeter WAVEMETER dial indicates within 2 dial divisions of indication listed on WAVEMETER CHART for desired receiver channel.	Repeat steps 56 through 60. If Indications are still abnormal, higher category of maintenance is required.
61	R-1148(P)/GRC or R-1331(*) (P)/ GRC	Press push-to-talk button on Handset H-156/U and speak into microphone.	Side tone is heard in H-156/U receiver.	Check Handset H-156/U and replace if required.
62	R-1148(P)/GRC or R-1331(*) (P)/GRC.	Press RING push-button and listen for side tone on Handset H-156/U.	1,600-cycle side tone is heard In Handset H-156/U.	Check V1 on signaling unit 3A6.
63	R-1148(P)/GRC or R-1331(*) (P)/GRC	Set multimeter selector switch to REC SIGNAL.		
64	AM-1955(*)/GRC or AM-1956(*)/GRC	Adjust REC SIG-1 for maximum indication on receiver multimeter.	Multimeter indicates peak or off scale.	
65	AM-1957/GRC or AM-1958(*)/GRC	Adjust REC SIG-2 control for maximum indication on receiver multimeter.	Multimeter indicates peak or off scale.	Substitute CG-718B/U between transmitter amplifier-oscillator and receiver amplifier-converter (fig. 6-3). Check crystal mixer CR1 and tube V1(para 5-13e). Note. If V1 is defective and replaced, substitute more than one V1 type tube. Do not discard tubes that are unsatisfactory; they are useful as replacements in another amplifier-converter. Check V1, V2, and V3 in first IF assembly 3A1/3A2A1. Check V1 through V6, V10, and V11 in second IF assembly 3A5. If V10 is defective, realignment of circuits in 3A5 is required at higher maintenance category.
66	R-1148(P)/GRC with AM-1955A/GRC or AM-1955B/GRC or AM-1956A/GRC or AM-1956 B/GRC.	Connect a jumper between test jacks J5 J7 of second if assembly 3A5 (fig. 5-9). Adjust OSCILLATOR control on AM-1955/ GRC or AM-1956A/ GRC for peak indication on multimeter. Remove Jumper.	Multimeter indicates peak.	
67	R-1331(*) (P)/GRC with AM-1955A/GRC or AM-1955B/ GRC, AM-1966A/GRC or AM-1956B/GRC.		Multimeter indicates peak.	

EQUIPMENT PERFORMANCE

Step	Unit	Action	Normal indication	Corrective measures
68	AM-1955(*)/GRC or AM-1956 (*)/ GRC.	Detune REC SIG-1 control for minimum indication on multimeter.	Multimeter indicates minimum level.	
69	R-1148(P)/GRC or R-1331(*) (P) / GRC.	Rotate SQUELCH INCR SENS control counter clockwise until squelch alarms operate.	NO SIGNAL Indicator lights and buzzer sounds. Depress SQUELCH BUZZER OFF push-button.	Check V12 on second IF assembly 3A5. If buzzer sounds but Indicator does not light, change indicator lamp.
70	AM-1955(*)/GRC or AM-1956(*)/ GRC.	Readjust REC SIG-1 control for maximum indication on multimeter	NO SIGNAL Indicator extinguishes and buzzer sounds. Depress SQUELCH BUZZER OFF push-button.	
71	Fdm multiplex equipment.	<i>For 4-channel fdm operation only</i>		
		Connect spiral -4 cable from multiplex equipment to RCVR OUT terminals (fig. 6-3.) Have multiplex terminal transmit 1- kc test tone at 0 dbm.		
72	T-893(P)/GRC	Set multimeter selector switch to 1 KC IN and adjust FDM INPUT LEVELS control for indication within green area of multimeter scale.	Multimeter indicates in green area of meter scale.	Check V4 in baseband assembly 2A3.
73	T-893(P)/GRC	Set multimeter selector switch 1 KC MOD.	Multimeter indicates in green area of meter scale.	Check V1 and V2 on baseband assembly 2A3. Check V5 on afc assembly 2A4. Check all tubes on modulator assembly 2A5.
74	R-1148(P)/GRC or P- 1331(*) (P)/GRC.	Set multimeter selector switch to 1 KC OUT and adjust FDM OUTPUT LEVEL control for Indication within green area of multimeter scale.	Multimeter indicates green area of meter scale.	Check V7, V8, and V9 In second IF assembly 3A5. Check tubes V5, V6, and V9 in baseband assembly 3A3. If meter indication obtained is not In green area, replace V9 until requirement is met. Do not discard unsatisfactory tubes; they are useful in other circuits.

EQUIPMENT PERFORMANCE

Step	Unit	Action	Normal indication	Corrective measures
75	R-1148(P)/GRC or R-1331 (*) (P)/GRC	Set multimeter selector switch to ORDERWIRE. <i>For 12/24 fdm channel operation only</i>	Multimeter indicates in green area of meter scale.	Check V7 and V8 in baseband assembly 3A3.
76	Fdm multiplex equipment	Connect spiral-4 cable from multiplex equipment to RCVR OUT terminals (fig. 6-3). Have multiplex terminal transmit 1-kc test tone at 0 dbm.		
77	T-893(P)/GRC	Set multimeter selector switch to 1 KC IN and adjust FDM INPUT LEVELS control for indication within green area of multimeter scale.	Multimeter indicates in green area of meter scale.	Check V4 in baseband assembly 2A3.
78	T-893 (P) /GRC	Set multimeter selector switch to 1 KC MOD and 68 KC MOD.	Multimeter indicates in green area of meter scale.	Check V1 and V2 on baseband assembly 2A3. Check V5 on afc assembly 2A4. Check all tubes on modulator assembly 2A5
79	R-1148 (P) /GRC or R-1331(*) (P)/GRC .	Set multimeter switch to 1 KC OUT and 68 KC OUT and adjust FDM OUTPUT LEVEL control for indication within green area of multimeter scale.	Multimeter indicates in green area of meter scale.	Check V7, V8, and V9 in second IF assembly 3A5. Check tubes V5, V6, and V9 in baseband assembly 3A3. If meter indication obtained is not in green area, replace V9 until requirement is met. Do not discard unsatisfactory tubes; they are useful in other circuits.
80	R-1148(P)/GRC or R-1331 (*) (P)/GRC	Set multimeter selector switch to ORDERWIRE.	Multimeter indicates in green area of meter scale.	Check V7 and V8 in baseband assembly 3A3. If necessary, replace V8 until meter indicates in green area. Do not discard unsatisfactory tubes; they are useful in other circuits.
81	Transmit and receive pcm equipment	<i>For Pcm channel operation only</i> Connect three cables to PCM IN, PCM OUT and PCM (order wire) (fig. 6-3). The pcm terminal should make required adjustments of its equipment.	Required indications are obtained.	Perform applicable corrective measures at pcm terminal.
82	T-893(P)/GRC	Set multimeter selector switch to PCM IN and adjust PCM INPUT LEVELS for multimeter indication in green area.	<i>Multimeter indicates in green area.</i>	Check connections of pcm transmit cable at PCM IN on transmitter and at pcm terminal. Check V1, V2, and V3 in baseband assembly 2A3.

EQUIPMENT PERFORMANCE

Step	Unit	Action	Normal indication	Corrective measures
83	R-1148(P)/GRC or R-1331(*) (P) /GRC	Set multimeter selector switch to PCM OUT. Adjust PCM INPUT LEVELS control on the transmitter for indication in green area on receiver multimeter.	Receiver multimeter indicates In green area.	Check V6, V7, V8, V9, and V12 in second IF assembly 3A5. Check V1, V2, and V3 in baseband assembly 3A3. <i>Proceed to step 84.</i>
84	Pcm receive terminal	The pcm terminal should make required adjustments of the received signal.	Required indications are obtained.	Check connections of pcm receive cable at PCM OUT on receiver and at pcm terminal. Perform required corrective measures at pcm terminal.
85	R-1148(P)/GRC or R-1331(*) (P) /GRC .			If required indications are not obtained at pcm terminal check V4 in baseband assembly 3A3. Do not discard unsatisfactory tubes If tube replacement results in meter indications consistently in the same meter area, refer receiver to higher maintenance services for adjustment of R23 in assembly 3A3.
86	R-1148(P)/GRC or R-1331(*) (P) /GRC.	Set multimeter selector switch to TEST TONE CAL and TEST TONE switch to ON. Adjust TEST TONE control for indication in green area of multimeter scale (approximately 0 dbm).	Multimeter indicates in green area.	Check V2 in signaling unit 3A6.
87	T-893 (P)/GRC	Set multimeter selector switch to 1 KC MOD.	Multimeter indicates in green area.	Check V5 (metering tube) in afc assembly 2A4.
88	Pcm receive terminal.	Adjust level of test tone	Required indications are obtained.	Perform required corrective measures.
89	R-1148 (P) /GRC or R-1331 (*) (P)/GRC	Set multimeter selector switch to ORDERWIRE.	Multimeter indicates in green area.	Check connection of, pcm order wire cable at PCM on receiver and at pcm terminal. Check V7 and V8 in baseband assembly 3A3. Is necessary, replace V8 until meter indicates in green area. Do not discard unsatisfactory tubes; they are useful in other circuits.
90	R-1148(P)/GRC or R-1331 (*) (P)/	<i>Operate RING switch and listen on handset.</i>	a. 1,600-cps ringing tone should be heard. b. CALL indicator should light and buzzer should sound	a. Check V2 in signaling unit 3A6. b. Check V1 in signaling unit 3A6. Check CALL Indicator lamp If buzzer sounds but lamp does not light
91	R-1148(P)/GRC or R-1331(*) (P)/GRC	Talk into handset microphone.	Sidetone should be heard.	<i>Replace handset.</i>

5-12. Trouble Sectionalizing Chart

When any of the major components contain the symptoms listed in the chart below, the major component is defective. Refer to paragraph 5-13 for repair and adjustment procedures.

Component at fault	Symptom																										
CN-514/GRC -----	POWER ON-OFF circuit breaker trips to OFF. Front panel indicators remain off. REGULATED OUTPUT VOLTAGE meter does not indicate 115 volts.																										
PP 2054(*)/GRC -----	AC POWER circuit breaker trips to OFF or front panel indicators remain off.																										
T-893(P)/GRC -----	LOW POWER Indicator lights and alarm buzzer sounds. AFC CORRECTION control does not return to midrange when control is turned Multimeter Indication not within limits listed below: <table border="0" style="width: 100%; border-collapse: collapse;"> <thead> <tr> <th style="text-align: left; border-bottom: 1px solid black;"><i>Multimeter selector switch setting</i></th> <th style="text-align: left; border-bottom: 1px solid black;"><i>Multimeter indication</i></th> </tr> </thead> <tbody> <tr> <td>OSC (high band only)</td> <td>At least 10.</td> </tr> <tr> <td>MAIN TUNE</td> <td>Same as above.</td> </tr> <tr> <td>MIXER</td> <td>Same as above.</td> </tr> <tr> <td>AMP</td> <td>Same as above.</td> </tr> <tr> <td>OUT FREQ</td> <td>HI-BAND 20, Lo-BAND 20 (except channels 1 through 20 at least 16).</td> </tr> <tr> <td>PWR OUT.....</td> <td>Same as above.</td> </tr> <tr> <td>AFC LEV.....</td> <td>Same as above.</td> </tr> <tr> <td>1 KC IN</td> <td>Within green area of meter scale (fdm).</td> </tr> <tr> <td>68 KC IN</td> <td>Same as above.</td> </tr> <tr> <td>1 KC MOD</td> <td>Same as above.^a</td> </tr> <tr> <td>68 KC MOD.....</td> <td>Same as above.</td> </tr> <tr> <td>PCM IN</td> <td>Actual indication obtained is recorded when distant receiver states he has indication in green area for PCM OUT (para 3-14e).</td> </tr> </tbody> </table>	<i>Multimeter selector switch setting</i>	<i>Multimeter indication</i>	OSC (high band only)	At least 10.	MAIN TUNE	Same as above.	MIXER	Same as above.	AMP	Same as above.	OUT FREQ	HI-BAND 20, Lo-BAND 20 (except channels 1 through 20 at least 16).	PWR OUT.....	Same as above.	AFC LEV.....	Same as above.	1 KC IN	Within green area of meter scale (fdm).	68 KC IN	Same as above.	1 KC MOD	Same as above. ^a	68 KC MOD.....	Same as above.	PCM IN	Actual indication obtained is recorded when distant receiver states he has indication in green area for PCM OUT (para 3-14e).
<i>Multimeter selector switch setting</i>	<i>Multimeter indication</i>																										
OSC (high band only)	At least 10.																										
MAIN TUNE	Same as above.																										
MIXER	Same as above.																										
AMP	Same as above.																										
OUT FREQ	HI-BAND 20, Lo-BAND 20 (except channels 1 through 20 at least 16).																										
PWR OUT.....	Same as above.																										
AFC LEV.....	Same as above.																										
1 KC IN	Within green area of meter scale (fdm).																										
68 KC IN	Same as above.																										
1 KC MOD	Same as above. ^a																										
68 KC MOD.....	Same as above.																										
PCM IN	Actual indication obtained is recorded when distant receiver states he has indication in green area for PCM OUT (para 3-14e).																										
R-1148(P)/GRC or R-1331 (*)/GRC	NO SIGNAL lamp lights and alarm buzzer sounds. AFC CORRECTION control (on AM-1956/GRC or AM-1956/GRC) does not return to midrange when control is turned (R-1148(P)/GRC ONLY). Multimeter indication not within limits listed below <table border="0" style="width: 100%; border-collapse: collapse;"> <thead> <tr> <th style="text-align: left; border-bottom: 1px solid black;"><i>Multimeter selector switch setting</i></th> <th style="text-align: left; border-bottom: 1px solid black;"><i>Multimeter indication</i></th> </tr> </thead> <tbody> <tr> <td>OSC.....</td> <td>At least 10.</td> </tr> <tr> <td>REC SIGNAL (Acceptable signal is required at receiver input for this test.)</td> <td>Same as above for fdm operation; and at least 18 when pcm is connected at distant transmitter.</td> </tr> <tr> <td>AFC LEVEL (Applicable when checking R-1148(P)GRC with AM-1955/GRC or AM-1956/GRC.)</td> <td>Same as above.</td> </tr> <tr> <td>ORDER WIRE.....</td> <td>Green area.^a</td> </tr> <tr> <td>1 KC OUT.....</td> <td>Same as above.</td> </tr> <tr> <td>68 KC OUT.....</td> <td>Same as above.</td> </tr> <tr> <td>PCM OUT.....</td> <td>Same as above.^a</td> </tr> </tbody> </table>	<i>Multimeter selector switch setting</i>	<i>Multimeter indication</i>	OSC.....	At least 10.	REC SIGNAL (Acceptable signal is required at receiver input for this test.)	Same as above for fdm operation; and at least 18 when pcm is connected at distant transmitter.	AFC LEVEL (Applicable when checking R-1148(P)GRC with AM-1955/GRC or AM-1956/GRC.)	Same as above.	ORDER WIRE.....	Green area. ^a	1 KC OUT.....	Same as above.	68 KC OUT.....	Same as above.	PCM OUT.....	Same as above. ^a										
<i>Multimeter selector switch setting</i>	<i>Multimeter indication</i>																										
OSC.....	At least 10.																										
REC SIGNAL (Acceptable signal is required at receiver input for this test.)	Same as above for fdm operation; and at least 18 when pcm is connected at distant transmitter.																										
AFC LEVEL (Applicable when checking R-1148(P)GRC with AM-1955/GRC or AM-1956/GRC.)	Same as above.																										
ORDER WIRE.....	Green area. ^a																										
1 KC OUT.....	Same as above.																										
68 KC OUT.....	Same as above.																										
PCM OUT.....	Same as above. ^a																										

^a For pcm operation, indication obtained depends on adjustments made during pcm system lineup (para 3 14d and e).

5-13. Repairs and Adjustments

These procedures are designed to aid the organizational repairman in determining when adjustments or repairs are required. If the suggested adjustments or repairs do not restore normal operation, or normal indication is not obtained after test, repair, or adjustment, higher category of maintenance is required.

a. Power Supply PP-2054(*)/GRC. Set the multimeter selector switch on the T-893(P)/GRC to TEST and perform the tests below; use the maintenance test leads provided with the radio set to make the test jack connections.

NOTES

1. T-893(P)/G R C test jacks are shown in figure 6-4; PP-2054(*) GRC test jacks are shown in figure 6-5.
2. On multimeters that do not have green and orange areas, indications between 22 and 28 correspond to the green area; indications between 17 and 33 correspond to the orange area.

Test jacks connections		Normal indication on T-893(P)/GRC multimeter	PP-2054(*)/GRC procedure
From T-893(p)/GRC	To PP-2054(*)/GRC		
J7----- (chassis) J6-----	J10----- (chassis) J3 (800 vdc.)	Between orange marks-----	Check V1 through V4. If silicon rectifiers are discolored, higher category of maintenance is required. If V4 is replaced, readjust R45 (below).
J7----- J6-----	J10----- J4 (645 vdc).	Between orange marks.	
J7----- J6-----	J10----- J5 (645 vdc).	Between orange marks.	
J7----- J6-----	J10----- J6 (360 vdc).	Between orange marks.	
J7----- J5-----	J10----- J7 (250 vdc).	In green area-----	Adjust R45 to obtain indication within green area.
J7----- J6-----	J10----- J94 (105 vdc).	Between orange marks-----	Check v5.
J7----- J6-----	J10----- J8 (150 vdc).	Between orange marks.	

b. Transmitter, Radio T -893(P)/GRC, Current Regulator Assembly 2A6 Adjustments for Amplifier-Oscillator Tubes. Assembly 2A6 circuits are adjusted by current regulator potentiometers R14, R15, and R16 (fig. 6-4), which control the voltage applied to the 2A6. cathodes of V1, V2, and V3, respectively, in the amplifier-oscillator.

- (1) The adjustment of the respective potentiometers must be performed for each of the following conditions:
 - (a) When a tube in the amplifier oscillator is changed, the associated potentiometer is adjusted.
 - (b) All potentiometers are tested and adjusted, if necessary, when the following items are changed:
 1. The amplifier-oscillator.
 2. The current regulator assembly
 3. Tube V4 in PP-2054(*)/GRC.

NOTE

The current regulator circuit test jacks J16, J17, and J18 on the transmitter main frame (fig. 6-4) are used to connect the respective current regulator circuit to multimeter circuit test jacks J5 and J7.

TM 11-5820 461-12

(2) To make the tests and adjustments, maintenance test leads supplied with the set the transmitter multimeter selector radio set. Replace the snap-on cover over con-switch to TEST and make the following test controls R14, R15, and R16 after performing the jack connections and adjustments. Use the required adjustments (pare 1-14f; fig. 6-4).

Stage being checked	Test lead connections (main frame)	Normal meter indication	Procedure
250-volt circuit. Perform this test and adjustment before performing following tests. Oscillator V1 Mixer V2 Amplifier V3	J7 on T-893(P)GRC to J10 on PP-2054(*)/GRC.; and J5 on T-893(P)/GRC to J7 on PP-2054/GRC. J7 to J15 and J5 to J16 J7 to J15 and J5 to J17 J7 to J15 and J5 to J18	Green area Green area b,c Green area b Green area b	Adjust R45 on PP-2054(*)/GRC. Adjust R14. Check V1.a Adjust R15. Check V2. a Adjust R16. Check V3. a

- a Tighten locknuts on control after adjustment. If replace tube, readjust the control.
- b Do not adjust control for indication higher than green area. To do so, greatly reduces tube life.
- c If unable to reach green area, adjust the control to obtain an indication at least at the left orange area

c. Modulator Assembly 2A5 and Afc Assembly 2A4. The following checks are used to check the voltages at various points on transmitter assemblies 2A4 and 2A5. To make the tests, proceed as follows:

(1) Turn off power to the transmitter by setting PP-2054(*)/GRC OPERATE-STANDBY switch to STANDBY, and the AC POWER circuit breaker to OFF.

(2) Set a chair or box (equivalent in height to transmitter case) in front of the T -8 93(P)/GRC. Loosen the bolts holding the transmitter in its carrying case. Remove all cable connections from the transmitter front panel. Pull out the transmitter chassis from its carrying case and set the chassis on the chair or box In front of the stack of the radio. (This procedure is required in order to gain access to the test jacks while power is applied to the transmitter.)

(3) Reconnect the CX -4 558/GRC to the transmitter TO PWR SUP receptacle (fig. 6 3). Connect DA-189/GRC through CG-718B/U to the transmitter TO ANT receptacle.

NOTE

The connections of CX 4557/GRC and CG-718B/U from the receiver are not required.

(4) On PP-2054(*)/GRC, set AC POWER switch to ON and OPERATE-STANDBY switch to STANDBY. After about 2 minutes, set OPERATE-STANDBY switch to OPERATE.

(5) If the last step of the following chart (for crystal diodes CR11 and CR12 on 2A4) is to be performed, tune the transmitter to an assigned frequency.

(6) Set the transmitter multimeter selector switch to TEST, and make the indicated test jack connections; use the maintenance test leads supplied with the radio set.

NOTE

Multimeter circuit test jacks J6 and J7 and the test jacks on the assemblies are shown in figure 6-4.

Test lead connections

Stage being checked	Transmitter mainframe	Assembly	Normal indication	Procedure
Modulator assembly 2A5	J7 (chassis)----- J6-----	J9 on 2A5----- J7 on 2A5	Between orange marks (360 volts dc.)	Check PP-2054(*)/GRC (a above) for 360 volts dc. Check tube V5 on 2A5.
	J7----- J6-----	J9 on 2A5----- J6 on 2A5	In green area (250 volts dc.)	Check PP-2054(*)/GRC (a above) for 250.

Stage being checked	Test lead connections		Normal indication	Procedure
	Transmitter main frame	Assembly		
	J7----- J6-----	J9 on 2A5----- J4 on 2A5.	In green area (150 volts dc.)	volts dc. Check tubes V3 and V4 on 2A5. Check tubes V1 and V2 on 2A5.
Afc assembly 2A4-----	J7 (chassis)----- J6-----	J10 on 2A4----- J12 on 2A4	Between orange marks (150 volts dc.)	Check PP-2054(*)/GRC (a above) for 150 volts dc.
	J7----- J6-----	J10 on 2A4----- J5 on 2A4	Between orange marks (250 volts dc.)	Check PP-2054(*)/GRC (a above) for 250 volts dc.
	J7----- J6-----	J4 on 2A4----- J10 on 2A4	From slight deflection to off scale. The higher DA-189/GRC indication, the higher TEST indication ((5) above).	Check crystal diodes CR11 and CR12 on Z1 (para 5-15c). Check V7 on 2A4. (Tune transmitter before making test.)

d. Receiver, Radio R-1148(P)/CRC or R-1331(*) (P)/GRC Power Supplies. Set the receiver multimeter switch to TEST and make the following connections; use the maintenance test leads supplied with the radio set. Set the receiver AC POWER switch to ON.

Stage being checked	Test lead connections	Normal multimeter indication	Procedure
Receiver power supply.	J10 (chassis; fig. 5-10) to J12 (fig. 6-6); and J11 (150 vdc; fig. 5-10) to J14 (fig. 6-6).	Green area-----	Adjust R36. Check V1, V3, V4, and V5.
Receiver power supply.	J10 to J12; and J9 (250 vdc) to J14.	Green area-----	Adjust R18. Check V2.

e. Amplifier-Converter AM-1955(*)/GRC or AM-1956(*)/GRC. Set the receiver multimeter selector switch to TEST and make the following connections; use the maintenance test leads supplied with the radio set.

(1) To reach test jacks J3 and J4 on first IF assembly 3A1A1/3A2A1 (fig. 6-7 or 6 8), remove the amplifier-converter from the receiver. Use Extender, Module MX-6988/GRC-50(V) from Test Facilities Kit MK-715/GRC-50(V) to make the connection between the connectors of the amplifier-converter and the receiver.

(2) Set switches as follows for the tests in chart below:

(a) Set OSCILLATOR control to channel 200 for the AM-1955(*)/GRC and to channel 650 for the AM-1966(*)/GRC.

(b) Set the REC SIG-1 control to the highest channel on the dial.

(c) On R-1148(P)/GRC, only, set AFC TUNE-ODD-EVEN switch to TUNE and on the AM-1955,1GRC or AM-1956/ RC, set the AFC correction control to midrange.

Stage being checked	Test lead connections		Normal indication on multimeter	Procedure
	On receiver (fig. 6-6)	On assembly		
Crystal mixer CR1 and oscillator V1.	J12----- J13-----	J4 on 3A1A1/3A2A1 (fig. 6-7 Or 6-8) J3 on 3A1A1/3A2A1.	Between 5 and 50.	Check CR1 (fig 6-7 Or 6-8) (para 5-15c). Check tube V1 by substitution; turn power off before making substitution. Refer to paragraph 5-14e for tube V1 replacement procedure If indication IS obtained on AM-1955(*)/GRC, no further action is required. If Indication is obtained on AM-1956(*)/GRC, mechanical realignment of oscillator cavity is required at higher maintenance category

f. *Afc Assembly 3A4 (Used in R-1148(P)/ GRC Only).*

(1) Set switches as follows:

(a) Set OSCILLATOR control to channel 200 when AM-1955/GRC is used or to channel 650 when AM-1956/GRC is used.

(b) Set REC SIG-1 control to highest channel on the dial.

(c) Set AFC TUNE-ODD-EVEN to TUNE.

(d) Set AFC correction control to midrange.

(e) Set multimeter selector switch to

(2) Set maintenance test leads to make the following connections and test:

(a) Connect one test lead between J12 on the receiver and J10 on 3A4. Connect another test lead between J13 on the receiver and J12 (+150 volts dc) on 3A4.

(b) The multimeter should indicate between the orange marks.

(3) If the required meter indication is not obtained, check power supply tubes V4 and V5 in the receiver chassis (fig. 5-10).

5-14. Tube Replacement Procedures

When trouble occurs, check all cables, connections, and fuses before removing and testing any tubes. Attempt to isolate the trouble to a component or assembly. When tube failure is suspected, use the procedures contained in a through f below to gain access to the tubes.

a. T-898(P)/GRC. Loosen the screws that attach the T-893 (P) /GRC to the component case, and slide the component out of the case The plug-in assembly locations in the T-893 (P)/GRC are shown in figure 5-4. The locations of tubes in the plug-in assemblies of the T-893(P)/GRC are shown in figures 5-4 through 5-6 When the defective tube is replaced, slide the component back into the case and tighten the screws.

b. AM-1957/GRC or AM-1958(*)/GRC. Loosen the screws that attach the AM-1957/ GRC or AM-1958(*)/GRC to the T-893(P)/ GRC, and remove the AM-1957/GRC or AM-1958(*) /GRC from the T-893(P)/GRC. The locations of tubes in the AM-1957/GRC and the AM-1958(*)/GRC are shown in figures 6-9 and 6-10, respectively. Remove and replace the tubes as follows:

(1) Lift the spring-loaded cover up and back from the top of the tube. The cover will remain upright when placed back.

(2) Carefully remove the tube with the tube extractor by turning it slowly and exerting an upward pull.

(3) Carefully insert a new tube in the socket by gently pushing it downward.

(4) Place the spring-loaded cover gently on the top of the tube. Do not snap the cover back into position.

c. PP-2054(*)/GRC. Loosen the screws that attach the PP-2054(*)/GRC to the component case, and slide the component out of the case. The tube locations are shown in figure 6-5.

d. R-1148(P)/GRC or R-1881(*)/GRC. Loosen the screws that attach the R-1148(P)/GRC or R-1331(*)/GRC to the component case, and remove the component from the case. Loosen the screws that attach the access cover to the rear of the R-1148(P)/GRC or R-1331(*)/GRC, and remove the cover. The plug-in assembly locations in R-1148(P)/GRC or R-1331(*)/GRC are shown in figure 6-6. The location of tubes on the main frame of the R-1148(P)/GRC or R-1331(*)/GRC is shown in figure 5-10. The locations of tubes in plug-in assemblies are shown in figures 5-5, 5-7, and 5-9.

CAUTION

Do not replace tube V8, V10, or V11 in second IF assembly 3A5. Tube replacement requires realignment of the associated circuit at higher maintenance category.

e. AM-1955(*)/GRC or AM-1956(*)/GRC. Loosen the screws that attach the amplifier-converter to the receiver and remove the assembly from the receiver. The location of the AM-1955(*)/GRC tubes is shown in figure 6-7; those in the AM-1956(*)/GRC are shown in figure 6-8.

NOTE

Tube type 4037A is used in the amplifier-converters for V1. It replaces tube type 2C40A. The 4037A should not be used in the AM-1956/GRC unless MWO 11-5820-461-35/2 has been applied.

(1) Remove the amplifier-converter from the receiver.

(2) Remove the four screws that hold the cap-socket assembly in the rear of the V1 cavity. The screws are located on the corners of the cap.

NOTE

Do not remove the two screws on the raised cylindrical portion of the capsocket assembly.

(3) Lift the cap-socket assembly slowly and evenly; the tube is attached to it. If the tube remains in the cavity, carefully pull it straight out. Do not use sideward force on the tube.

CAUTION

Replace the cylindrical plastic bushing at the bottom of the cavity (if it has come out with the tube). If the bushing is left out, improper action results and the tube can damage the grid socket fingers.

(4) If the tube is broken, turn the equipment upside down and shake the broken glass out.

(5) Carefully insert the new tube into the cavity. Orient the base so that the locking pin or key on the base mates with the keyway in the ceramic socket.

(6) Check to see that the tube is fully and firmly seated in the tube socket.

(7) Carefully place the cap-socket assembly over the tube, press it down carefully, and tighten the four screws.

(8) To check the output of the tube, use the procedures in paragraph 5-13e. Then check for REC SIG operation of the receiver. Check several tubes to obtain proper REC SIG Indication. Do not discard tubes that fail to provide satisfactory REC SIG Indication; the unsatisfactory tubes can be used in other amplifier-converters.

f. CN-514/GRC. Loosen the screws that attach the CN-514/GRC to the component case, and slide the component out of the case. The tube locations are shown in figure 5-11.

5-15. Repairs

Replacement of tube V1, V2, or V3 in the amplifier-oscillator, replacement of the amplifier-oscillator, tube current regulator assembly 2A6, or tube V4 in PP-2054(*)/GRC will require adjustment of regulator resistors R14, R15, and R16. Refer to paragraph 5-13b for the procedures. Replacement procedure for plug-in assemblies is given in a below. Receiver lightning arresters protecting the fdm cable circuits are located at the input to baseband assembly 3A3 in the receiver (fig. 5-13). Procedures for their replacement are given in b below.

a. *Replacement of Plug-In Assemblies.* Remove and replace plug-in assemblies in the radio set as follows

- (1) Remove any interconnecting cables.
- (2) Loosen the mounting hardware.
- (3) Grasp the assembly handles and pull the assembly straight up from the chassis.
- (4) Insert the new assembly. Check to see that the assembly is seated evenly on the chassis.
- (5) Tighten the mounting hardware.
- (6) Replace all interconnecting cables. Be sure that the cables have been connected to the proper receptacle.

b. *Replacement of Lightning Arresters* (fig. 5-13).

- (1) Loosen the attaching screws on the front of the receiver and slide the chassis about 6 inches out of the component case.
- (2) Remove the front access plate on the light side of the receiver chassis and inspect the interior wiring for charred insulation, broken connections, etc. If damage is extensive, higher category of maintenance is required.
- (3) Unscrew the lightning arresters and remove them.
- (4) Insert the new lightning arresters (fig. 1-3 or 1-1.1). Check to see that they are seated correctly.
- (5) Replace the access plate and push the receiver chassis into the component case. Tighten the attaching screws on the front panel of the receiver.

c. *Replacement of Diodes.* To remove and replace a diode, unscrew the connector, pry out the diode from the receptacle, and insert the proper diode. Replace the connector and screw it tightly to the receptacle. The type and location of replaceable diodes are given in the following chart. The diodes listed are the preferred types.

Location		Figure	Designation	Type
Unit				
AM-1957/GRC and AM-1958(*)/GRC.		6-9 and 6-10.	CR1 and CR2. CR3 (wavemeter).	1N23WEa 1N21WEb
AM-1955/GRC and AM-1956(*)/GRC.		6-7 and 6-8.	CR1----- CR2 (wavemeter).	1N21WE 1N21WEb
T-893(P)/GRC (afc cavity Z1).		5-12-----	CR12-----	1N21WEc
R-1148(P)/ GRC (afc cavity Z1).		5-12-----	CR-111-----	1N21WEc
DA-189/GRC-----		1-14-----	CR1-----	1N23WE

- a. Type 1N23C is provided in some equipment and may be used.
- b. Type 1N21B is provided in some equipment and may be used.
- c. Type 1N21C is provided in some equipment and may be used.

d. *Equipment Modifications and Changes.* In addition to the equipment modifications specified by modification work orders (MWO's) (listed in DA Pam 310-7), the changes listed in (1) through (4) below are authorized and required to be performed on equipment in the hands of using organizations. These changes are designed to facilitate maintenance or improve the operation of the equipment. These changes are mandatory. The changes to the equipment given in (1), (2), and (3) below are authorized to be performed by organizational level maintenance facilities; the change given in (4) below is authorized to be performed by direct support (DS) maintenance facilities. The equipment changes are not reportable and require no documentation; however, local records should be maintained (at organizational and DS level) listing the equipment serial numbers against the equipment that has been changed. In this way, equipment that has been changed can be identified.

(1) PP-2054(*)/GRC. The following change of fuse and its panel marking applies to the PP-2064/GRC, not to the PP-2054A/GRC; the latter is provided with the proper 3-ampere fuse. The original 5-ampere fuse did not provide enough protection when there was an overload in the oscillator circuit of the amplifier-oscillator (AM-1957/GRC or AM-1958(*)JGRC), resulting in a burn-out of resistor R13 in the PP-2054/GRC.

- (a) Remove the 5-ampere HV fuse (fig. 3-4) and insert the 3-ampere, 125-volt, time-delay fuse (FSN 5920-131-9821).
- (b) Mark the panel with 3 AMP SLO-BLO in place of "5 AMP."

NOTE

This fuse is the same as the one used in LV 3 AMP holder.

(2) T-893 (P)/GRC. In the transmitter main frame, a snap-on cover is installed over the adjustment screws for current regulator controls R14, R15, and R16 (fig. 6-4). To install the snap-on cover (FSN 5820-055-5973), pull out the transmitter main frame and press the cover over the bracket holding the controls. Refer to paragraph 5-13b for procedures to adjust these controls, and for conditions under which the controls must be adjusted.

(3) Assembly 2A4 in T-893(P)/GRC and Assembly 3A4 in R-1148 (P)/GRC. In afc assembly 2A4/3A4, an insulator board must be inserted between terminal board E8 and the metal partition on which E8 is mounted (fig. 5-14) on those assemblies in which the boss (small hump in the metal) is not provided in the metal partition midway between the bosses for the E8 mounting screws. The purpose of the insulator board, or the boss in the metal partition, is to prevent resistors R28 and R33 from touching the metal partition when E8 warps, which would cause them to burn out. In afc assemblies issued with T-893(P)/GRC and R-1148 (P)/GRC on order No. 64027-PP -6 3 (RCA), and on later orders, the boss is provided in the partition behind E8. The assembly must be removed from the equipment and the terminal board and the metal partition investigated to determine if the insulator board must be requisitioned and installed.

(a) To install the insulator board (FSN 5970-935-4977), loosen mounting screws holding E8 to the center partition, and slide the insulator board behind E8 (fig. 5-3.1)

(b) Tighten the E8 mounting screws.

(4) AM-1958A/GRC. When the cover assembly for tube V3 in AM-1958A/GRC is lifted up, it snaps down again because there is not enough clearance between the cover and the frame (fig. 6-10). Instruction to cut the notch to provide the necessary clearance for the cover of V3 are provided in TM 11-5820-461-35 for direct support maintenance facilities.

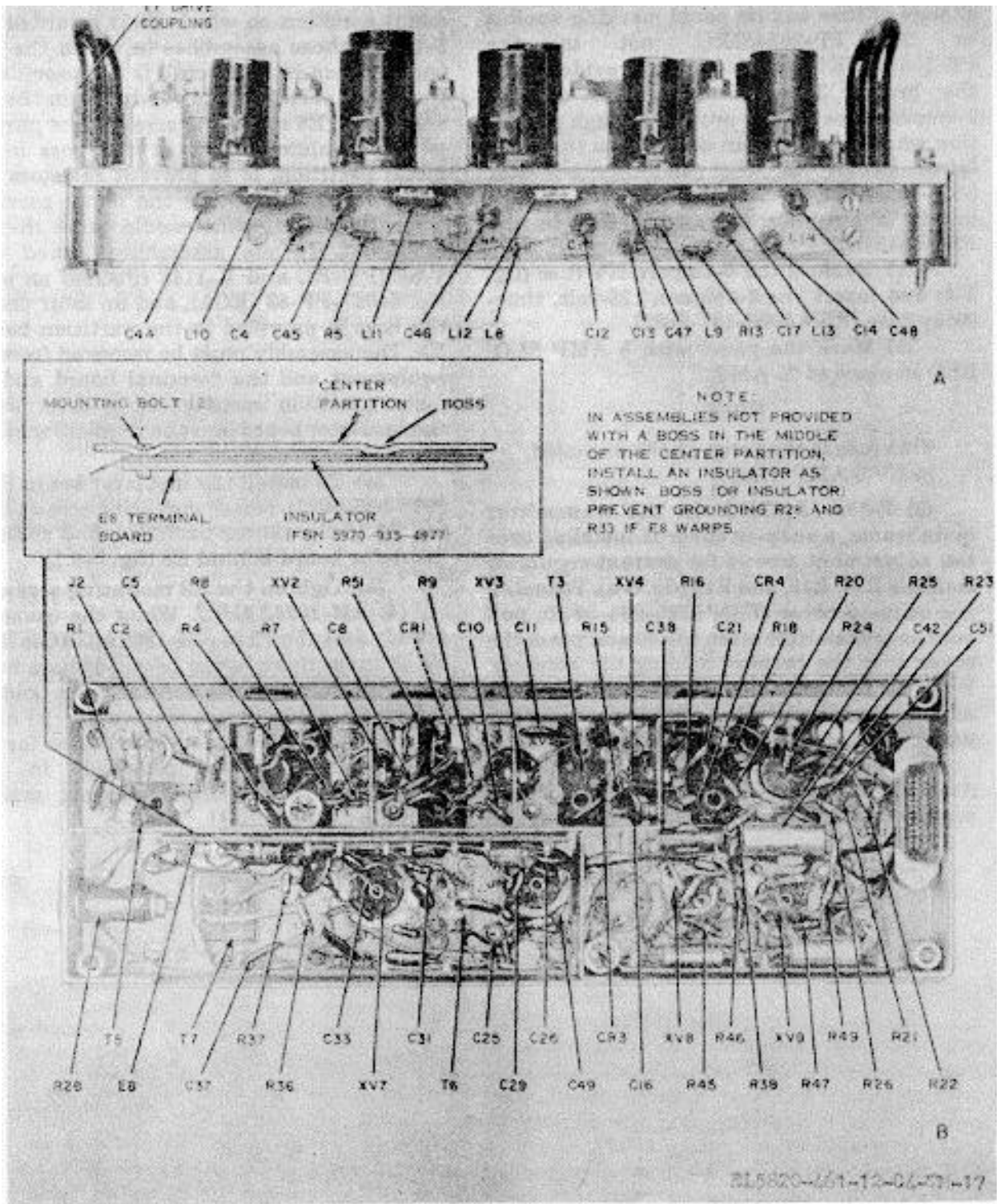

Figure 5-3.1. Afc assembly 2A4/3A4, side and bottom views, and details for installing insulator board behind terminal board E8.

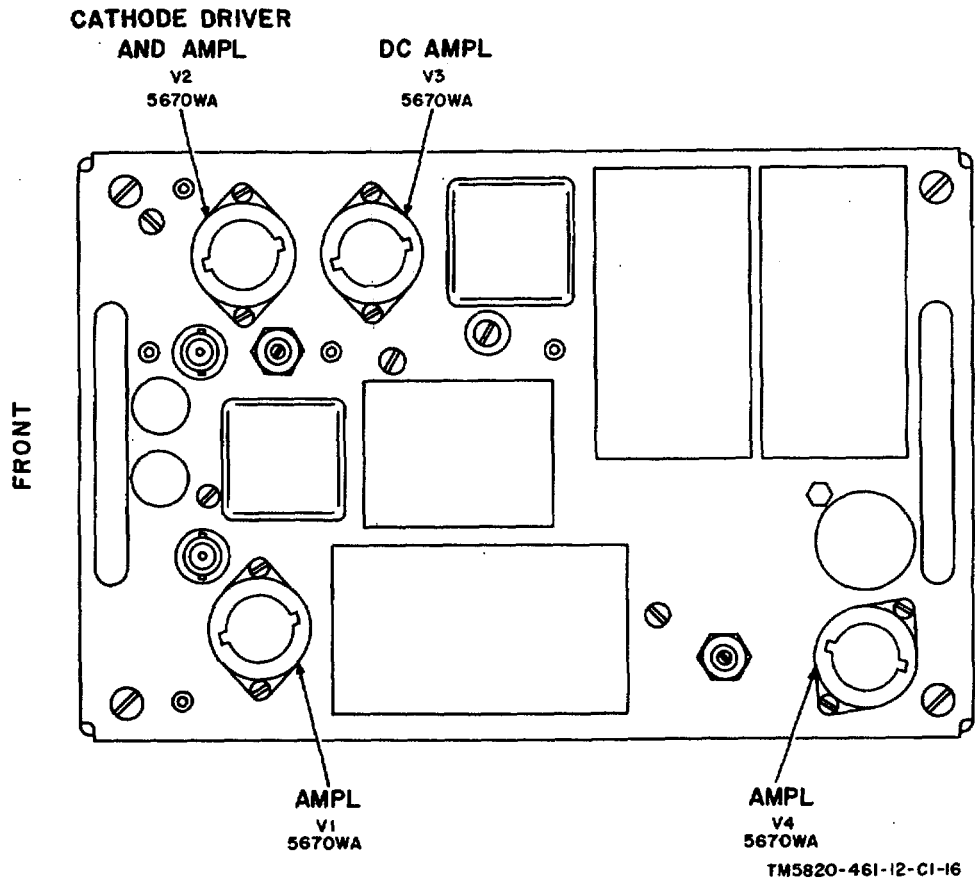

Figure 5-4. Baseband assembly 2A3 (part of T-893(P)/GRC), tube locations.

AGO 10032A

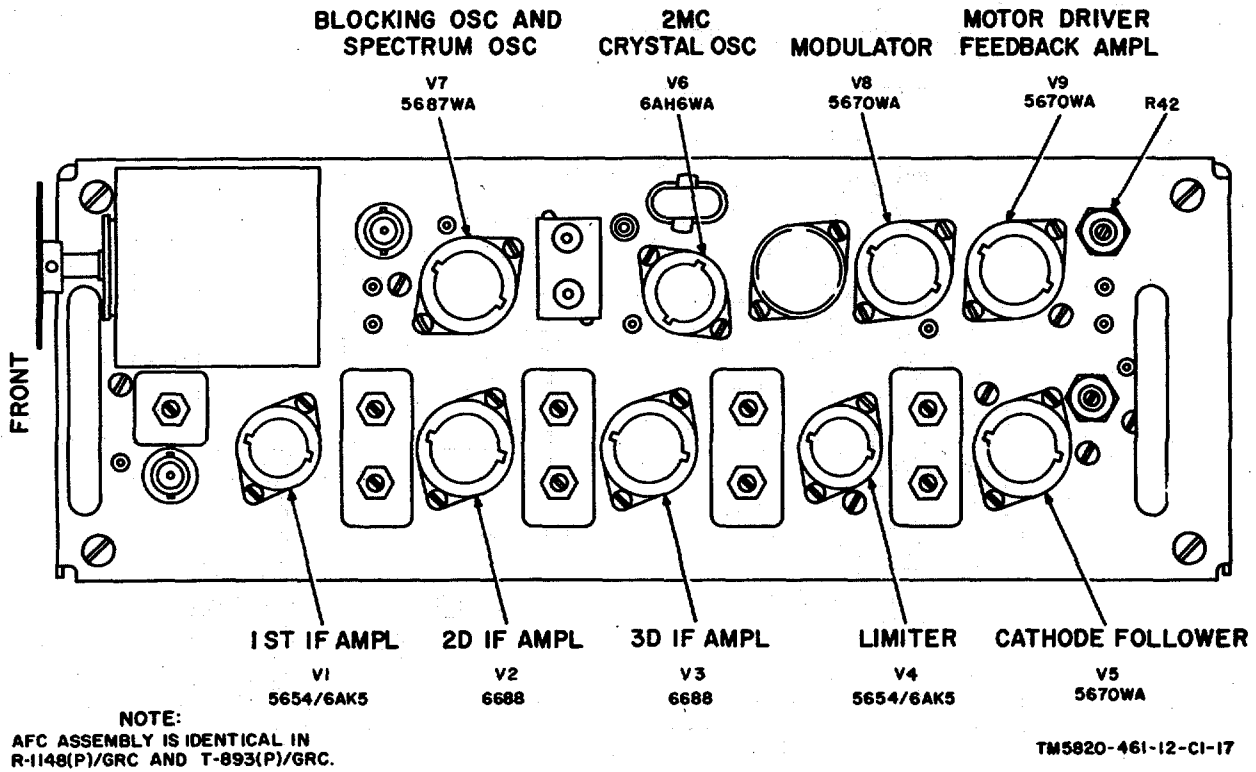

Figure 5-5. Afc assembly 2A4/3A4 (part of T-893(P)/GRC and R-1148(P)/GRC), tube locations.

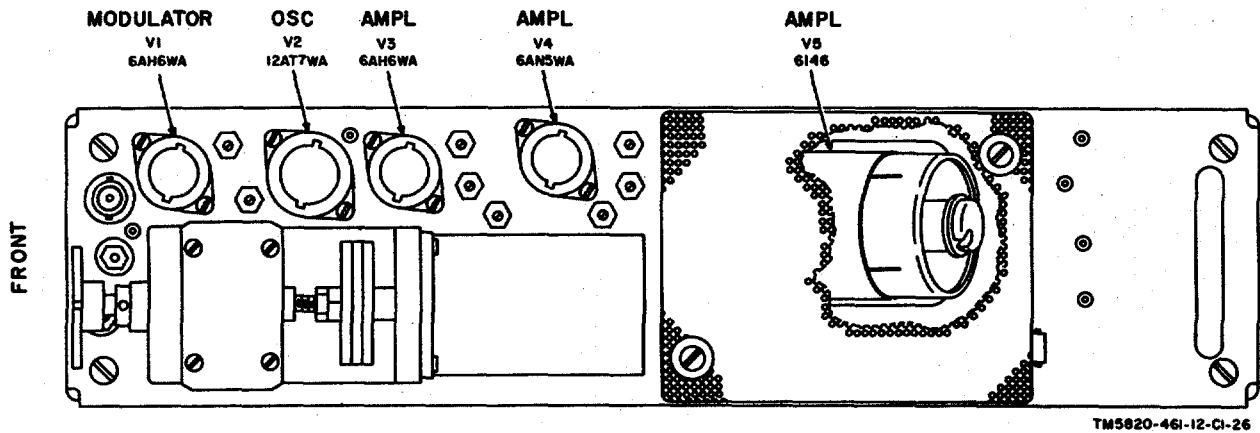

Figure 5-6. Modulator assembly 2A5 (part of T-893(P)/GRC), tube locations.

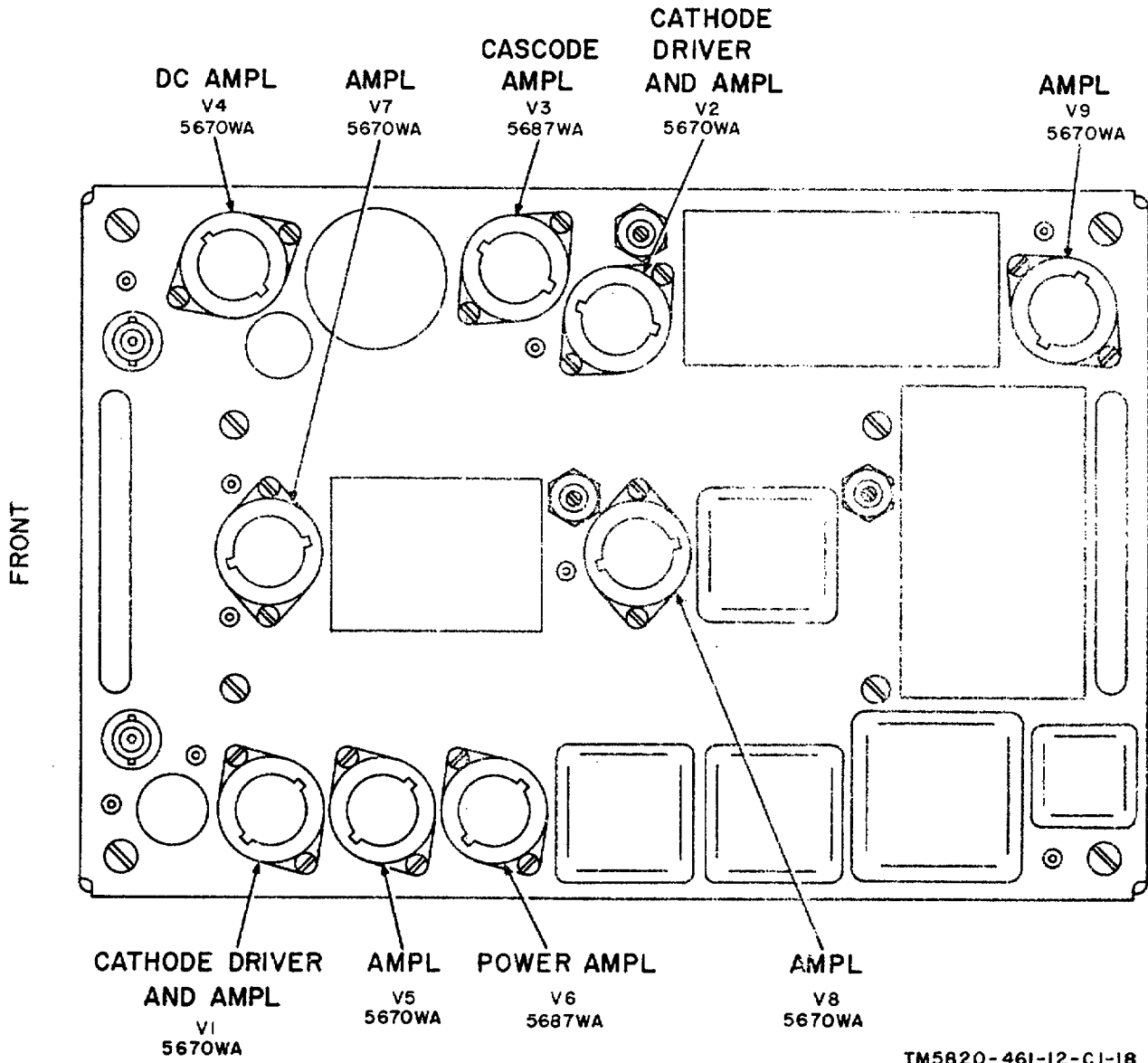

Figure 5-7. Baseband assembly 3A3 (part of R-1331(*) (P)/GRC or R-1148(P)/GRC), tube locations.

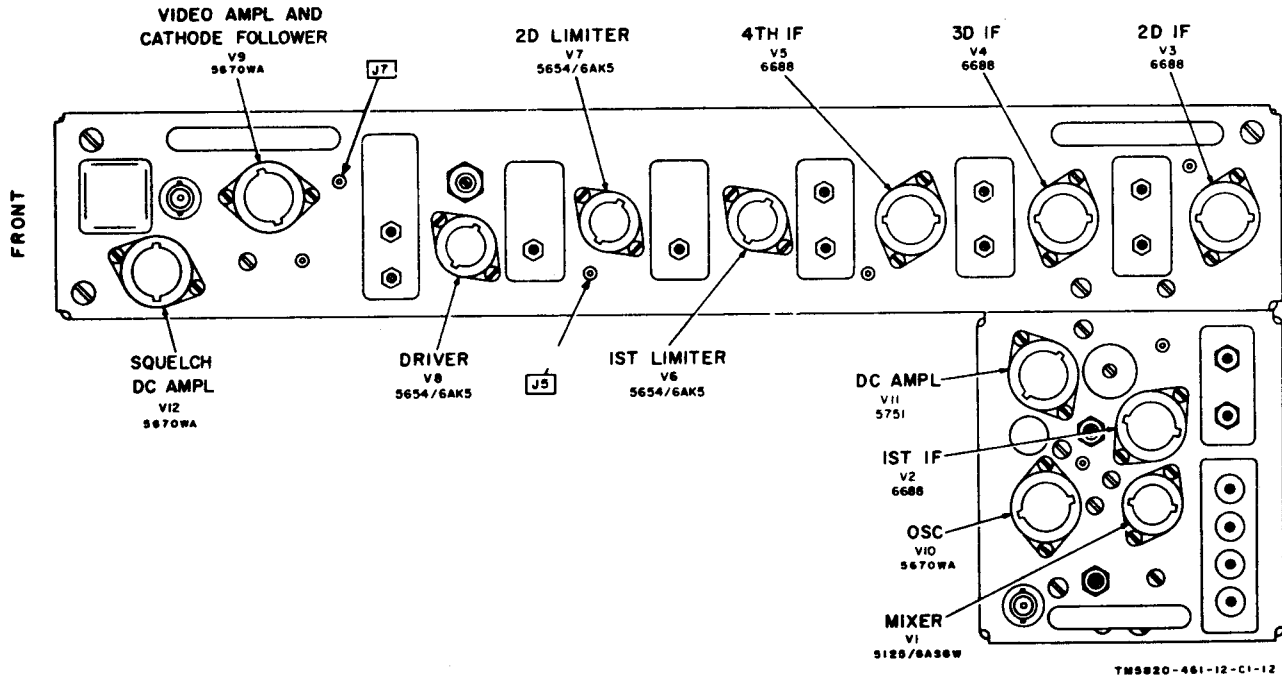

Figure 5-8. Second IF assembly 3A5 (part of R-1148(P)/GRC or R-1331(*) (P)/GRC), tube locations.

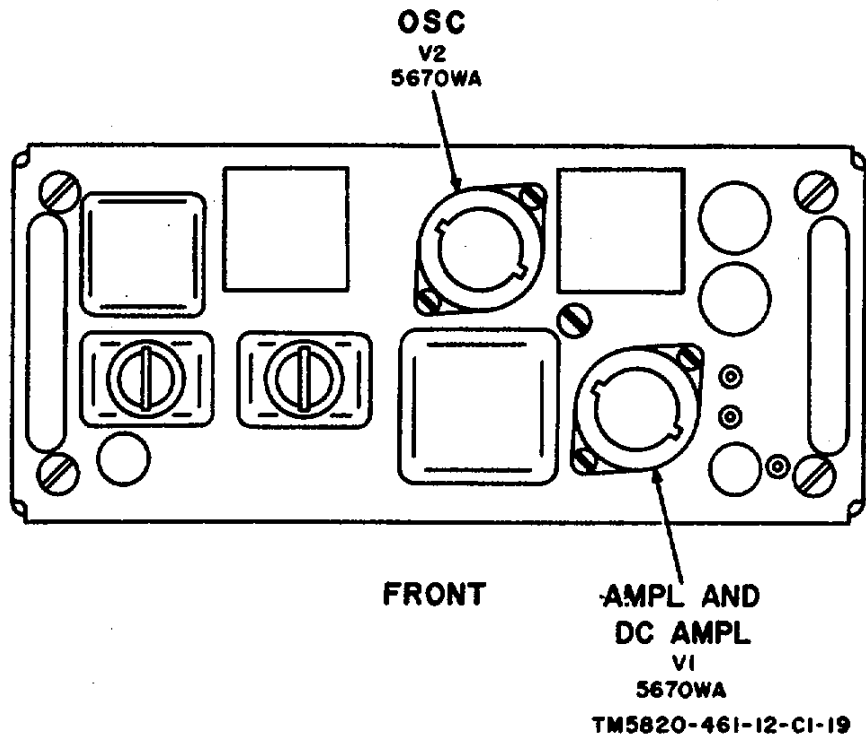

Figure 5-9. Signaling Unit 3A6 (part of R-1148(p)/GRC or R-1331 (*) (P)/grc), tube locations.

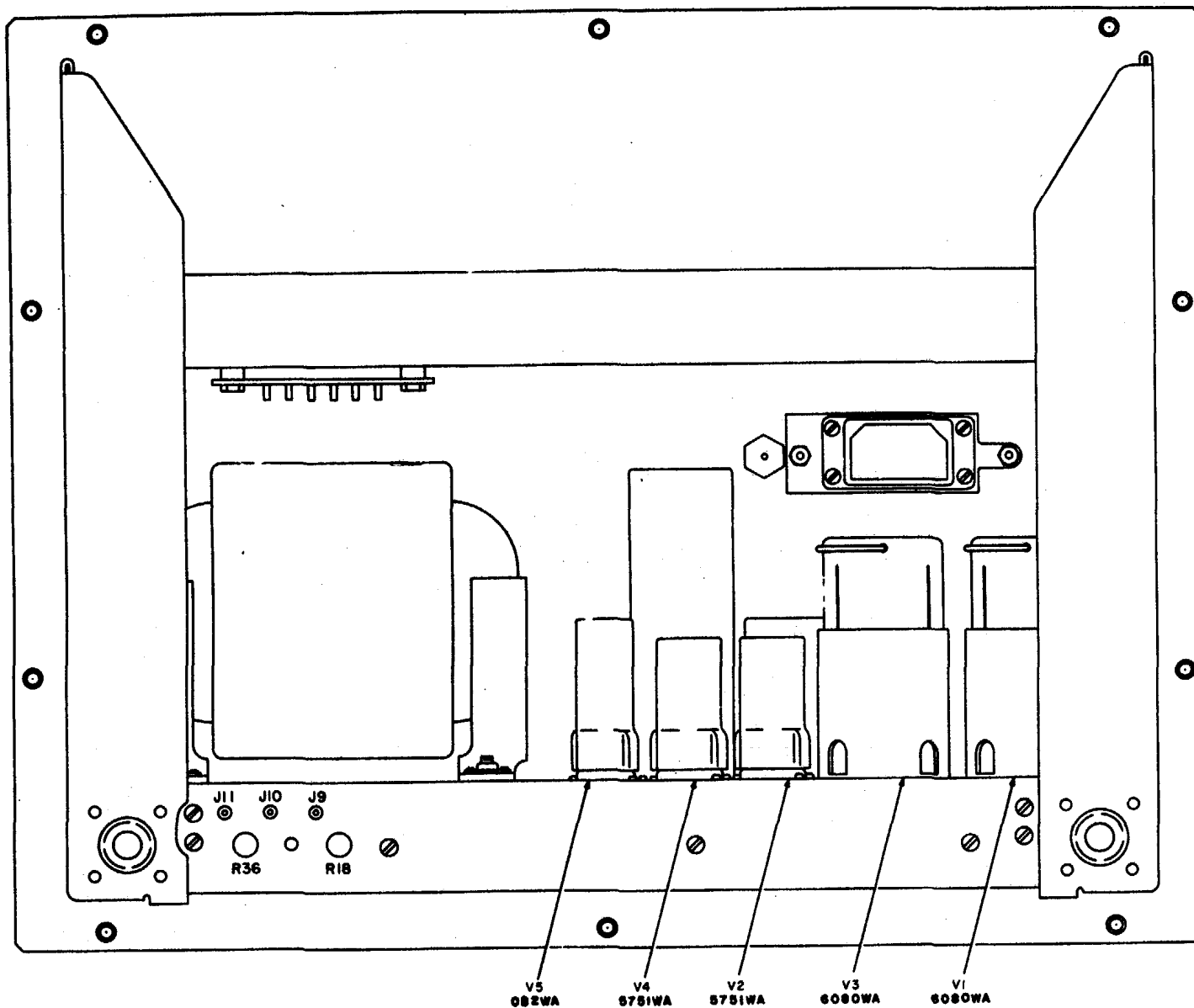
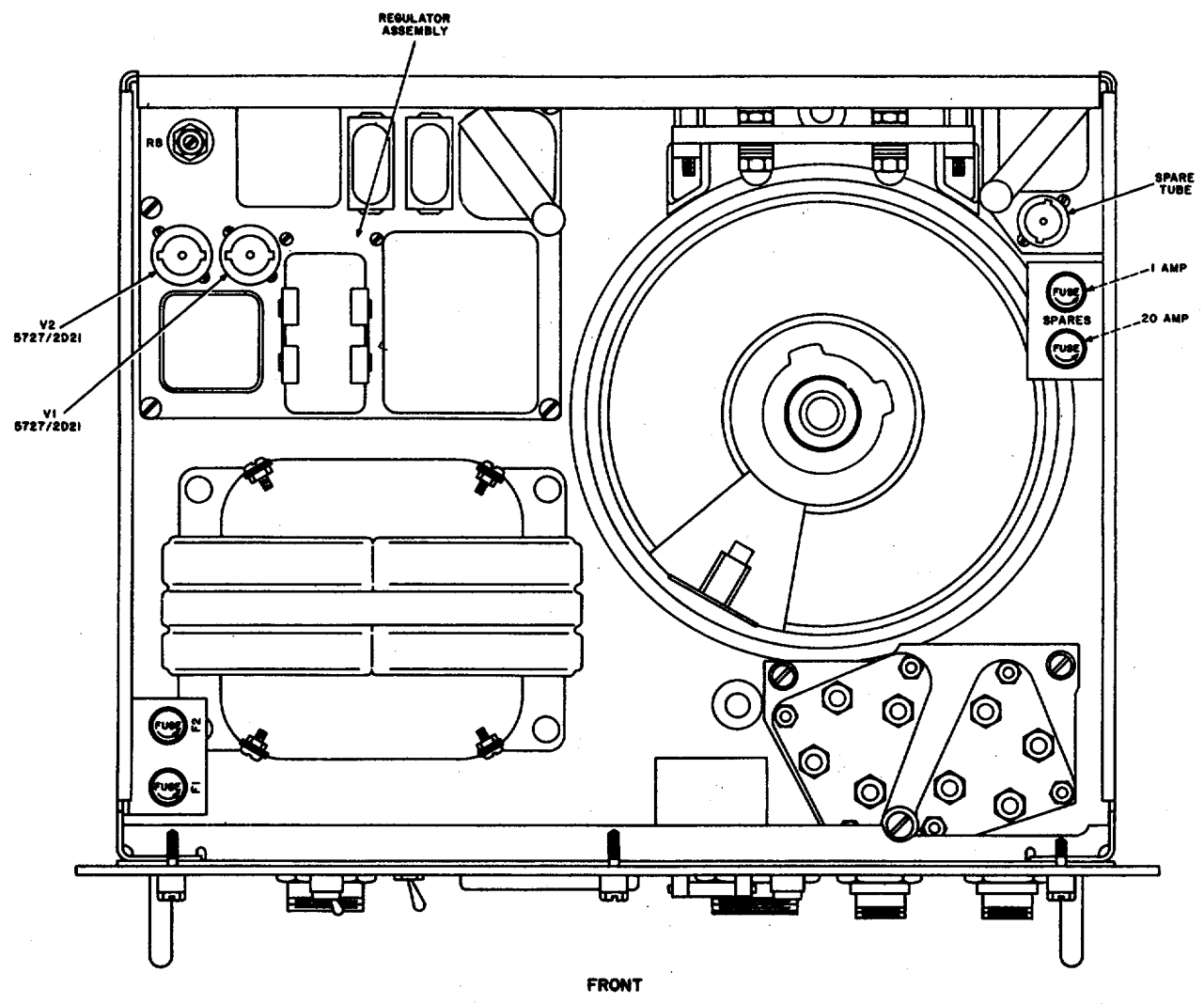

Figure 5-10. R-1331(*) (P) / GRC, Main frame, rear view tube and test point locations .

Change 4 5-34



TM5820-461-12-C1-31

Figure 5-11. CN-514/GRC, top view, tube, fuses, and regulator assembly locations.

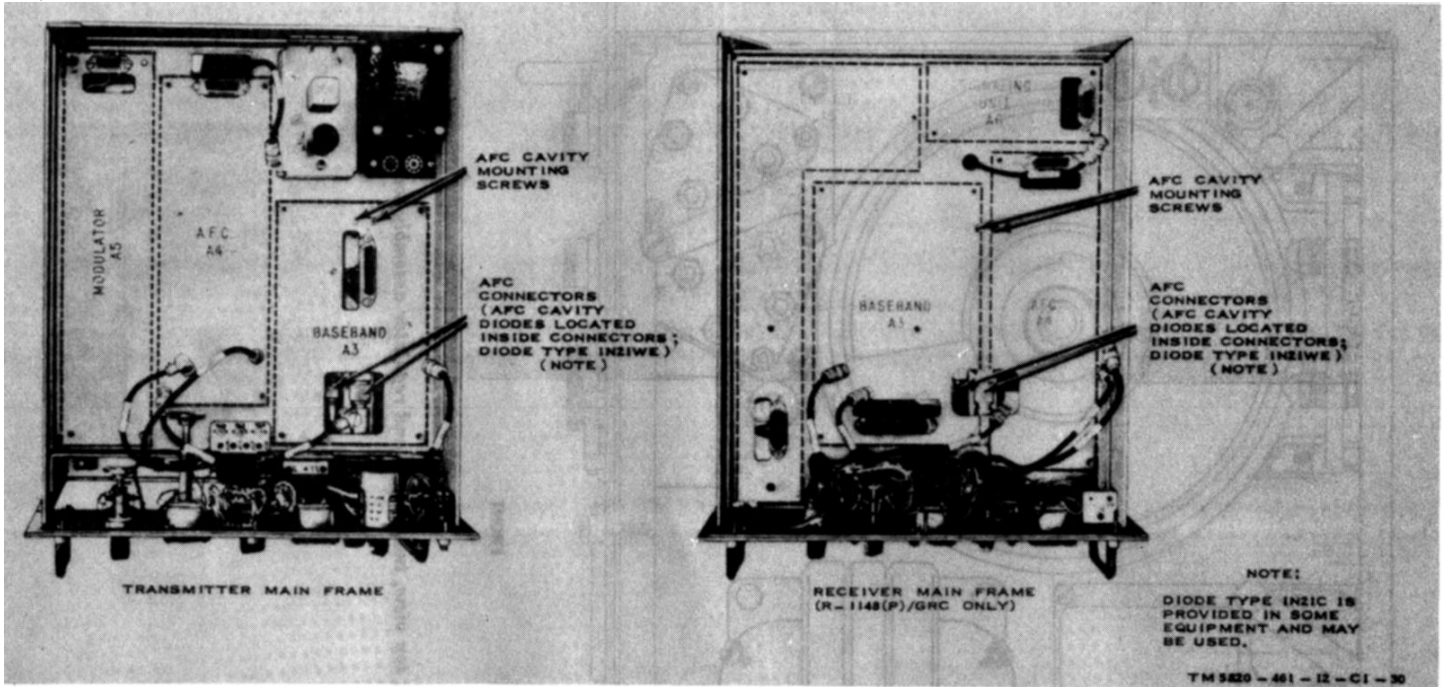

Figure 5-12. T-893(P)/GRC and R-1148(P)/GRC, top views, plug-in assemblies removed, diode locations.

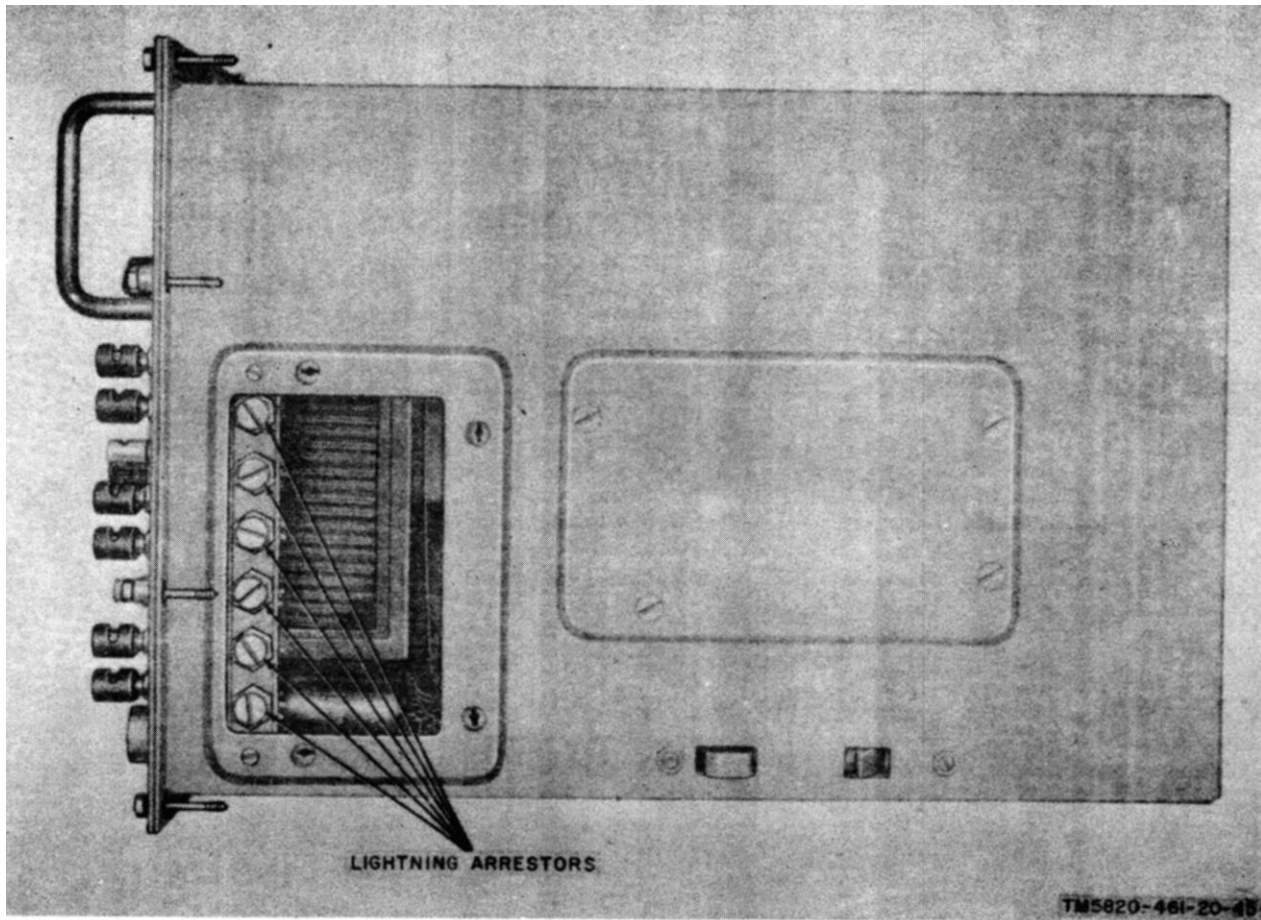

Figure 5-13. R-1148(P)/GRC or R-1331() (P)/GRC, lightning arrester location.*

CHAPTER 6
SHIPMENT, LIMITED STORAGE, AND DESTRUCTION
TO PREVENT ENEMY USE

6-1. Disassembly of Equipment

a. *General* The following instructions are recommended as a guide for preparing the radio set for shipment and limited storage. The instructions include the disconnection of equipment (*b* through *e* below), removal of the equipment (para 6-2), and disconnection and disassembly of the AB-5 77/GRC and AT-903/G.

b. *Switch Box SA-640/GRC (If Provided).*

- (1) Disconnect Cable Assembly, Power, Electrical CX-4686/U from the power source.
- (2) Disconnect Cable Assembly, Power, Electrical CX-4686/U from the ac power sources and the AC POWER INPUT connector on Regulator, Voltage CN-514/GRC.
- (3) Place the cables on Reel, Cable RC-404/TR.
- (4) Remove the ground wire connections.

c. *Regulator Voltage CN-514/GRC.*

- (1) Disconnect the CX-4559/U from the ac power output connector on the CN-514/GRC and the AC POWER connector on Power Supply PP-2054(*)/GRC.
- (2) Disconnect the CX-4559/U from the ac power output connector on the CN-514/GRC and the AC POWER connector on the 115 VOLTS connector on the R-1148(P)/GRC or R-1331(*)/GRC.

d. *Power Supply PP-2054 (*)/GRC and Transmitter, Radio T -8 93(P)/GRC.*

- (1) *PP-2054(*)/GRC.*
 - (a) Remove the common ground connection from the GRD connector on the PP-2054(*)/GRC.
 - (b) Disconnect the cable from the RPTR ALARM CONN connector between the two PP-2054(*)/GRC power supplies in a repeater installation.
 - (c) Disconnect the CX 4558/U from the TO XMTR connector on the PP-2054(*)/GRC and the TO PWR SUP connector on the T-893(P)/GRC.
- (2) *T-8 93(P)/GRC and AM-19571GRC or AM-1958(*)/GRC.*
 - (a) Remove the antenna cable from the TO ANT connector on the AM-19571GRC or AM-1958(*)/GRC.
 - (b) Disconnect the CG-718B/U from the TO REC connector on the AM-19571GRC or AM-1958(*)/GRC and the RF INPUT connector on the AM-1955(*)/GRC or AM-1956(*)/GRC.
 - (c) Disconnect Cable Assembly, Special Purpose, Electrical CX-4557/U from the TO RCVR connector on the T-893(P)/GRC and the TO XMTR connector on the R-1148(P)/GRC or R- 1331(*)/GRC.
 - (d) Remove the cable connected to the PCM IN connector on the T-893(P)/GRC. This cable is a part of the associated pcm multiplex installation.

e. *Receiver, Radio R-1148(P)/GRC or R-1331(*)/GRC.*

- (1) Remove the cables connected to the PCM ORDER WIRE and the PCM OUT connector on the R-1148(P)/GRC or R-1331(*) (P)/GRC. These cables are a part of the associated pcm multiplex installation.
- (2) Remove the handset cable connected to the HANDSET connector on the R-1148(P)/GRC or R-1331(*)/GRC.
- (3) Remove the order wire cables attached to the REMOTE ORDER WIRE connectors on the R-1148(1) GRC or R-1331(*)/GRC.
- (4) Remove the spiral-four cable from the RCVR OUT, the GRD, and the XMTR IN connections on the R-1148(P)/GRC or

R-1331(*)/P/GRC. This cable is a part of the associated fdm multiplex installation.

6-2. Removal of Equipment

After the radio set has been electrically disconnected, perform the following procedures.

- (a) Operate the multimeter selector switch on the T-1148(P)/GRC or R-1331(*)/P/GRC and the T893(P)/GRC to the OFF (TRANSIT) position. This action protects the meter movement during transit of the equipment.
- b. If the wavemeter charts have been removed from the AM-1955(*)/GRC, or AM-1956(*)/GRC, and the AM-1957GRC or AM-1958(*)/GRC, replace the charts in the WAVEMETER CHART slots. Check each chart to make sure that it is connected to the same serial numbered assembly for which it was designated.
- c. Place all spare parts and accessories in the spare parts case and accessory bag. Remove the bag and case from the shelter.
- d. Replace the covers on the component cases and remove the components from the shelter. Place the components in a convenient location for final packaging.
- e. Disassemble the AB-577/GRC (and MK-806/GRC, if provided).
- f. Remove the AT-903/G from the AB-577/GRC. Store the AB-577/GRC components in the AM-577/GRC launcher and canvas bags provided with the AB-577/GRC (fig. 1-8).

6-3. Repackaging for Shipment and Limited Storage

- a. *General.* The exact procedure for repackaging depends on the material available and the conditions under which the radio set is to be shipped or stored. Adapt the procedures outlined in paragraph 6-1 whenever possible. Pack each component in a separate wooden box. Place three dehydrating agents in each box. Figure 2-1 illustrates a typical box. Refer to paragraph 2-1a for the dimensions of the boxes originally supplied with the radio set.
- b. *Material Requirements.* The following materials are required for packaging the radio set. For stock number of materials, consult SB 38-100.

Material	Quantity
Waterproof paper.....	2,528 sq ft
Waterproof tape.....	100 ft
Corrugated cardboard.....	2,528 sq ft
Adhesive tape.....	100 ft
Filler material.....	20 lb
Dehydrating agent.....	3 per carton
Cotton twine.....	150 ft

6 4. Packaging

The components of the radio set should be packaged as outlined in a and b below. The procedures described in a below apply to the CN-514/GRC, the PP-2054(*)/GRC, the T-8 93(P)/GRC (with the AM-1957/GRC or AMC-1958(*)/GRC installed) the R-1148(P)/GRC or R-1331(*)/P/GRC (with the AM-1955(*)/GRC or AM-1956(*)/GRC installed, the alternate tuner ease, and the spare parts accessory case.

- a. *Components Contained in Standard Cases.*
 - (1) Cushion the component on all surfaces of the case with filler material. To hold the filler material in place, wrap strips of adhesive tape over the filler material and around the case.
 - (2) Place the cushioned component in a wrap of corrugated cardboard. Secure the wrap with adhesive tape.
 - (3) Wrap the cardboard-wrapped component with waterproof paper. Seal all openings and secure the wrap with waterproof tape.
- b. *Antenna AT-903/G and Mast AB-577/GRC.*
 - (1) Antenna AT-903/G. Perform the following procedures to package the AT-903/G:
 - (a) Check to see that the elevation depression bracket is in the 0° position. Lock the locking handle.
 - (b) Cushion the AT-9031G on all surfaces with filler material. To hold the filler material in place, wrap strips of adhesive tape over the filler material and around the component.
 - (c) After the AT-903/G has been cushioned, place it in a wrap of corrugated cardboard. Secure the wrap with adhesive tape.
 - (d) Wrap the cardboard-wrapped AT-903/G with waterproof paper. Seal all

TM 11-5820-461-12

openings and secure the wrap with waterproof tape.

(2) *Mast AB-577/GRC.* No further packaging of the AB-577/GRC is required after the mast sections have been replaced in the mast-section carrier. Place the mast-section carrier in a convenient location for final packing.

(3) *Accessory bag and roll.* Place all the antenna accessories in the canvas roll and accessory bag (fig. 1-8). No further packaging is required after the accessories have been secured in place.

6-5. Destruction of Army Material to Prevent Enemy Use (Electronics Command)

Refer to TM 750-244 2 for information concerning destruction of Army materiel.



APPENDIX A

REFERENCES

DA Pam 310-4	Index of Technical Manuals, Technical Bulletins, Supply Manuals (Types 7, 8, and 9), Supply Bulletins, and Lubrication Orders
DA Pam 310-7	Index of Modification Work Orders
FM 5-25	Explosives and Demolitions
FM 21-26	Map Reading
SB 38-100	Preservation, Packaging, Packing and Marking Materials, Supplies, and Equipment Used by the Army
TB SIG 291	Safety Measures to be Observed When Installing and Using Whip Antennas, Field Type Masts, Towers, Antennas, and Metal Poles that are Used With Communication, Radar, and Direction Finder Equipment
TB 746-10	Field Instructions for Painting and Preserving Electronics Command Equipment
TM 11-486-6	Electrical Communications Systems Engineering: Radio
TM 11-5805-201-12	Organizational Maintenance Manual: Telephone Set TA-312/PT
TM 11-5805-247-12	Organizational Maintenance Manual: Converter, Telegraph Telephone Signal TA-182/U
TM 11-5820-461-25P	Organizational, DS, GS, and Depot Maintenance Repair Parts and Special Tool Lists: Radio Sets AN/GRC-50(V)1, 2, 3, 4, and 5 and AN/GRC-50A(V)1, 2, 3, 4, and 5
TM 11-5820-517-12P	Operator and Organizational Maintenance Repair Parts and Special Tool Lists and Maintenance Allocation Chart: Antenna AT-903/G
TM 11-5820-533-14	Organizational, DS, GS, and Depot Maintenance Manual, Including Repair Parts and Special Tool Lists: Repeater Set, Radio AN/ MR C 103(V).
TM 11-5820-535-15	Operator, Organizational, DS, GS, and Depot Maintenance Manual, Including Repair Parts and Special Tool Lists: Repeater Set, Radio AN/TRC-110(V).
TM 11-5820-536-15	Organizational, DS, GS, and Depot Maintenance Manual, Including Repair Parts and Special Tool Lists: Repeater Set, Radio AN/ TRC-109(V).
TM 11-5820-538-12	Operator's and Organizational Maintenance Manual Including Repair Parts and Special Tools Lists: Mast AB-577/GRC and Extension Kit, Mast MK-806/GRC.
TM 11-5896 357-14	Operator, Organizational, Direct Support and General Support Maintenance Manual, Including Repair Parts and Special Tool Lists: Radio Terminal Set AN/MRC-102(V)
TM 11-5895-366-15	Operator, Organizational, DS, GS, and Depot Maintenance Manual: Radio Terminal Set AN/TRC-117(V)
TM 11-5895-367-15	Organizational, DS, GS, and Depot Maintenance Manual: Radio Terminal Set AN/TRC- 108(V)
TM 11-6110-245-15	Operator, Organizational, DS, GS, and Depot Maintenance Manual: Voltage Regulator CN-514/ARC.

TM 11-5820-461-12

TM 11-6625-203-12
Multimeter ME-77/U
TM 11-6625-274-12
TV-7A/U, TV-
TM 38-750
TM 750-244-2

Operator and Organizational Maintenance: Multimeter AN/URM- 105, Including

Operator's and Organizational Maintenance Manual: Test Sets, Electron Tube TV-7/U,
7B/U, and TV-7D/U

The Army Maintenance Management Systems (TAMMS)

Procedures for Destruction of Army Materiel to Prevent Enemy Use (Electronics
Command)

APPENDIX C
MAINTENANCE ALLOCATION

Section I. INTRODUCTION

C-1. General

This appendix provide summary of the maintenance operations for AN/GRC-50(V)1 thru 5 and AN/GRC-50A(V)1 thru 11. It authorizes categories of maintenance for specific maintenance functions on repairable items and components and the tools and equipment required to perform each function. This appendix may be used as an aid in planning maintenance operations.

C-2. Maintenance Function

Maintenance functions will be limited to and defined as follows:

- a. *Inspect.* To determine the serviceability of an item by comparing its physical, mechanical, and/or electrical characteristics with established standards through examination.
- b. *Test.* To verify serviceability and to detect incipient failure by measuring the mechanical or electrical characteristics of an item and comparing those characteristics with prescribed standards.
- c. *Service.* Operations required periodically to keep an item in proper operating condition, i.e., to clean (decontaminate), to preserve, to drain, to paint, or to replenish fuel, lubricants, hydraulic fluids, or compressed air supplies.
- d. *Adjust.* To maintain, within prescribed limits, by bringing into proper or exact position, or by setting the operating characteristics to the specified parameters.
- e. *Align.* To adjust specified variable elements of an item to bring about optimum or desired performance.
- f. *Calibrate.* To determine and cause corrections to be made or to be adjusted. on instruments or test measuring and diagnostic equipments used in precision measurement. Consists of comparisons of two instruments, one of which is a certified standard of known accuracy, to detect and adjust any discrepancy in the accuracy of the instrument being compared.
- g. *Install* The act of emplacing, seating, or fixing into position an item, part, module (component or assembly) in a manner to allow the proper functioning of the equipment or system.
- h. *Replace.* The act of substituting a serviceable like type part, subassembly, or module (component or assembly) for an unserviceable counterpart.
- i. *Repair.* The application of maintenance services (inspect, test, service, adjust, align calibrate, replace) or other maintenance actions (welding, grinding, riveting, straightening, facing, remachining, or resurfacing) to restore serviceability to an item by correcting specific damage, fault, malfunction, or failure in a part, subassembly, module (component or assembly), end item, or system.
- j. *Overhaul.* That maintenance effort (service/action) necessary to restore an item to a completely serviceable/operational condition as prescribed by maintenance standards (i.e., DMWR) in appropriate technical publications. Overhaul is normally the highest degree of maintenance performed by the Army. Overhaul haul does not normally return an item to like new condition.
- k. *Rebuild.* Consists of those services/actions necessary for the restoration of unserviceable equipment to a like new condition in accordance with original manufacturing standards. Rebuild is the highest degree of materiel maintenance applied to Army equipment. The rebuild operation includes the act of returning to zero those age measurements (hours, miles, etc.) considered in classifying Army equipments/components

C-3. Column Entries

- a. *Column 1, Group Number.* Column 1 lists group numbers, the purpose of which is to identify components, assemblies, subassemblies, and modules with the next higher assembly.
- b. *Column 2, Component/Assembly.* Column 2 contains the noun names of components, assemblies, subassemblies, and modules for which maintenance is authorized.
- c. *Column 3, Maintenance Functions.* Column 3 lists the functions to be performed on the item listed in column 2. When items are listed without maintenance functions, it is solely for purpose of having the group numbers in the MAC and RPSTL coincide.
- d. *Column 4, Maintenance Category.* Column 4 specifies, by the listing of a "work time" figure in the appropriate subcolumn(s), the lowest level of maintenance authorized to perform the function listed in column 3. This figure represents the active time required to perform that maintenance function at the indicated category of maintenance. If the number or complexity of the tasks within the listed maintenance function vary

at different maintenance categories, appropriate "work time" figures will be shown for each category. The number of task-hours specified by the "work time" figure represents the average time required to restore an item (assembly, subassembly, component, module, end item or system) to a serviceable condition under typical field operating conditions. This time includes preparation time, troubleshooting time, and quality assurance/quality control time in addition to the time required to perform the specific tasks identified for the maintenance functions authorized in the maintenance allocation chart. Subcolumns of column 4 are as follows:

- C — Operator/Crew
- O — Organizational
- F — Direct Support
- H — General Support
- D — Depot

e. *Column 5, Tools and Equipment.* Column 5 specifies by code those common tool sets (not individual tools) and special tools, test, and support equipment required to perform the designated function

f. *Column 6, Remarks.* Column 6 contains an alphabetic code which leads to the remark in section IV, Remarks, which is pertinent to the item opposite the particular code.

C-4 Tool and Test Equipment Requirements (See III)

a. *Tool or Test Equipment Reference Code.* The numbers in this column coincide with the numbers used in the tools and equipment column of the MAC. The numbers indicate the applicable tool or test equipment for the maintenance functions.

b. *Maintenance Category.* The codes in this column indicate the maintenance category allocated the tool or test equipment.

c. *Nomenclature.* This column lists the noun name and nomenclature of the tools and test equipment required to perform the maintenance functions.

d. *National/NATO Stock Number.* This column lists the National/NATO stock number of the specific tool or test equipment.

e. *Tool Number.* This column lists the manufacturers part number of the tool followed by the National Supply Code for Manufacturers (5-digit) in parentheses.

C-5. Remarks (Sec IV)

a. *Reference Code.* This code refers to the appropriate item in section II, column 6.

b. *Remarks.* This column provides the required explanatory information necessary to clarify items appearing in section II.

(Next printed page is C-3)

SECTION II MAINTENANCE ALLOCATION CHART
 FOR
 RADIO SETS AN/GRC -50(V)1 THRU 5
 AND AN/GRC-50(V)1 THRU 11

(1) GROUP NUMBER	(2) COMPONENT/ASSEMBLY	(3) MAINTENANCE FUNCTION	(4) MAINTENANCE CATEGORY					(5) TOOLS AND EQUIPMENT	(6) REMARKS
			C	O	F	H	D		
00	RADIO SETS AN/GRC-50(V)1 thru 5 and AN/GR50A(V)1 thru 11	Inspect	0.1					3	C
		Inspect		0.4				3	B
		Inspect			1.1			14,15	D
		Test	0.2					1,2,3,37,40,48	F
		Test		0.6				4 thru 13,16	E
		Test			1.0			4 thru 35,37,39,40,48	G
		Test				2.4		4 thru 48	H
		Test	0.1					8.0	A
		Service		0.5				3	B
		Service			1.2			14,15	J
		Service	0.1					1,2,3,37,40,48	K
		Adjust		0.5				4 thru 16,34,37,40,48	M
		Adjust			0.9			4 thru 35,37,39,40,48	O
		Adjust				1.8		4 thru 48	O
		Adjust					2.0	4 thru 35,37,39,40,48	L
		Align						4.5	N
		Align						3.1	I
		Install	0.2	0.5				4 thru 48	3
		Repair		0.2				1 thru 3	Q
		Repair				0.8		1 thru 3,37,40,48	Q
Repair					1.6	14,15	R		
Repair						4 thru 35,37,39,40,48	R		
Repair						4 thru 48	S		
Overhaul					4.0	5.0	4 thru 35,37,39,48	U	
Overhaul						5.0	4 thru 48		
01	RECEIVER, RADIO R-1148 (P)/GRC and R-1331(*) (P)/GRC(3)	Inspect	0.1					3	A
		Inspect		0.1				3	B
		Test	0.1					3	D
		Test		0.6				1,2,37,48	D
		Test				2.8		4 thru 35,37,39,48	E
		Test					4.1	4 thru 48	H
		Service	0.1					14,15,	A
		Service		0.6				1 thru 3	B
		Adjust	0.3					37,48	K
		Adjust		0.7				1 thru 3	M
		Align				2.1		37,48	
		Align					4.3	4 thru 35,37,39,48	W
		Align						4 thru 35,37,39,48	V
		Replace		0.6				4 thru 16,34,37,48	Y
		Repair			1.1			4 thru 35,37,39,40,48	U
Repair					4.3	4 thru 35,37,39,40,48	U		
Overhaul					4.7	4 thru 35,37,39,48	U		
Rebuild						5.8	4 thru 48,		
Repair						5.8	4 thru 48	P	
Repair		0.6				1 thru 3,37,48	X		

SECTION II MAINTENANCE ALLOCATION CHART
 FOR
 RADIO SETS AN/GRC-50(V)1 THRU 5 AND
 AN/GRC-50(V) 1 THRU 11

(1) GROUP NUMBER	(2) COMPONENT/ASSEMBLY	(3) MAINTENANCE FUNCTION	(4) MAINTENANCE CATEGORY					(5) TOOLS AND EQUIPMENT	(6) REMARKS
			C	O	F	H	D		
0101	AMPLIFIER-CONVERTER AM-1955(*)/GRC (3A1)	Inspect	•					3	B
		Test		•	9			1 thru 3, 2 37 40,48	Z
		Test			1 2			4 thru 16,	E
		Service	0.2				3.4	4,37,48	H
		Adjust	0.4					3	B
		Align						1 thru 3	K
		Replace		0.2				4 thru 48	I
		Repair		0.6				3	
		Repair					3.0	1 thru 3 4 thru 35, 37,39,48	X U
		Repair			1.1			14,15	AC
		Overhaul				4.0		4 thru 35, 37,39,48	U
		Rebuild					5.0	4 thru 48	
		Repair					3.0	4 thru 48	S
		010101	1ST IF SUBASSEMBLY (3A1A1)	Inspect	0.9				3
Test					1.2		4 thru 16 34,39,48	AI	
Service					0.8		14,15	J	
Adjust						1.8	4 thru 35, 37,39,48	AE	
Replace					0.33		14,15		
Repair						2.0	4 thru 35, 37,39,48	P	
Overhaul						2.1	4 thru 35, 37,39,48	P	
Rebuild					4.0	4 thru 48			

**SECTION II MAINTENANCE ALLOCATION CHART
FOR
RADIO SETS AN/GRC-50(V)1 THRU 5 AND
AN/GRC-50A(V)1 THRU 11**

(1) GROUP NUMBER	(2) COMPONENT/ASSEMBLY	(3) MAINTENANCE FUNCTION	(4) MAINTENANCE CATEGORY					(5) TOOLS AND EQUIPMENT	(6) REMARKS
			C	O	F	H	D		
0102	AMPLIFIER-CONVERTER A-1956(-)/GRC (3A2)	Inspect Test		0.9				3 1 thru 3 37,48	B Z
		Test			1 2			4 thru 16, 35, 32 39,48	AA
		Test					3 4	4 thru 48	H
		Service Adjust Align	0 2 0 4					3 3 4 6	B K I
		Replace Repair		0 2 0 6				48 3 1 thru 3 37 48	X
		Repair Repair			1 1	3 0		14 15 4 thru 35,37,39 48	AC U
		Repa1r					3 0	4 thru 48	S
		Overhaul				4 0		4 thru 35,37, 38,48	U
		Rebuild					5.0	4 thru 48	
		010201	IST IF SU8ASSEIILY (3A2A1)	Inspect Test			0-9 1 2		
Service					0 8			4 thru 16,34, 37,39	AB
Adjust						1-1		4 thru 35,37, 39,48	AE
Align						1 8		4 thru 35,37, 39,48	I
Replace Repair					0 33	2 0		14,15 4 thru 35,37, 39,48	P
Overhaul						2 1		4 thru 35,37, 39,48	P
Rebuild							4.0	4 thru 48	
0103	RECEIVER BASE BAND ASSEMBLY (3A3)	Inspect Test		0.1	1.1			4 thru 16,34, 37,39, 48	A E
		Test				1 8		4 thru 35,37, 39,48	H
		Test					2 9	4 thru 48	H
		Align				1.5		4 thru 35,37, 39,48	W
		Align					2 3	4 thru 48	I
		Replace Repair			0 25		1 6	14,15 4 thru 48	P
		Overhaul Rebuild					3 0 5.0	4 thru	P,T

SECTION II MAINTENANCE ALLOCATION CHART
 FOR
 RADIO SETS AN/GRC-50(V)1 THRU 5 AND
 AN/GRC-50A(V)1 THRU 11

(1) GROUP NUMBER	(2) COMPONENT/ASSEMBLY	(3) MAINTENANCE FUNCTION	(4) MAINTENANCE CATEGORY					(5) TOOLS AND EQUIPMENT	(6) REMARKS
			C	O	F	H	D		
0104	RECEIYER AFC ASSEMBLY (3A4)	Inspect	0.1		1.1			4 thru 16	A
		Test						34,37,39,48	G
		Test				1.8		4 thru 35,37,39,48	G
		Test					2.9	4 thru 48	H
		Align				1.5		4 thru 35,37,39,48	W
		Align						4 thru 48	I
		Replace Repair		0.25		2.6		14,15 4 thru 35 37,39,48	P
0105	RECEIVER 2ND IF ASSEMBLY (3A5)	Overhaul				3.0	4 thru 35,37,39,48	P,T	
		Rebuild					5.0	4 thru 48	
		Inspect		0.1				1 thru 3	A
		Test			1.1			4 thru 16,34,37,39,48	G
		Test				1.8		4 thru 35,37,39,48	G
		Test					2.9	4 thru 48	H
		Align				1.5		4 thru 35,37,39,48	W
0106	RECEIVER-SIGNAL UNIT (3A6)	Align					4 thru 48	I	
		Replace Repair			0.25		14,15 4 thru 35,37,39,48	P	
		Overhaul				3.0		4 thru 35,37,39	
		Rebuild					5.0	4 thru 48	
		Inspect		0.1					A
		Test			1.1			4 thru 16,34,37,39,48	G
		Test				1.8		4 thru 35,37,39,48	G
02	TRANSMITTER, READIO T-893(P)/GRC (2)	Test					4 thru 48	H	
		Align				2.9		4 thru 48	V
		Replace Repair			0.25	1.5		4 thru 48 14,15	
		Overhaul					1.6	4 thru 48	P
		Rebuild					3.0	4 thru 48	P,T
		Inspect	0.1					4 thru 48	A
		Inspect		0.5				1 thru 35,37,39,40,48	B
02	TRANSMITTER, READIO T-893(P)/GRC (2)	Test	0.2					1 thru 35,39,40,48	D
		Test		0.6				4 thru 16,35,37,39,40,48	F
		Test			1.0			4 thru 35,37,39,40,48	AF
		Test				1.9		4 thru 35,37,39,40,48	G
		Test					2.4	4 thru 48	H
		Service	0.1					3	A
		Service						4 thru 37,39,40,48	B
		Align		0.6		2.0		4 thru 48	W
		Align					2.8	4 thru 48	I
		Replace Repair		0.5				14,15	X
02	TRANSMITTER, READIO T-893(P)/GRC (2)	Repair		0.6	1.2			3 4 thru 16,34,37,39,39,40,48	AH
		Repair				2.1		4 thru 35,37,39,40,48	R
		Overhaul					2.6	4 thru 48	P,T
		Rebuild					5.0	4 thru 48	

SECTION II MAINTENANCE ALLOCATION CHART
FOR
RADIO SET AN/GRC-50(V)1 THRU 5 AND
AN/GRC-50(V)1 THRU 11

(1) GROUP NUMBER	(2) COMPONENT/ASSEMBLY	(3) MAINTENANCE FUNCTION	(4) MAINTENANCE CATEGORY					(5) TOOLS AND EQUIPMENT	(6) REMARKS	
			C	O	F	H	D			
0201	TRANSMITTER BASE BAND ASSEMBLY (2A3)	Inspect		0.4				3	B	
		Test			1.0			4 thru 16, 34,37,39, 40,48	AF	
		Test						1.9	4 thru 48	AG
		Adjust						1.9	4 thru 48	L
0202	TRANSMITTER MODULATOR ASSEMBLY (2A4)	Align						1.8	4 thru 48	I
		Replace			2.5				14,15	
		Repair				2.3			4 thru 35, 4 thru 35, 48	R
		Overhaul						3.2	4 thru 48	P,T
0202	TRANSMITTER MODULATOR ASSEMBLY (2A4)	Rebuild						5.2	4 thru 48	
		Inspect		0.4					1 thru 3	A
		Test			1.0				4 thru 16, 34,37,39, 40,48	AF
		Test					1.9		4 thru 35, 37,39,40, 48	AG
0203	TRANSMITTER AFC ASSEMBLY (2A5)	Adjust						1.1	4 thru 35, 4 thru 35, 48	O
		Align					1.8		4 thru 35, 37,39,40, 48	M
		Replace			0.25				14,15	
		Repair				2.3			4 thru 35, 37,39,40, 48	R
0203	TRANSMITTER AFC ASSEMBLY (2A5)	Overhaul						3.2	4 thru 48	4 thru 35,
		Rebuild						5.2	4 thru 48	
		Inspect		0.4					1 thru 3	A
		Test			1.0				4 thru 16, 37,38,39, 40,48	AG
0203	TRANSMITTER AFC ASSEMBLY (2A5)	Test					1.9		4 thru 35, 37,39,40, 48	AG
		Adjust						1.1	4 thru 35, 37,39,40, 48	O
		Align					1.8		4 thru 35, 37,39,40, 48	M
		Replace			0.25				4 thru 16, 34,37,39, 40,48	
0204	TRANSMITTER REGULATOR ASSEMBLY (2A6)	Repair						2.3	4 thru 35, 37,39,40, 48	R
		Repair						2.1	4 thru 35, 40	P
		Overhaul						2.2	4 thru 35, 40	P,T
		Rebuild						4.6	4 thru 48	
0204	TRANSMITTER REGULATOR ASSEMBLY (2A6)	Inspect		0.4					4 thru 16, 35,37,39, 40,48	A
		Test			1.0				4 thru 48	AG
		Test						1.9	4 thru 48	AG
		Adjust						1.9	4 thru 48	L
0204	TRANSMITTER REGULATOR ASSEMBLY (2A6)	Align						1.8	4 thru 48	I
		Replace			0.25				14,15	
		Repair				2.1			4 thru 35, 38,40	AJ
		Repair						2.3	4 thru 48	R
0204	TRANSMITTER REGULATOR ASSEMBLY (2A6)	Overhaul						3.2	4 thru 48	P,T
		Rebuild						5.2	4 thru 48	

SECTION II MAINTENANCE ALLOCATION CHART
FOR
RADIO SETS AN/GRC-50(V)1 THRU 5 AND
AN/GRC-50A(V)1 THRU 11

(1) GROUP NUMBER	(2) COMPONENT/ASSEMBLY	(3) MAINTENANCE FUNCTION	(4) MAINTENANCE CATEGORY					(5) TOOLS AND EQUIPMENT	(6) REMARKS
			C	O	F	H	D		
0205	AMPLIFIER-OSCILLATORS AM-1957/GRC (2A1)	Inspect	0.1					1,2,40,48	A
		Test						4 thru 35,	F
		Test		0.6				40	H
		Service	0.1					1 thru 3	A
		Adjust	0.6					1 thru 3	K
		Adjust					4.8	4 thru 48	L
		Replace		0.25				3	
		Repair		0.7				1 thru 3	X
		Repair					4.7	4 thru 48	S
		Overhaul					5.7	4 thru 48	P,T
		Rebuild				6.5	4 thru 48		
03	DUMMY LOAD, ELECTRICAL DA-189/G	Inspect	0.1					3	A
		Test					1.2	4 thru 48	H
		Service		0.4				1 thru 3	A
		Adjust					0.9	4 thru 48	L
		Align					0.8	4 thru 48	I
		Repair					2.1	4 thru 35,	P
								40	
		Overhaul					2.2	4 thru 35,	4 thru 48
		Rebuild				4.6	4 thru 48		
04	POWER SUPPLY PP-2054(*)/GRC	Inspect	0.1					3	A
		Test	0.1					1 thru 3	D
		Test		0.6				1 thru 3,	F
								37	
		Test			1.2			4 thru 16,	AI
								37,48	
		Test					4.1	4 thru 48	V
		Service	0.1					3	A
		Adjust	0.1					1 thru 3,	K
				0.5				37,48	O
					1.8	1 thru 3,			
		Repair				37,48	4 thru 16,	AJ	
						34,37,39,			
		Overhaul				40,48	4 thru 48	P,T	
		Rebuild				2.1	4 thru 48		
						3	4 thru 48		
05	REGULATOR VOLTAGE CN-514/GRC (10) (11)	Inspect	0.1					3	A
		Test		0.3				1 thru 3,	D
								37,48	
		Test			0.5			4 thru 16,	Z
								34,37,48	
		Service	0.1					3	A
		Adjust			0.9			4 thru 16,	O
					0.9	35,37,48			
		Repair					4 thru 35,	AJ	
							37,39,48		
		Overhaul					4 thru 48	P,T	
		Rebuild				3.1	4 thru 48		
						4.6	4 thru 48		
06	SWITCH BOX SA-640/U	Inspect	0.1					3	A
		Inspect		0.4				1 thru 3	B
		Test	0.2					1 thru 3	D
		Test		0.5				1 thru 3	AI
								37	
		Test			0.8			14,15	AI
		Repair			0.9			14,15	AJ
					1.9	7,14,15	AJ		
		Overhaul					4 thru 48		
		Rebuild					4 thru 48		

SECTION II MAINTENANCE ALLOCATION CHART
FOR
GENERATOR, SIGNAL AN/URM-149

(1) GROUP NUMBER	(2) COMPONENT/ASSEMBLY	(3) MAINTENANCE FUNCTION	(4) MAINTENANCE CATEGORY					(5) TOOLS AND EQUIPMENT	(6) REMARKS
			C	O	F	H	D		
07	HOLDER, HAND SET MT-2161/U	Inspect	0.1					3	A
		Test		0.4				3	D
		Service	0.1					3	A
		Repair		0.5				3	AJ
08	ACCESSORY BAG BG-102A (5MP2)	Inspect	0.1					3	C
		Repair		0.5				3	AK
09	ANTENNA AT-903/G (1) (SEE TM 11-5820-517-14P FOR PARTS)	Inspect	02					1 thru 3	A
		Test		0.6				1 thru 3	AI
		Test			0.2			7	AI
		Service	0.2					1 thru 3	A
		Repair Overhaul Rebuild		0.1			1.5	1 thru 3 7,14,15 7,14,15	AK
10	MAST AB-577/GRC (9) (SEE TM 11-5810-538-14)								
11	HAND SET H-156/U (5HS1)	Inspect	0.1					3	A
		Test	0.2					1 thru 3, 48	D
		Test			0.5			7,11,48	AI
		Replace		0.1				3	
		Repair Overhaul			0.9		1.5	14,15 7,11,13	AJ AJ
12	CASE, STANDARDIZED COMPONENT CY-2582 (7)	Rebuild					14		
		Inspect Overhaul	0.1				2.0	7,11,13, 14	
13	CASE, STANDARDIZED COMPONENT CY-2583 (8)	Inspect	0.1					3	C
		Overhaul		0.5				3	D
14	CABLE ASSEMBLIES	Inspect	0.1					3	C
		Test		0.1				1 thru 3	D
		Service	0.1					1 thru 3	A
		Repair			0.9			14,15	AK
		Overhaul Rebuild				1.5		14,15 4 thru 48	AJ

SECTION III TOOL AND TEST EQUIPMENT REQUIREMENTS
 FOR
 RADIO SETS AN/GRC-50(V)1 THRU 5
 AND AN/GRC-50A (V)1 THRU 11

TOOL OR TEST EQUIPMENT REF CODE	MAIN TENA NCE CATE GORY	NOMENCLATURE	NATIONAL/NATO STOCK NUMBER	TOOL NUMBER
1	0	MULTIMETER AN/URM-105	6625-00-581-2036	
2	0	TEST SET, ELECTRON TUBE TV-7D/U	6625-00-820-0064	
3	0	TOOL KIT TK-101/G	5180-00-064-5178	
4	F,H,D	METER, FREQUENCY AN/USM-159	6625-00-892-5360	
5	F,H,D	GENERATOR, SIGNAL SG-71/FCC	6625-00-669-0255	
6	F,H,D	MULTIMETER ME-26B, C/U	6625-00-646-9409	
7	F,H,D	MULTIMETER TS-352B/U	6625-00-242-5023	
8	F,H,D	DIGITAL READOUT ELECTRONIC COUNTER AN/USM-267	6625-00-911-6368	
9	F,H,D	GENERATOR, SIGNAL AN/URM-149 (SEE NOTE)	6625-00-903-3501	
10	F,H,D	TEST SET, ELECTRON TUBE TV-2(*)/U	6625-00-669-0263	
11	F,H,D	VOLTMETER, METER ME-30A/U	6625-00-669-0742	
12	F,H,D	TRANSFORMER TF-171/USM	5950-00-503-0632	
13	F,H,D	TEST SET, FACILITIES KIT MK-715/GRC-50	6625-00-868-8335	
14	F,H,D	TOOL KIT TK-100/G	5180-00-605-0079	
15	F,H,D	TOOL KIT TK-105/G	5180-00-610-8177	
16	F,H,D	TUBE SOCKET, ADAPTER KIT MX-1258/U	5835-00-378-5009	
17	H,D	TRANSMISSION MEASURING SET TS-559(*)/FT	6625-00-649-4286	
18	H,D	INDICATOR.PANORAMIC JP-173/U	5820-00-224-5500	
19	H,D	ANALYZER, SPECTRUM TS-723A/U	6625-00-668-9418	
20	H,D	OSCILLOSCOPE AN/USM-281A	6625-00-053-3112	
21	H,D	GENERATOR, SIGNAL TS-452D/U	6625-00-828-6410	
22	H,D	GENERATOR, 516NAL AN/USM-U	6625-00-669-4031	
23	H,D	TEST SET, TELEPHONE AN/USM-181	6625-00-740-0344	
24	H,D	TEST SET, RADIOFREQUENCY POWER AN/URM-120	6625-00-813-8430	
25	H,D	MODULATION, METER ME-57/U	6625-00-647-3737	
26	H,D	TEST SET, IF AN/GRM-63	6625-00-089-4653	
27	H,D	TEST SET, MODULATION IF AN/GRM-64	6625-00-089-4327	
28	H,D	TEST SET, NOISE LOADING AN/GRM-66	6625-00-089-4326	
29	H,D	TEST SET, RECEIVING FILTER AN/GRM-68	6625-00-089-4654	
30	H,D	DETECTOR, RADIO FREQUENCY DT-149/U (P/O TOOL CODE	6625-00-245-9619	
31	H,D	20)	5986-00-831-5991	
32	H,D	ATTENUATOR, VARIABLE CN-796/U	6625-00-868-8352	
33	H,D	GENERATOR, SIGNAL AN/URM-103	6625-00-720-2495	
34	F,H,D	ANALYZER, SPECTRUM AN/URM-110	6625-00-788-9672	
35	H,D	GENERATOR, SIGNAL AN/USM-205	6625-00-649-5193	
36	D	GENERATOR, SIGNAL AN/URM-25D	6625-00-566-4990	
37	O,F,H,	WATTMETER AN/URM-98/U	6625-00-519-2414	
38	D,	REGULATOR, VOLTAGE CN-514/GRC(P/O AN/GRC-50)	6625-00-973-3986	
39	D	VOLTMETER, R F AN/URM-145	5820-00-889-0857	
	F,H,D	POWER SUPPLY PP-2054(*)/GRC (P/O AN/GRC-50)		

SECTION III TOOL AND TEST EQUIPMENT REQUIREMENTS
 FOR
 RADIO SETS AN/GRC-50(V)1 THRU 5
 AND AN/GRC-50a (V)1 THRU 11

TOOL OR TEST EQUIPMENT REF CODE	MAINTENANCE CATEGORY	NOMENCLATURE	NATIONAL/NATO STOCK NUMBER	TOOL NUMBER
40	O,F,H,D	DUMMY LOAD, ELECTRICAL DA-189/GRC (P/D AN/GRC-50)	5820-00-892-3861	
41	D	TEST SET, RF AN/GRM-62	6625-00-935-4201	
42	D	TEST SET, AUDIO AN/GRM-65	6625-00-935-1500	
43	D	TEST SET, POWER SUPPLY AN/GRM-67	6625-00-935-4200	
44	D	SLOTTED LINE, COAXIAL IM-92/U	6625-00-692-6558	
45	D	COMPARATOR, FREQUENCY CM-77/USM	6625-00-788-3780	
46	D	GENERATOR, SIGNAL SG-321B/U	6625-00-674-7097	
47	D	INDICATOR, STANDING WAVE RATIO AN/UPM-103 (*)	6625-00-682-4494	
48	O,F,H,D	HANDSET H-156/U (P/O AN/GRC-50)	5965-00-892-3850	

NOTE
 IF NOT AVAILABLE, USE FOLLOWING

AN/URM-49 NSN 6625-00-669-5131
 OR
 AN/URM-49ANSN 6625-00-553-7386
 AN/URM-64 NSN 6625-DO-283-9621
 OR
 AN/URM- 64A NSN 6625-00-553-D433

SECTION IV. REMARKS

REFERENCE CODE	REMARKS
A	EXTERIOR ONLY
B	INTERIOR OF EQUIPMENT BUT EXTERIOR OF SUBASSEMBLIES
C	ALL INSPECTION
D	OPERATIONAL TEST ONLY
E	THOSE TESTS REQUIRED TO LOCATE FAULTY SUB-ASSEMBLIES, 3A1A1 OR 3A1A2, OR 3A1A3, OR 3A1A4, OR 3A1A5, OR 3A1A6, OR COMPONENTS MOUNTED ON MAIN CHASSIS
F	THOSE TESTS REQUIRED TO LOCATE FAULTY TUBES, FUSES, CABLES AND AMPLIFIER CONVERTERS AND OSCILLATORS
G	THOSE TESTS REQUIRED TO LOCATE FAULTY COMPONENTS IN SUBASSEMBLIES, 3A1A1/3A2A1, 3A5, 2A5 2A4/3A4 ONLY
H	ALL TESTS
I	ALL ALIGNMENTS
J	ALL SERVICING
K	OPERATOR ADJUSTMENT ONLY
L	ALL ADJUSTMENTS
M	THOSE ADJUSTMENTS AS OUTLINED IN TM 5820-461-12, PAR 5-13
N	THE FOLLOWING SUBASSEMBLIES ONLY: 3A1A1/3A2A1, 3A5 2A5, 2A4/3A4
O	THOSE ADJUSTMENTS AS OUTLINED IN TM-11-5820-461-35
P	ALL REPAIRS
Q	BY REPLACEMENT OF SUBASSEMBLIES AND COMPONENTS MOUNTED ON MAIN CHASSIS
R	BY REPLACEMENT OF COMPONENTS IN THE FOLLOWING SUBASSEMBLIES ONLY 3A1A1/3A2A1, OR 3A5, OR 2A5 OR 2A4/3A4, 2A3, 2A5, 2A6
S	ALL REPAIRS, INCLUDING REPLACEMENT OF TUBES 3A1V1 OR 3A2V1 IF NECESSARY PLUS SHOP SUPPORT
T	ALL REPAIRS EXCEPT REPLACEMENT OF TUBES 3A1V1 OR 3A2V1
U	THOSE SPECIAL ASSIGNED SHOPS AUTHORIZED
V	THOSE SHOPS AUTHORIZED TEST SETS AN/GRM-62,63,64,65,66,67,68
W	BY REPLACEMENT OF LIGHTING ARRESTERS, CABLES 2A4, CAPACITOR 3A5C2 TUBES, FILTERS, KNOBS, LAMPS, AND FUSES, CRYSTALS
X	BY REPLACEMENT OF SUBASSEMBLIES 3A1A1/3A1A2, 3A3, 3A4, 3A5, AND 3A6 AND COMPONENTS LOCATED ON MAIN CHASSIS
Y	THOSE TESTS REQUIRED TO LOCATE FAULTY TUBES AND CABLES
Z	

SECTION IV. REMARKS

REFERENCE CODE	REMARKS
AA	THOSE TESTS REQUIRED TO LOCATE FAULTY SUBASSEMBLIES 3A1A1 OR 3A1A2
AB	BY REPLACEMENT OF TUBES EXCEPT(3A1V1 and 3A2V1), CABLES AND KNOBS
AC	BY REPLACEMENT OF SUBASSEMBLIES 3A1A1 OR 3A2A1
AD	BY REPLACEMENT OF 3A1A2 AND COMPONENTS MOUNTED ON MAIN CHASSIS
AE	THOSE ADJUSTMENTS USING TEST SET AN/GRM-63
AF	THOSE TESTS REQUIRED TO LOCATE FAULTY SUBASSEMBLIES 2A3, 2A4 2A5 2A6 AND COMPONENTS MOUNTED ON MAIN CHASSIS
AG	THOSE TESTS REQUIRED TO LOCATE FAULTY COMPONENTS IN 2A3, 2A4, 2A5, 2A6
AH	BY REPLACEMENT OF SUBASSEMBLIES 2A3, 2A4, 2A5, 2A6 AND COMPONENTS LOCATED ON MAIN CHASSIS
AI	THOSE TESTS REQUIRED TO LOCATE FAULTY COMPONENTS
AJ	BY REPLACEMENT OF COMPONENTS
AK	BY REPLACEMENT OF ITEM

TM 11-5820-461-12

By Order of the Secretary of the Army:

HAROLD K. JOHNSON
*General, United States Army ~
 Chief of Staff.*

Official:

KENNETH G. WICKHAM,
*Major General, United States Army
 The Adjutant General.*

Distribution:

Active Army:

USASA (2)	USAIS (2)		
CNGB (1)	USAE8 (2)		
CC-E (7)	WRAMC (1)		
DIR of Trans (1)	Army Pic Cen (2)		
CofEngrs (1)	INSTL (2) except		
TSG (1)	Ft Hancock (4)		
CofSptS (1)	Ft Gordon (10)		
USACDCEA (1)	Ft Huachuca (10)		
USACDCCBRA (1)	Ft Carson (25)		
USACDCCEA (1)	Ft Knox (12)		
USSACDCOA (1)	Gen Dep (2)		
USACDOQMA (1)	SIG Sec, Gen Dep (5)		
USACDCTA (1)	SIG Dep (12)		
USACDCADA (1)	Army Dep (2) except		
USACDCARMA (1)	LBAD (14)		
USACDCAVNA (1)	TOAD (14)		
USACDCARTYA (1)	LEAD (7)		
USACDCSWA (1)	SVAD (6)		
USACE)CCEA, Ft Huachuca (1)	NAAD (6)		
USAARENBD (2)	SAAD (30)		
USAMC (5)	CHAD (3)		
USCONARC (6)	ATAD (10)		
ARADCOM (5)	SHAD (3)		
ARADCOM Rgn (2,	WSMR (5)		
OS MAJ Comd (4)	Sig FLDMS (3)		
LOGCOMD (2)	AMS (1)		
USAMICOM (4)	USACCREL (2)		
USASTRATCOM (4)	USAERDAA (2)		
USAESC (85)	USARERDAW (13)		
USACDCEC (10)	Units org under fol TOE (2 EA)		
MDW (1)	7	11-98	
ARMIES (2) except	11 -6	11-117	
Seventh (10)	11-7	11-165	
EUSA (10)	11-35	11-167	
Corps (2)	11-36	11-158	
USAC (3)	11-39	11-225	
USATC (2)	11-5B	11-377	
Svc Colleges (2)	11-57	11-500 (AA-AC)	(RH-RT)
USASCS (5)	11-86	11-587	
USASESCS (5)	11 86	11-592	
USAADS (2)	11-57	11-697	
USAAMS (2)	11-95	17	
USAARMS (2)	11-97	27	

NG. State AG (3)

USAR: None

For explanation of abbreviations used see AR 320 50

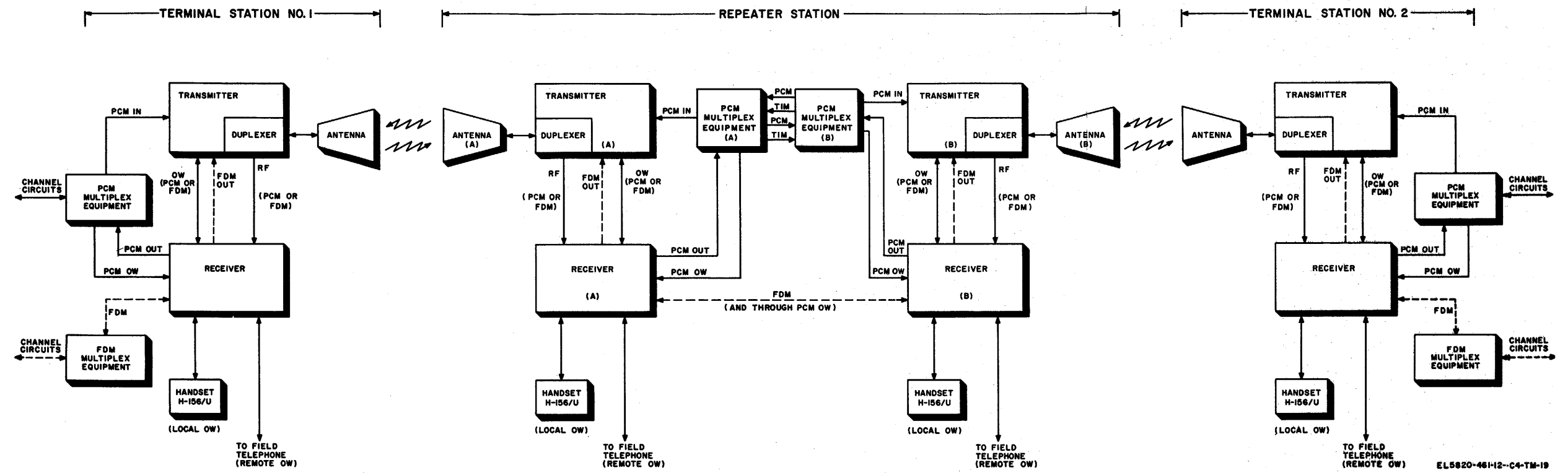

Figure 6-1. Radio Set AN/GRC-50 (*) V, repeater system application

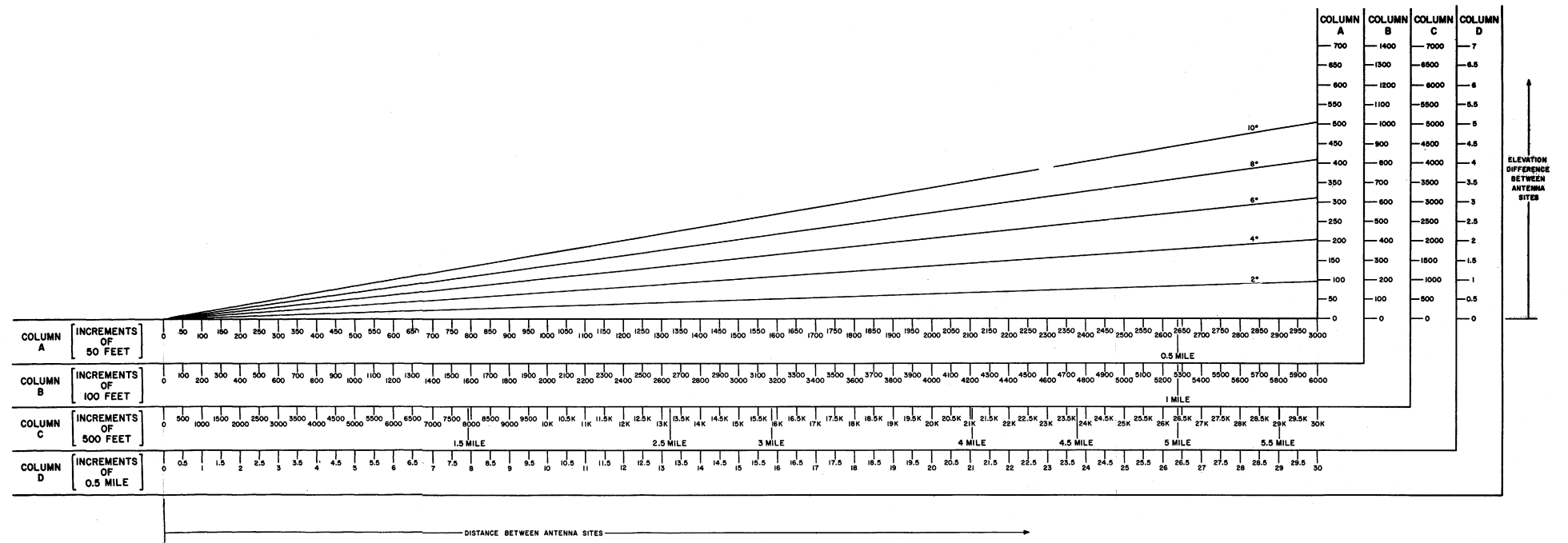

Figure 6-2. Antenna depression-elevation angles

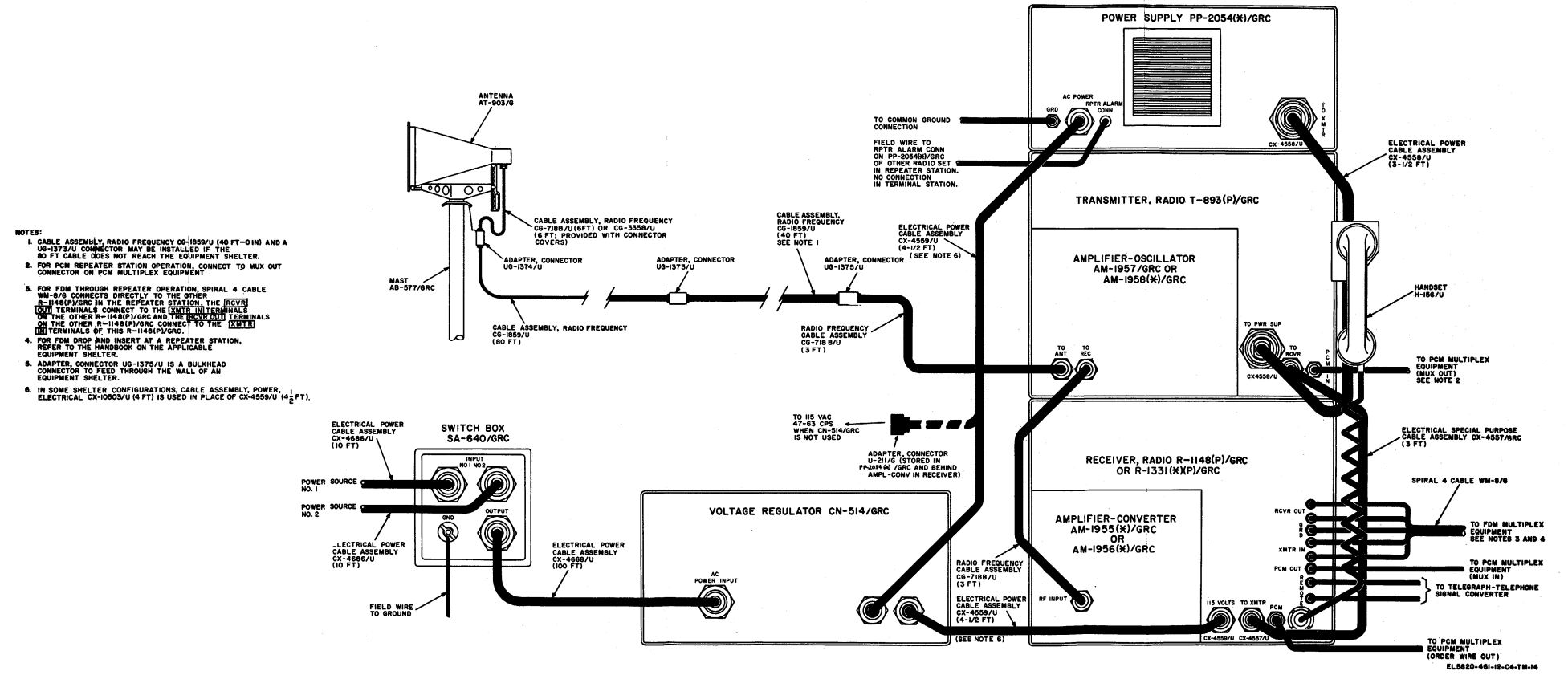

Figure 6-3. Typical interunit cable connections

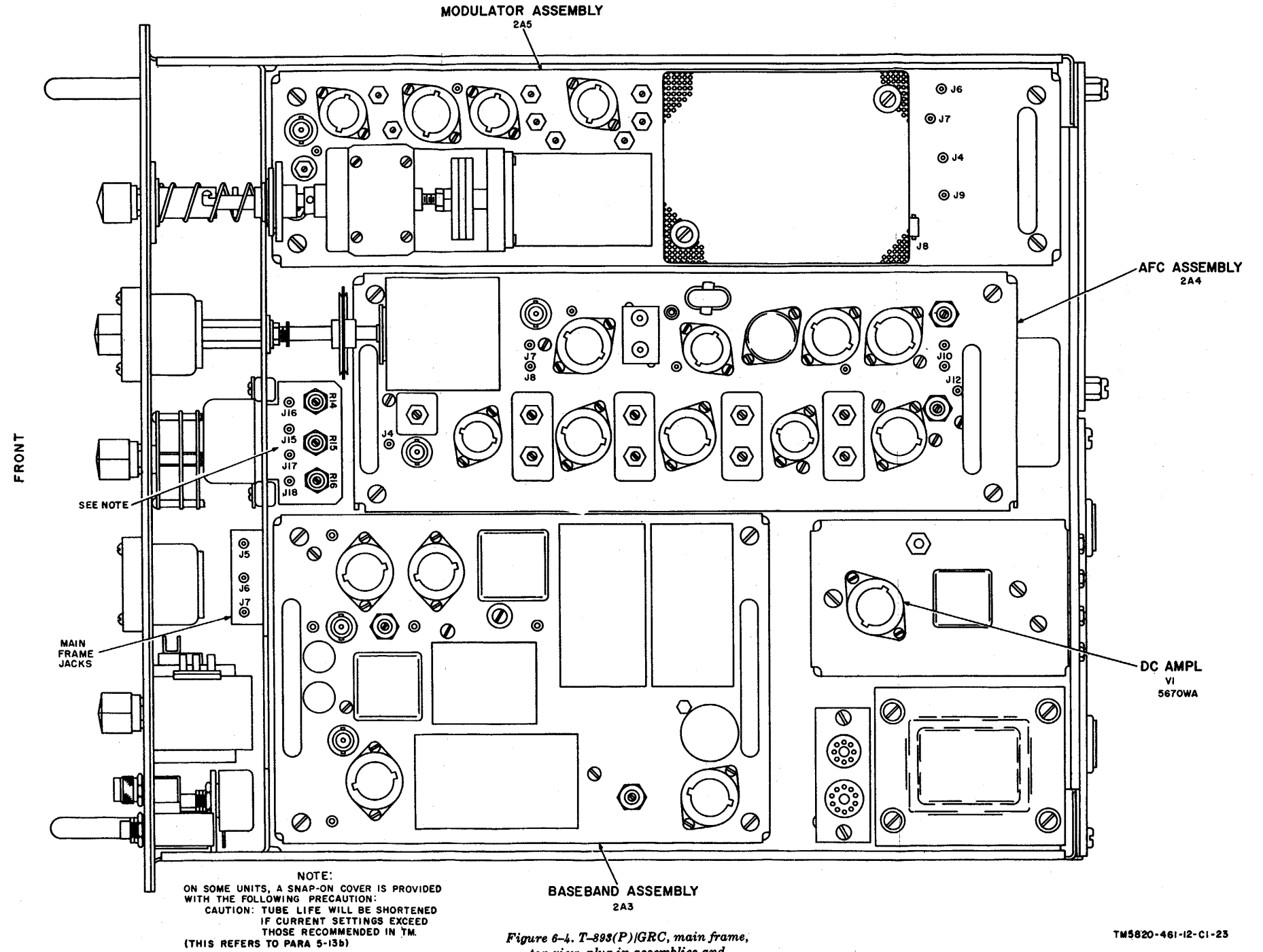

Figure 6-4. T-893 (P)/GRC, main frame, top view, plug-in assemblies and test points

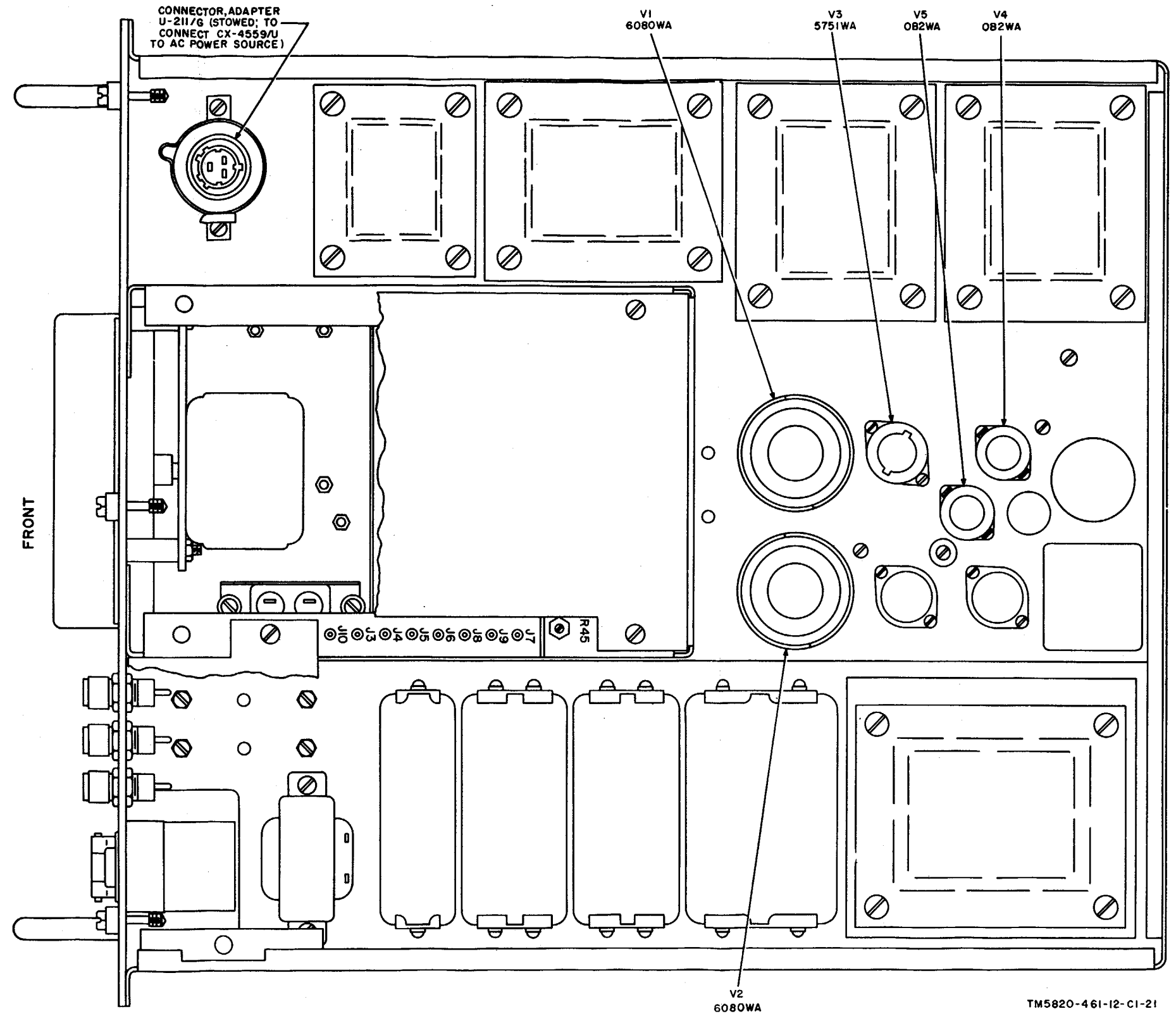
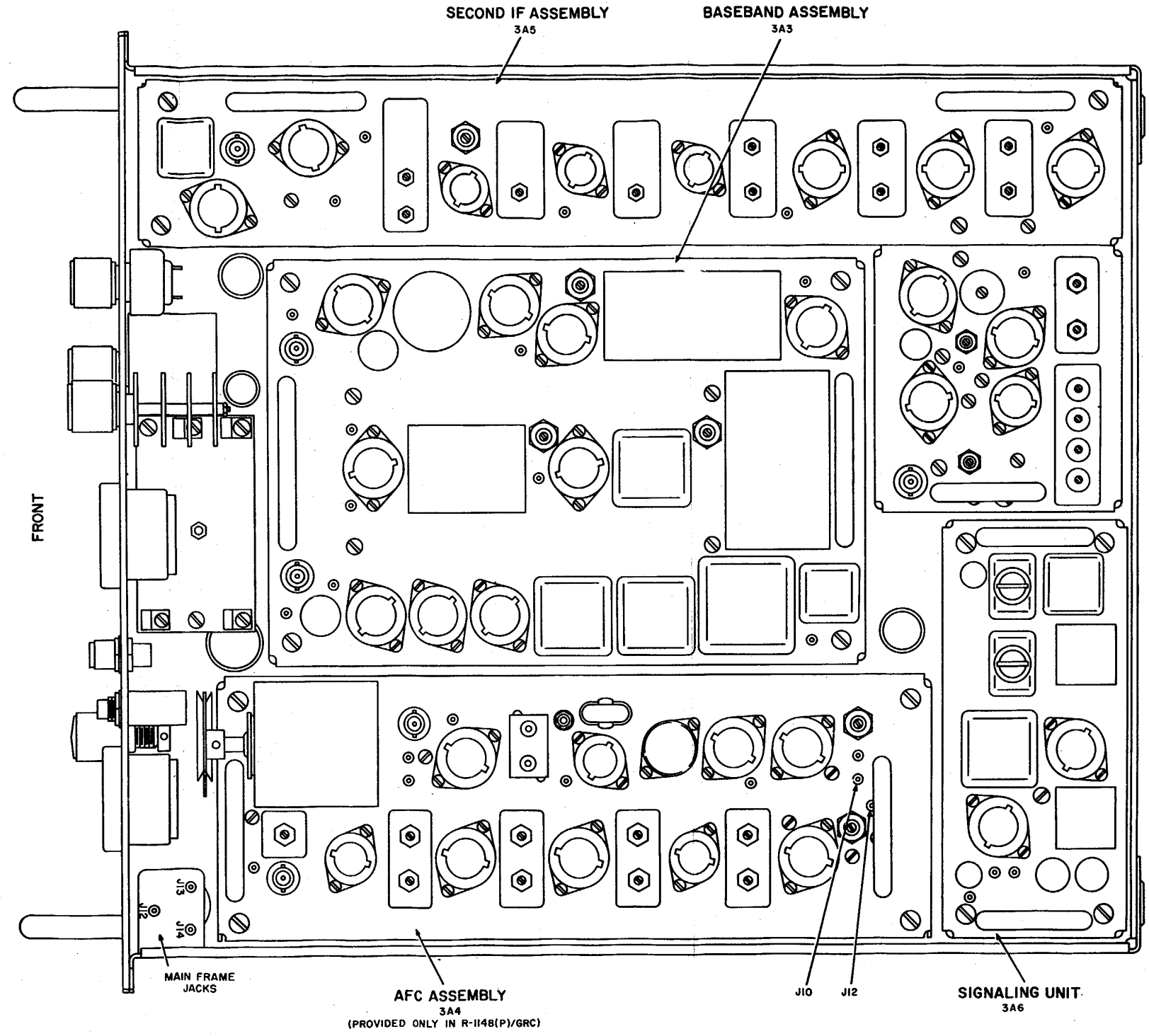
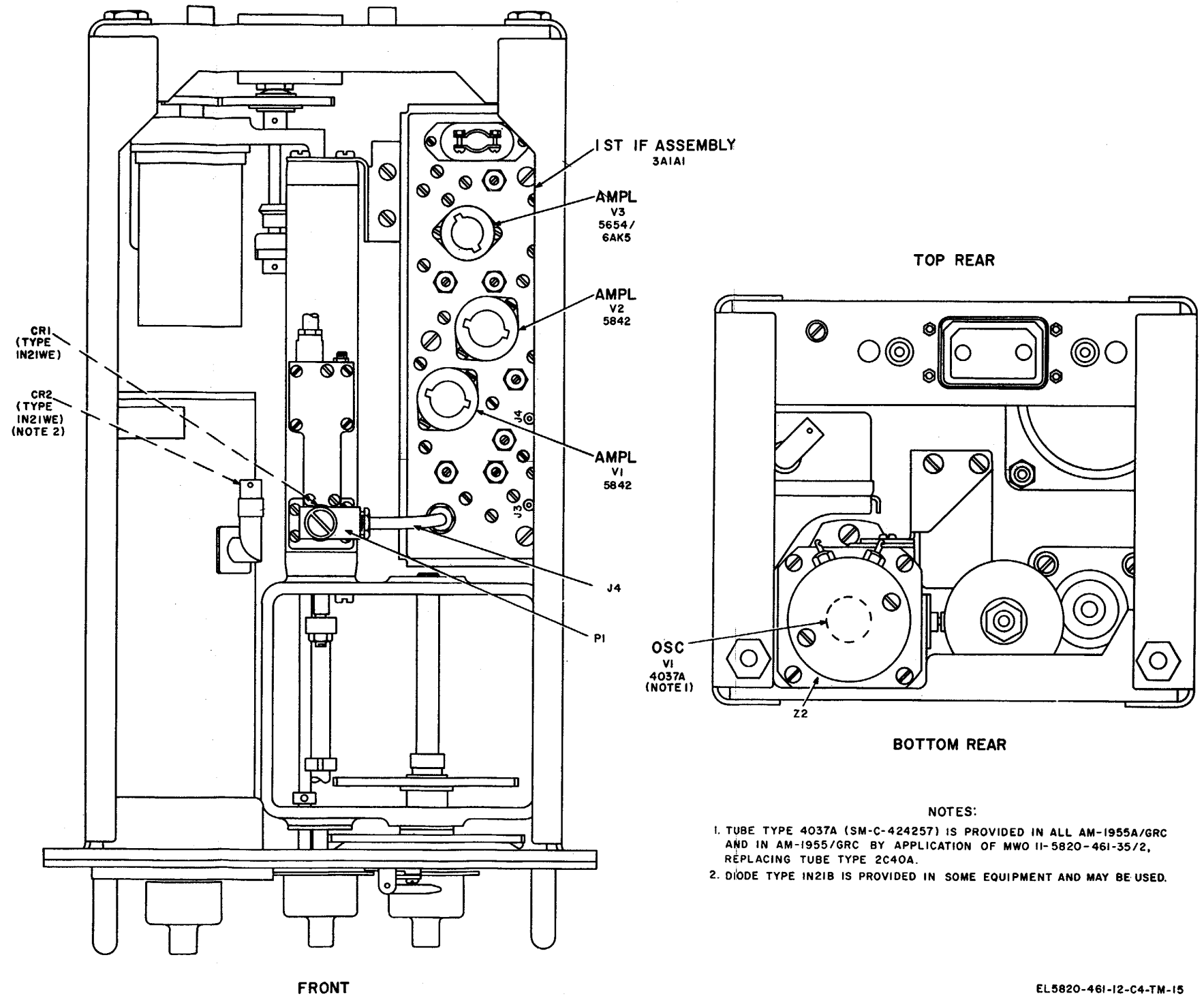

Figure 6-5. PP-2054(*)/GRC, top view, tube and test point locations



TM5820-461-12-CI-32

Figure 6-6. R-1148(P)/GRC or R-1331(*) (P)/GRC, top view, plug-in assemblies and test point locations



EL5820-461-12-C4-TM-15

Figure 6-7. AM-1955(*)/GRC, tube and test point locations

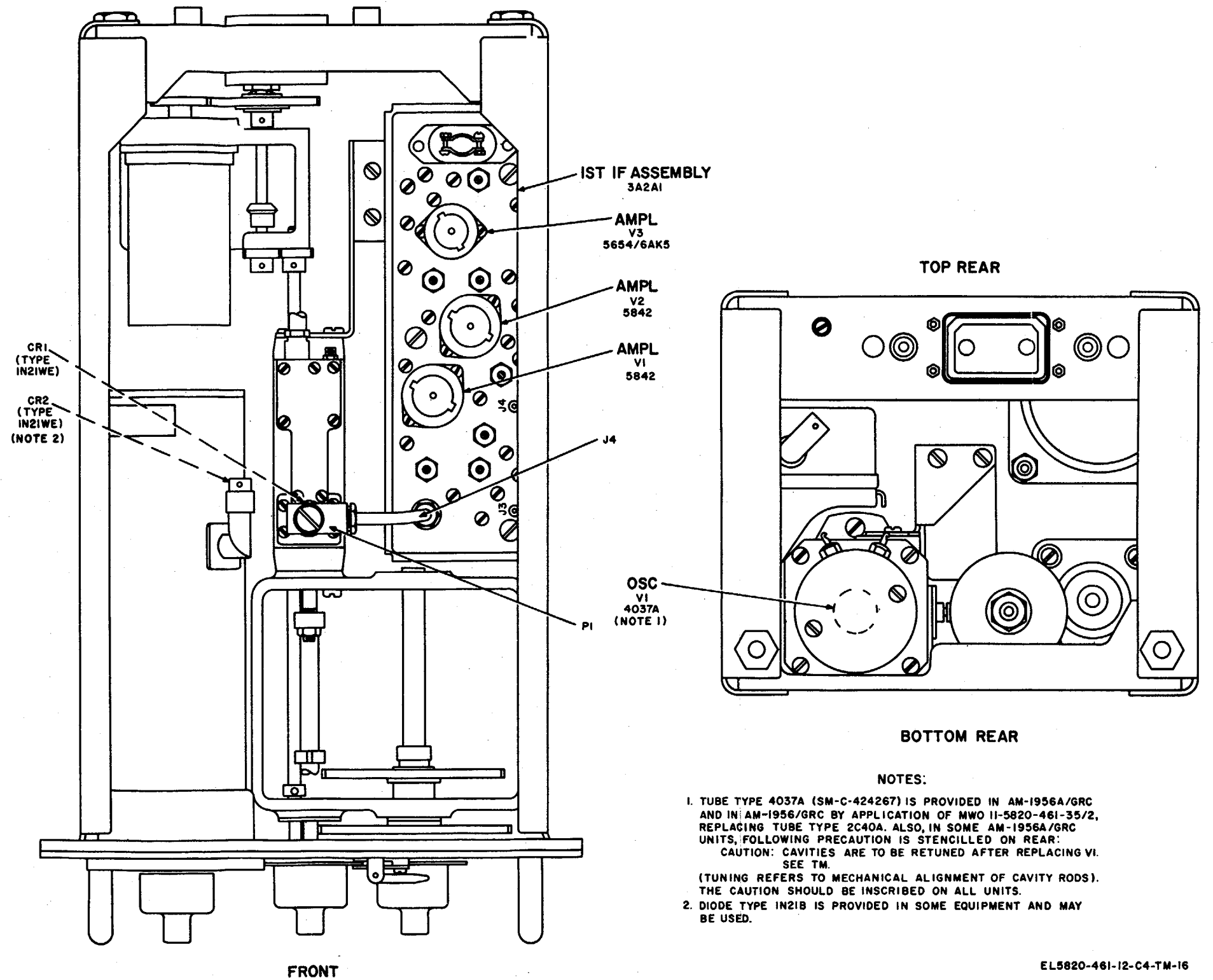

EL5820-461-12-C4-TM-16

Figure 6-8. AM-1956(*)/GRC, tube and test point locations

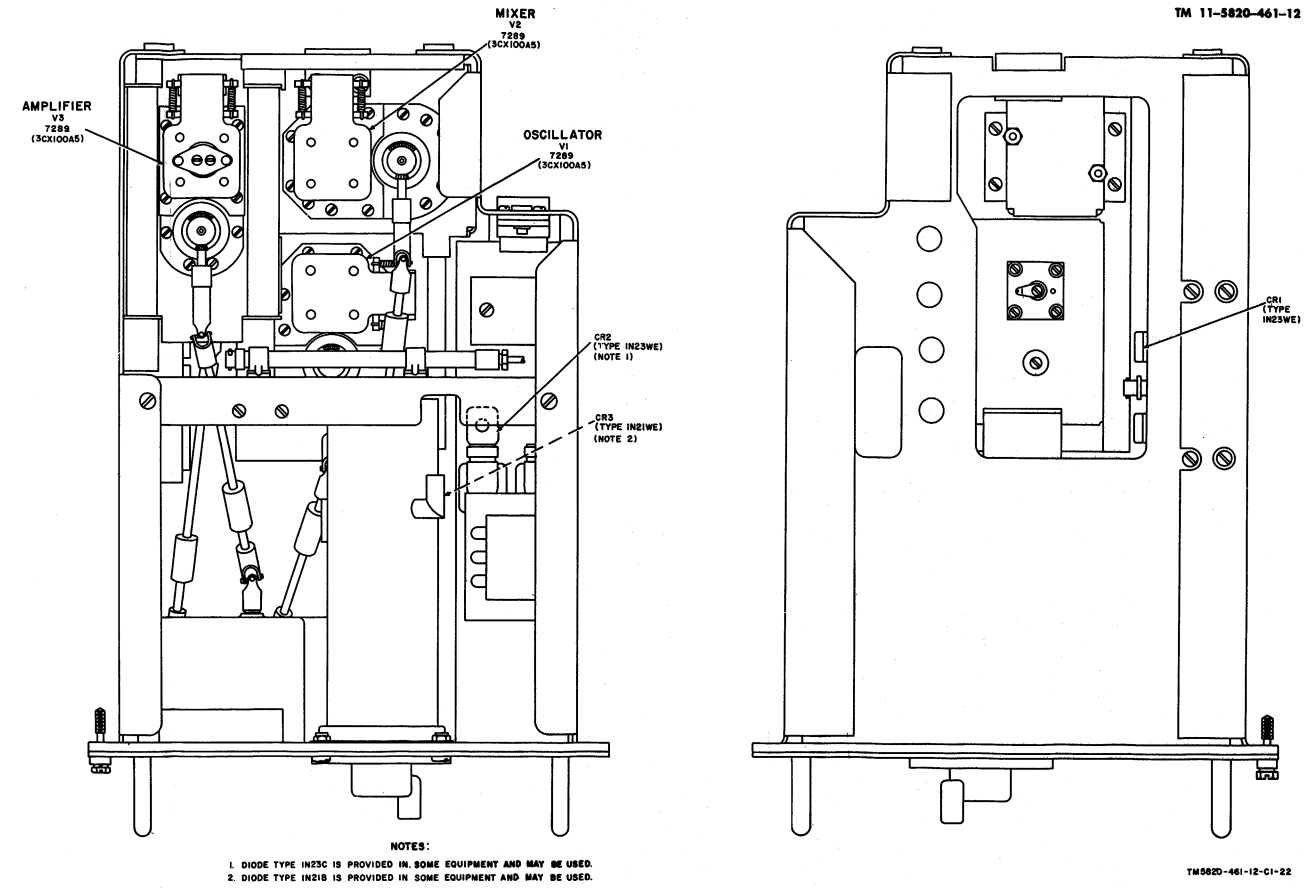

Figure 6-9. AM-1956(*)/GRC, tube and crystal diode locations.

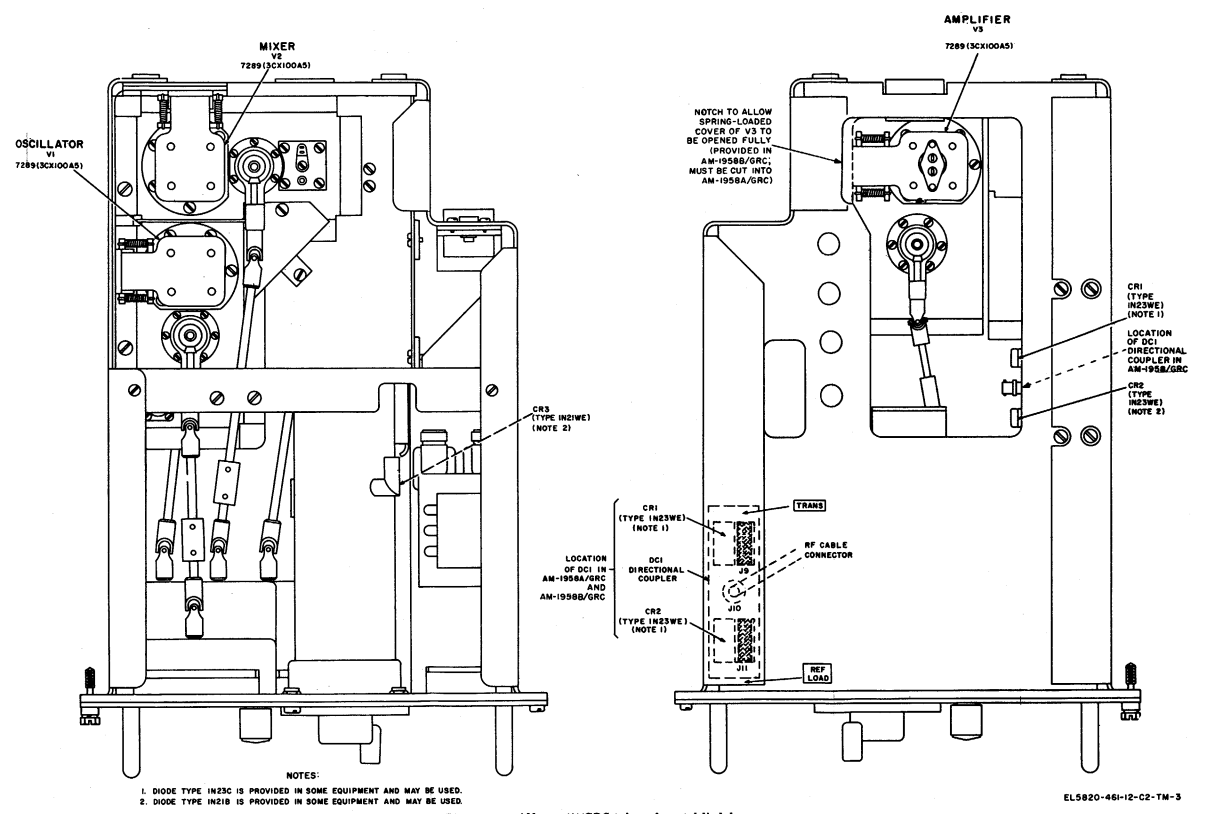

Figure 6-10. AM-1956(*)/GRC, tube and crystal diode locations.

RECOMMENDED CHANGES TO EQUIPMENT TECHNICAL PUBLICATIONS



THEN...JOT DOWN THE
DOPE ABOUT IT ON THIS FORM.
CAREFULLY TEAR IT OUT, FOLD IT
AND DROP IT IN THE MAIL.

SOMETHING WRONG WITH PUBLICATION

FROM: (PRINT YOUR UNIT'S COMPLETE ADDRESS)

DATE SENT

PUBLICATION NUMBER

PUBLICATION DATE

PUBLICATION TITLE

BE EXACT PIN-POINT WHERE IT IS

PAGE
NO.

PARA-
GRAPH

FIGURE
NO.

TABLE
NO.

IN THIS SPACE, TELL WHAT IS WRONG
AND WHAT SHOULD BE DONE ABOUT IT.

PRINTED NAME, GRADE OR TITLE AND TELEPHONE NUMBER

SIGN HERE

